



UKAL

AGRI

LIVESTOCK EXPERT | 2023



[UKAL.com](https://www.ukal.com)

UKAL AGRI

LIVESTOCK EXPERT

The legacy of a passion.

The world is changing. Consumers' expectations and the farmers' concerns of have evolved, bringing about a slow but progressive shift in the farming sector and even throughout society as a whole.

We constantly adapt to these changes by offering new products. This more comprehensive offer is a response, of course, to the expectations of livestock farmers, but also to those of gardeners, hobby farmers and, at the end of the day, just about everyone else.

Confident in our expertise in the world of farming, we have constructed and segmented our offer in three main product lines - **UKAL AGRI**, **UKAL GREEN** and **UKAL TECH** - to continue to perpetuate our heritage whilst embarking on a new chapter in the life of our firm.

Because mankind will always need food, we will continue to advise and assist those generations of farmers and livestock specialists passionate about their profession.

Our mainstay since we were founded 55 years ago, the **UKAL AGRI** division has changed and adapted constantly over the years and will continue to be our core business. Our go-to partnerships with horizont, Heiniger and more than 48 other brands position us as an essential player on the livestock farming market. In our capacity as a specialist in livestock farming, we make a point of honour of always being innovative, offering value-for-money products that improve animal welfare and simplify the livestock farmer's day-to-day life.

Along with our **After Sales Service**, which can supply a great many spare parts and offers a repair service, it is our wish to extend the lifespan of the products that we sell.



DISCOVER THE EXPLICATIVE-
VIDEO OF OUR 3 DIVISIONS



UKAL

— SUMMARY

05	Cattle
49	Sheeps
61	Pigs
65	Poultry
89	Heating
93	Identification
103	Electric clippers
117	Vaccination & drenching
125	Farm & stable equipment
153	Milk & meat processing
167	Hygiene & farmer protection
175	Fencing - Beaumont
201	UKAL TECH selection



UKAL

THE UKAL WEBSHOP

More than **6000** product references

More than **2000** spare parts available from our after sales service

Fast ordering **simply** by uploading an Excel file

Online **fence calculator**

Merchandising tools can be ordered

Store locator

with a listing of retail outlets

All safety data sheets are available on our website.

QUICK AND EASY
PLACE YOUR ORDERS
24 / 7!



CHECK OUT THE VIDEO
ON OUR WEBSHOP BY SCANNING
THIS QR CODE

CONTACT US
to get your login code!

—
**TOOLS
FOR SALE**

*Build your
product offer*

Find all our brochures in the
the "Our catalogs" section
on **UKAL** webshop.



UKAL

**THE POWER
OF AN EUROPEAN GROUP**

—

UKAL.com



Bio EUTRA

THE FIRST ORGANIC
MILKING GREASE!



Organic
beeswax



Organic
sunflower
oil



100% NATURAL INGREDIENTS.
Organic beeswax and organic sunflower oil.



Available on **UKAL.com**



—
CATTLE

06	Calving
29	Care
10	Feeding
20	Magnets
21	Dehorning
24	Castration
25	Restraining
28	Leads and halters
31	Collars
32	Hoof Care
38	Dairy
44	Hygiene
45	Brushes
47	Bells



MOOCALL CALVING SENSOR

MooCall's calving sensors measure contractions and predict when your cows will calve. This non-invasive, tail-mounted sensor collects hundreds of pieces of data per second. It can accurately predict when your cow is most likely to calve by measuring tail movements triggered by labour contractions. When the contractions reach a certain level of intensity, over a period of time, the sensor sends an SMS alert directly to your mobile phone, on average, 1 hour before calving.

DOES NOT WORK FOR HORSES.

THE ADVANTAGES OF MOOCALL - CALVING SENSOR:

- Connects easily with all networks and phones (GSM signal).
- No need for wifi, stations, router or extra batteries.
- Notification 1 hour before calving by SMS, email and App notification.
- Free application.
- One year warranty.

Non-invasive.

- Cost compensated with about 30 cows.
- Reduces calf and cow mortality.
- After-sales service available by various means.

After one year, an annual fee applies to keep the unit active. The annual fee for the second year is payable directly to MooCall HQ. Annual renewal covers 12 months of unlimited calving alerts, software updates, service and support. The customer can also extend the warranty for a second year. Please note that MOOCALL is not geolocatable.

Sku. MO034716



CALVING JACK BEEF CATTLE Vink

Pulling power **500 kg** (1'100 lbs). For corpulent suckling-cows. The 1,80 meter (5'4") tube provides an efficient support for calving even for very big calves. It is also suitable for hanging the calf upside down to clear out the respiratory tracts.

Sku. 101011



Pulling power: 500 kg



CALVING JACK DAIRY CATTLE Vink

Pulling power **300 kg** (660 lbs). Allows a higher freedom of action as well as a high tension and an alternate motion of the two straps. Made of stainless steel.

Sku. 101010001



Pulling power: 300 kg



UNIVERSAL CALVING ROPES UKAL

Made of nylon. 66 cm (26") long. Adaptable for all types of calving jacks. Supplied in pairs.

Sku. 101103



White
Limited stock



VINK CALVING ROPES Vink

Made of nylon. Diameter of 12 mm (1/2"). Supplied in pairs.

Sku. 101104



Red and blue

COTTON CALVING KAMER ROPES WITH RING

55 cm (27") long. Diameter 12 mm. Very soft. The cotton avoids shearing. Supplied in pairs.



Sku. 101105



White



NYLON CALVING KAMER ROPES WITH RING

Length: 43 cm (17"). Diameter 12 mm. Supplied in pairs.



Sku. 101106



White



NYLON CALVING KAMER STRAPS

Suitable for calving ropes. After placing the rope through the metal ring, the large strap can be fastened on the leg of the cattle. The strap avoids shearing. Supplied in pairs.



Sku. 101123



Nylon assorted colors
Limited stock



PERLON CALVING KAMER CORD 2 M

Diameter of 7 mm. For calving. Available in several colours. Using different colours during the calving makes it possible to identify the legs and to adjust the traction according to the calving need.

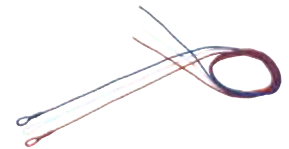

Sku. 101107036



One blue and one red



BLANKET FOR CALVES

UKAL

For optimal strengthening of the calf's immune system in the days after birth. Prevents diarrhoeal diseases. Breathable and moisture-resistant fabric 3 layers of protection with insulation for a better comfort of the calf. Long and adjustable straps. Machine washable at 30°C. Pocket with velcro fastening on the right side for the use of heating pads (not included). Length: 72 cm.



Sku. 101130



By piece

COW LIFT

KAMER

Suitable model for dairy and beef cattle. The clamps prevent injuries thanks to its rubber foam covering. Double thread and triple tubing for a better resistance. Very simple to adjust. Helps weak cattle to stand up (after a difficult calving, for deficient animals). Maximum weight: **900 kg** (1984 lbs).



Sku. 104453



Grey - Maximum weight 900 kg (1984 lbs)





— COW LIFT



Cow lift robust and stable for cows up to **1500 kg**. A wise investment that pays off quickly and should be a "must" for every dairy farmer. An indispensable apparatus for cows that cannot get up. The clamps are adjustable to the size of every cow. With a pulley or a hoist you can help the cattle to get up.

Sku. 104456



Maximum weight
1500 kg



— PROLAPSE HARNESS

KAMER

It is used to keep the uterus in place in case of a prolapse. In leather.

Sku. 101110



Leather
Limited stock



— NICKEL - PLATED KAMER PROLAPSE NEEDLES

Used to keep the uterus remain in place in case of a prolapse. Nickel-plated. 13 cm.

Sku. 101113



Without eyelet, by 5
Limited stock

Sku. 101113A



With eyelet, by 5
Limited stock



— SEPTICARE LUBRICATING GEL



Lubricating gel ideal for lubricating the arms and hands for rectal and vaginal examinations.

Sku. 101212110



1000 ml . Spermicidal



— SEPTIJECT



Septiject is a cleaning solution for external use to clean and dry superficial wounds on farm animals. Professional use only.

Sku. 002007





Spray 500 ml



ELECTRONIC VETERINARY THERMOMETER WITH SIGNAL

UKAL

Digital display from 32°C to 43°C. Audible signal to indicate the temperature calculated.

Sku. 114062 Electronic veterinary thermometer with signal  





NEW

LARGE DISPLAY THERMOMETER

UKAL

Digital display. Measuring time approx. 20 seconds. Measuring range: 32,0 °C ~ 43,9 °C. Operates with one 3V lithium button cell battery (CR2032) included. Material ABS + TPE and stainless steel. Soft tip.



Sku. 114064 Assorted colors  



DIGITAL VETERINARY THERMOMETER

UKAL



Measurement from +32°C to +44°C with an accuracy of +/-0.1°C. Automatic shut-offn after 15 seconds. With suspension ring and cord. Supplied in blister pack with manual.

Sku. 114063 Digital veterinary thermometer  



STETHOSCOPE

With 22" (56 cm) PVC tubing. Y shape. Eartips made of polyethylene.

Sku. 114100 Assorted colors **Limited stock**  



UNIVERSAL SCISSORS MULTI-USE

KAMER

Very good cut multi-use: hair, bands, umbilical cord...

Sku. 114025 Multi-use  



ARTERY FORCEPS

KAMER

Used when suturing.

Sku. 114080 Artery forceps  



CATTLE | Feeding



Tétiblué

FEEDING BUCKET 8 LITERS

Plastic feeding bucket is graduated. Very resistant. It is equipped with a sloping bottom so that all the milk is consumed. Supplied with handle, teat holder, teat. Food grade plastic, non-toxic. Hygienic, easy to clean. The transparent plastic version allows you to effortlessly check the level of remaining milk. Supplied without lid and bracket.

Sku. 120009630 

Transparent complete feeding bucket

Sku. 120009600 

Blue complete feeding bucket



Tétiblué

CALF FEEDING BUCKET

Supplied without teat and teat holder. Food safe quality.

Sku. 120009632 

Transparent bucket

Sku. 120009601 

Blue bucket



Tétiblué

TEAT HOLDER

With washers included.

Sku. 120009610 

Blue

Sku. 120009612 

Grey



Tétiblué

COMPATIBLE TEAT

Work for TETIBLUE and TETICLEAR buckets. Length: 10 cm.

Sku. 120009635 

Red by 3

Sku. 120009500 

Sand by 2



Tétiblué

TRANSPARENT LID

For TETIBLUE and TETICLEAR buckets.

Sku. 120009621 



Tétiblué

WASHERS

Sku. 120009625 

By 5

Sku. 120009626 

By 100



Tétiblué

METAL BRACKET FOR BUCKET

Sku. 120003004M 



Tétiblué

FLOATING CALF DUMMY LARGE

The characteristic of this base is the ability to float with the teat oriented upwards. With its round form it is very steady and unsinkable. It has been specially designed for trough-feeding systems. The stainless steel washer ensures a perfect balance of the base. It is embedded in the valve and can't get in contact with the food. Cleaning and replacement of the base can be done easily and rapidly. Supplied with a teat 120009300.

Sku. 120009



Diameter: 120 mm.
Height: 130 mm



Tétiblué

FLOATING DUMMY MEDIUM

The characteristic of this base is the ability to float with the teat oriented upwards. The double clamp ring avoids milk permeation, which ensures the sealing and the cleanliness of the base. It is very practical, easy to dismantle and to clean due to its special design. The calf is able to drink all the milk contained in the bucket.

Sku. 120009001



Diameter: 80 mm.
Height: 130 mm



Tétiblué

SINKING DUMMY

After the milk bucket is filled, this base sinks to the bottom of the bucket. The teat of this sinking base remains constantly facing upwards, thanks to the inclusion of a stainless steel ring in the centre of the valve. The replacement of the teat is practical and quick.

Sku. 120009002



Diameter: 75 mm.
Height: 130 mm



Tétiblué

FLOATING CALF DUMMY SMALL

The characteristic of this base is its ability to float with the teat facing down. The plastic part does not contain a balancing element, which forces the calf to look for the teat from the sides. It is extremely practical and easy to disassemble for cleaning.

Sku. 120009003



Diameter: 74 mm.
Height: 130 mm



Tétiblué

SPARE TEAT

Colour: Red. Compatible with all floating dummies TETIBLUE except Sku. 120009. Shore 42.

Sku. 120009200



Diameter: 43 mm.
Height: 92 mm



Compatible with:



Tétiblué

SPARE TEAT

Colour: Sand. Diameter of hole: 3 mm. Compatible with floating dummy Sku.120009. Shore 50..

Sku. 120009300



Diameter: 46 mm.
Height 120 mm



Compatible with:



Tétiblué

SPARE TEAT

Colour: Sand. Compatible with all floating dummies TETIBLUE except Sku. 120009. Shore 50.

Sku. 120009100



Diameter: 43 mm.
Height: 92 mm



Compatible with:



Tétiblué

SPARE TEAT

Colour: Sand. Size: 45 x 100 mm. Compatible with all floating dummies TETIBLUE except Sku. 120009. Shore 50.

Sku. 120009110



Diameter: 45 mm.
Height: 100 mm



Compatible with:







ALUMINIUM CALF DUMMY

Aluminium. Shore 50. Sand color. Supplied in pairs.

Sku. 120006  3 338020 010448

Aluminium calf dummy x 2 

Sku. 120007  3 338020 010455

Teat for aluminium calf dummy x 2 

Sku. 120007001  3 338020 010462

Spare aluminium base calf dummy, by unit 



STAINLESS STEEL CHAIN

Sku. 120007006  3 338020 048373

By unit



SMB CALF TEAT

They prevent leaking and assure a good flow so that the calf can suck without any difficulties. The «SMB» teat is suitable for all feeders with a 22 mm teat hole and also for the calf feeding bottle. Supplied in pairs.

Sku. 120038  3 700393 912191

SMB calf teat, by 2 



LATEX TEAT

For calf buckets and feeders.

Sku. 120005  3 338020 010431

Latex teats reinforced x 2 



SEMI-CIRCULAR PLASTIC BUCKET WITH LID 6 L

The collar ensures that there are no losses. Very good stability thanks to its flat back. This new model has a metal reinforcement around the lid for a better stability of the handle. Supplied without teat.

Sku. 120015  3 338020 026708

6 L

Sku. 1200241C  3 338020 042494

Rubber calf teat by 2



CIRCULAR PLASTIC CALF BUCKET 7 L

Plastic calf bucket, circular, 7 L. The cone shape allows full flow of milk. To be placed on a circular support for the feeding box. Supplied with: valve, 2 rubber teats (Sku. 1200241C) without support.

Sku. 120001  3 338020 037001

7 L

Sku. 120020  3 338020 041695

White valve by unit

Tétiblué

PLASTIC CALF FEEDER

With handle and teat. Food safe plastic. 250 ml scale. Supplied with rubber teat Sku. 120025. Sand colour. Possibility to adapt the teat for grains.

Sku. 120025001 

2 L complete (bottle + teat)

Sku. 120035001 

3 L complete (bottle + teat)

Sku. 120025 

Sand teat. Length: 10 cm. Supplied by piece

Sku. 120025006 

2 L bottle holder in metal

Sku. 120035006 

3 L bottle holder in metal



SPEEDY FEEDER

The speedy feeder is a 3 speed calf feeding bottle. The **3 speeds** control the air inlet to the bottle. A teat is mounted low in the cap to empty the bottle contents completely. **THE ORIGINAL!** Graduation every liter.

Sku. 120050 

2,5 L

Sku. 120056 

4 L

Sku. 120055 

Lid and teat SPEEDY FEEDER



SPEEDY DRENCHER

The **original** Speedy Drencher is a drenching bottle for calves with the same characteristics as the Speedy Feeder bottle: 3 feed rates, ergonomic handle, a bottle neck with large opening and a wide base for greater stability. The lid and the drenching probe are suitable for the Speedy Feeder bottle. The length of the probe is 48 cm. Great for colostrum.

Sku. 120090 

4 L

Sku. 120091 

SPEEDY drencher tip



COLOSTRUM SCALE

Helps to evaluate the quality of the colostrum.

Sku. 124062 

With test tube



ANTAHI COLOSTRUM REFRACTOMETER

Helps to evaluate the quality of the colostrum. Refractometer with automatic temperature compensation between + 10 ° C and + 30 ° C. Scale from 0 to 32 Brix.

Sku. 124070002 

Colostrum refractometer



UKAL'S TIP

The colostrum refractometer: what importance does it have for newborns?

Newborns don't have antibodies in their blood, which is a critical factor for the running of the immune system. Colostrum contains large quantities of antibodies and is the main source for the new born.

Colostrum reduces the risk of diarrhea and pneumonia and saves lives. Refractometers allow you to verify that the milk given to the new born is healthy. Did you know? Colostrum is the milk produced by the female mammals at the end of the gestation, it is the first milk consumed after delivery.



Based in the heart of New Zealand, Antahi develops innovative and efficient products. The best start = optimum health and productivity for life. Through our hands-on experience we know how to achieve this best start for your animals and we are here to help farmers and vets achieve top results in a kinder, easier, safer and easier manner, through better equipment. Why Antahi? An = animal and Tahi = first in Maori. If you look after your animals, they will look after you. Our products are designed to work with the animal, achieving the lowest stress and the greatest result, which in turn makes a farmers work and life easier.



2 in 1



— **TRUSTI TUBER**



Designed by a vet, the Trusti Tuber significantly reduces calf stress and discomfort. Flexi Tuber can be held in place with one hand. Large 4 liters capacity bottle. Transparent flexible tube makes it easy to clean and monitor flow. Ergonomic bottle handle. Perfect for large and small hands. Reliable valve. Fast flow even with thick colostrum. Shown in trials to almost halve procedure feeding time. Stopper and calf size markers provide easy guide for tube placement and positioning. **Attachment included with Flexi Tuber for use without hands.** Locking ring and calf weight indication for better positioning of the flexible tube (20 to 140 kg). Delivered with a teat for an easy transition between bottle and drenching.

Tip: Never let the liquid drain before the tube is placed in the esophagus.

Sku. 120095	TRUSTI TUBER 4 L		
Sku. 120096	FLEXI TUBER 4 L		

— **ANTAHİ FEEDER WITH TEAT**



A specially designed bottle for both bottle feeding with the Antahi Suckle Up cap, and tube feeding with the Antahi Tubers. What makes a bottle a better bottle? Well that depends on the user, in this case the farmers and calf rearers, so we asked them: What would you like in a bottle and what makes your job easier? The Antahi Feeder is the result. High quality valve for reliable flow and no leaks. 4 liters or 1 gallon size for less refilling. Wide cap for eas filling and easy cleaning. Clip-on mouthpiece for maintaining hygiene. Ergonomic design for both small and large hands. Broad base for uneven ground.

Sku. 120097	4 L		
--------------------	-----	---------------------------------------------------------------------------------------	---------------------------------------------------------------------------------------

COLOSTRUM BAGS ANTAHI

Large spout for easy filling and cleaning. Transparent side – see the colostrum contents, see the colostrum level reduce during feeding. Reusable – due to durability and easy to clean design, the Trusti colostrum bag is the only colostrum bag designed to be reused. (Number of uses dependant on cleaning and care of bag). Comfortable handle. Pasteurisation friendly. Large capacity – **four liters freezes flat**. Quick thawing. Incorporating premium Trusti Tuber and Flexi Tuber oesophageal tube feeders.

Sku. 120098100 

Box of 10 

Sku. 120098500 

Box of 50 



COMPLETE KIT FOR COLOSTRUM ANTAHI

Kit containing colostrum bags, a peach teat and a trusti tube.

Sku. 120095100 

4 bags + teat + trusti tube 

Sku. 120095200 

10 bags + teat + trusti tube 



BRUSH FOR COLOSTRUM BAGS ANTAHI

Allows an efficient cleaning of the colostrum bags.

Sku. 120098 

Stainless steel 



PASTEURIZER FOR ANTAHI COLOSTRUM BAGS

This pasteurizer is specially designed for pasteurization of colostrum bags. Easy to use, very precise and good value for money. This pasteurizer makes it easy to pasteurize colostrum in Trusti bags, it can keep the number and quality of antibodies in colostrum and avoid bacteriological contamination. 60 ° C = ideal temperature for pasteurizing; for 60 min. 42 ° C = temperature for defrosting. Heating: depends on the degree of water. Cooling: approx 30 min. The technical characteristics: Plastic material. Capacity: 2 bags of 4 liters at the same time Water capacity: 27 liters. Digital screen.

Sku. 120098300 

Pasteurizer for colostrum bags



THERMAL BAG FOR ANTAHI COLOSTRUM BAG

Insulated bag to keep colostrum warm when feeding or transporting.

Sku. 120098400 

Thermal bag for colostrum bag



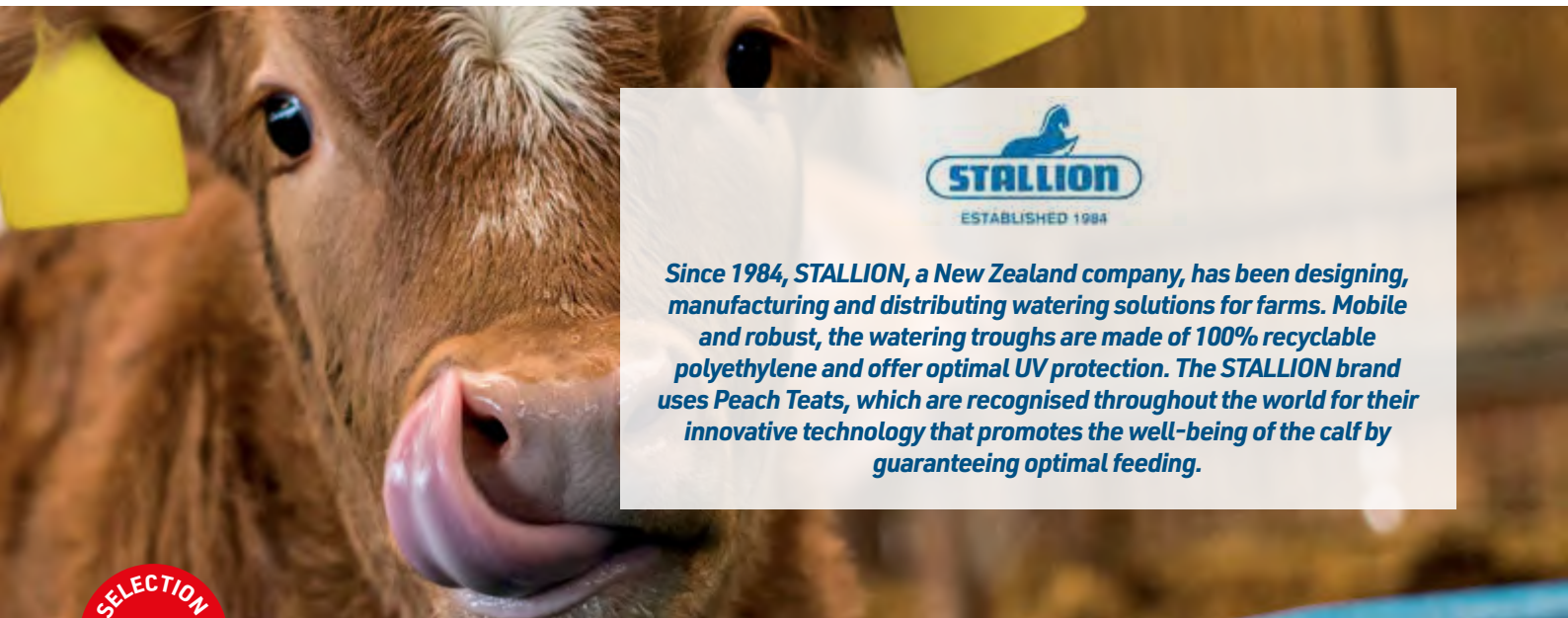

Since 1984, STALLION, a New Zealand company, has been designing, manufacturing and distributing watering solutions for farms. Mobile and robust, the watering troughs are made of 100% recyclable polyethylene and offer optimal UV protection. The STALLION brand uses Peach Teats, which are recognised throughout the world for their innovative technology that promotes the well-being of the calf by guaranteeing optimal feeding.



NEW

COMPARTMENTS CALF FEEDER

The Milk Maid series features a range of compartmentalized pen feeders available from 1 to 10 teat models. They are made of tough, durable plastic with rounded edges to make it easy for transporting and cleaning. Complete with steel brackets and screw in peach teats, they are easy to take off to ensure a hygienic clean.

Sku. 120018103 

MM3 - 3 peach teats - 16L

Sku. 120018105 

MM5 - 5 peach teats - 25L

Sku. 120018106 

Méga MM5 - 5 peach teats - 40L

Sku. 120018110 

Méga MM10 - 10 peach teats - 66 L



NEW

CALF FEEDER WITHOUT COMPARTMENTS

Stallion's range of pen feeders have been thoroughly tested and proven to effectively feed calves from first day through to weaning. A must for every calf rearer. Non-compartmentalized pen feeders. Easy to install with galvanised steel hooks. Feeding troughs very robust and stable.

Sku. 120018200 

RFC1 - 1 peach teat - 6L

Sku. 120018300 

BKT - 3 peach teats - 10L

Sku. 120018115 

FC5 - 5 peach teats - 30L

Sku. 120018111 

FC10 - 10 peach teats - 80L



STEP 1

CHOOSE THE CAPACITY

6 L • 10 L • 16 L • 25 L • 30 L
40 L • 66 L • 80 L

STEP 2

SELECT THE TYPE OF COMPARTMENT

- calf feeder with compartments
- calf feeder without compartments

DISCOVER OUR NEW RANGE OF CALF FEEDERS

Choose the product adapted to your needs in 2 steps.

NEW

THREADED PEACH TEAT



The Peach Teat allows no more fluid to pass through it than a cow's udder naturally would, allowing the calf to suckle more intensely than conventional technology. This stimulates the flow of saliva and improves the PH-level in the stomach and leads to better digestion. Peach Teats are manufactured from a natural rubber specially developed to meet the needs of calf rearers, ensuring that the teats feel natural and comfortable to the calf, and will eliminate mouth ulcers. Peach Teats will pull through, or screw-on, all standard calf feeders. Peach Teats can be used for tube or gravity feeding using any container with a hole size of 22mm (7/8").

Sku. 120018405 

Black - By 50

Sku. 120018404 

Pink - By 50



DUTCH BOWL 16 L



Sku. 122010 

Capacity: 16 L.
Diameter: 36 cm



DUTCH BOWL 14 L



Sku. 122011 

Diameter: 32 cm.
Capacity: 14 L



GRADUATED CALF PLASTIC BUCKET



Reinforced bottom. With handle. Liters graduation. The real capacity is at least one liter over the indicated graduation. On special request and for a minimum of 500 pieces you can choose the colour and the buckets can be personalised with a logo or with other advertising labels.

Sku. 122013 

Capacity: 14 L. Grad. 12 L

Sku. 122014 

Capacity: 16 L. Grad. 14 L

Sku. 122015 

Capacity: 16 L. Grad. 15 L

Sku. 122018 

Capacity: 19 L. Grad. 18 L



DID YOU KNOW?

Customised personalization service is available. Do not hesitate to contact us for more information

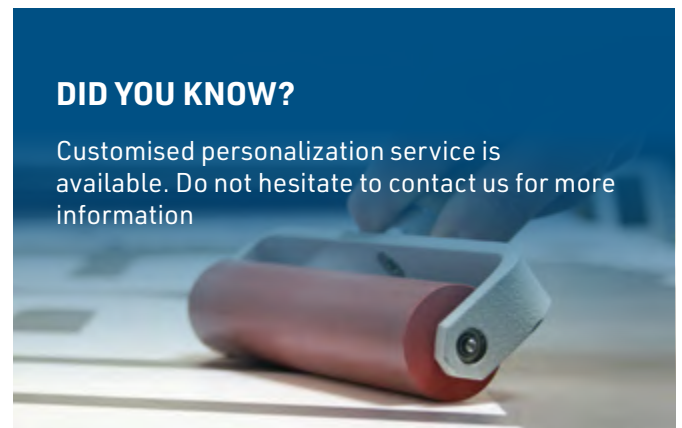

CATTLE | Feeding



CALF MUZZLE WITHOUT STRAP KAMER

White muzzle for calf without bridle. Very robust.

Sku. 120011  3 338020 010530

Grey in high density polyethylene

Sku. 120011B  3 338020 048922

White, high density polyethylene



LARGE RIGID MUZZLE KAMER

Large model muzzle for fattening calves (heavy breed). Diameter: 18 cm.

Sku. 120011002  3 338020 085637

White, high density polyethylene



WHITE CALF MUZZLE WITH STRAP KAMER

In nylon.

Sku. 120012  3 338020 034994

White



MILK THERMOMETER IN PLASTIC CAGE

Temperature range from -10°C to 120°C. Easy to clean.

Sku. 124061  3 338020 011117

Milk thermometer 



TEFLON MILK WARMER

This teflon warming milk offers a great thermal power: 2300 W. Optical display in operation. Thermostat for continuous adjustment. Constant temperature: the device turns off automatically. Do not burn the milk. Protection against projections. High stability. Easy to clean. Waterproof IPX7. Operational from 150 mm level. Helps heat the milk and maintain its temperature. Large exchange surface to facilitate heating. Waterproof device and anti-adhesive.

Sku. 120400  3 700393 921902

In teflon



ALUMINIUM MILK WARMER

To heat the milk and to keep its temperature. Large heat exchange surface to make heating easier. Tight device. Waterproof. High stability.

Sku. 120300  3 700393 921896

In aluminium



POWERHEAT HORIZONT MILK HEATER 

Heats up the milk in a minimum of time. Reduced energy consumption. Easy temperature control. Flat heating element with fast heat dissipation. Patented and innovative design enables easier cleaning of the heating element and all parts which come into contact with milk. Indicator light and audible signal when the desired temperature is reached. Automatic shut-off feature against overheating of milk. Ergonomic handles and control panel. Aluminium. Stable and waterproof (IPX7). Ideal for use in calf feeders with 8L capacity. Applicable from 150 mm immersion depth. Ergonomic working height at 90 cm. Ø: 165 mm. Low weight: 2.8 kg.

Sku. 120500	Aluminium	 4 014803 307569
--------------------	-----------	---------------------------------------------------------------------------------------------------



DIGITAL POWERHEAT MILK HEATER 



Heats up the milk in a minimum of time. Reduced energy consumption. Easily adjust temperature by the degree. Flat heating element with fast heat dissipation. Saves the last temperature. Patented and innovative design enables easier cleaning of the heating element and all parts which come into contact with milk. Indicator light and audible signal when the desired temperature is reached. Automatic shut-off feature against overheating of milk. Ergonomic handles and control panel. Stable and waterproof (IPX7). Ideal for use in calf feeders with 8L capacity. Applicable from 150 mm immersion depth. Ergonomically working height at 90 cm. Ø: 165 Reduces germ formation, protects animal health. **Digital display easily readable in bad lighting conditions.** Teflon PTFE coating.



Sku. 120600	Teflon	 4 014803 307576
--------------------	--------	-----------------------------------------------------------------------------------------------------





MILK WHISK



Sku. 124070036	Stainless steel milk whisk and handle 35 cm	 3 338020 042340 
-----------------------	---------------------------------------------	-----------------------------------------------------------------------------------------------------------------------------------------------------------------------------------------

Sku. 124070037	Stainless steel milk whisk and handle 40 cm	 3 338020 044511 
-----------------------	---------------------------------------------	-----------------------------------------------------------------------------------------------------------------------------------------------------------------------------------------

Sku. 124070042	Stainless steel whisk-short wooden handle 40 cm	 3 338020 057283 
-----------------------	-------------------------------------------------	-----------------------------------------------------------------------------------------------------------------------------------------------------------------------------------------





RUMINAL MAGNET IN PLASTIC CAGE KAMER

Very powerful magnet that prevents accidents due to the ingestion of foreign metal bodies. The cage's shape provides maximum protection and enables sharp metal pieces to stay in an optimal position. Length: 100 mm To be used with the magnet introducer Sku. 111019.

Sku. 111001  3 338020 008674

Single unit

Sku. 111001012  3 700393 910500

Box of 12 



RUMINAL MAGNETS KAMER

Very powerful magnet that prevents accidents due to the ingestion of foreign metal bodies. To be used with the magnet introducer Sku. 111019. Dimensions: 15 x 55 mm.

Sku. 111002  3 338020 008681

Box of 6 

Sku. 111003  3 338020 050000

Box of 12 



METAL INTRODUCER FOR MAGNETS KAMER

Nickel plated. Retains magnet while guide is being placed.

Sku. 111019  3 338020 008698

Length 55 cm - Inner diameter: 35 mm



MULTI BOLUS GUN KAMER

Stainless steel with aluminium handle which guarantees a good grip. Allows you to introduce 2 magnets or 2 boluses at the same time.

Sku. 111050100  3 700393 963247

Length: 46 cm
Head diameter: 25 mm
Head length: 75 mm 



BOLUS GUN KAMER

Stainless steel. It retains the magnet while placing the guide.

Sku. 111050026  3 338020 056231

Diameter: 26 mm - metal spring



ROUND CATTLE TROCER KAMER

Trocar to pierce the stomach in case of bloating. To be used when the stomach tube is not effective.

Sku. 111114  3 338020 008766

Length: 22 cm,
diameter 9 mm (for
cattle)

Sku. 111116  3 338020 008780

Length: 12 cm,
diameter 6 mm (for
sheep)

THE 4 R'S OF DEHORNING

The Right moment

As soon as possible and before 4 weeks: the younger the calf, the easier it is to handle. At this age the veins are found just under the skin.

The Right restraint

A calf that does not move makes dehorning easier for the farmer. This represents 80% of a successful dehorning.

The Right technique

The Right technique Clip first to properly locate the horn. Cauterise in 10 seconds without pressing too hard. Make a furrow of 4-5 mm. Cauterisation is not burning.

The Right pain management after dehorning

Apply a cleaning spray that cools the cauterisation. We recommend using Septiject (ref 002007). Treat against flies. Keep under careful observation for the next 48 hours. Avoid putting animals outside in wet weather.



WHY DEHORN?

For practical reasons:

- Easier access to the fence
- Save space
- Safe Handling

For safety reasons:

- Avoid accidents with the breeder
- Avoid accidents between animals

For economic reasons:

- A damaged skin decreases profitability

Different methods proposed:

- Electric or gas iron



GAS DEHORNER



Wireless, the NETHORN gas dehorner offers a run time of ± 2 hours. Thanks to its power of 350 W and its speedy rise of temperature in less than 2 minutes, this dehorner allows dehorning in 3 seconds per horn. The NETHORN dehorner has no exposed flame and has an automatic piezo ignition for starting up which can be changed without tools in a few seconds. It is a safe device in wet conditions, it can work in all positions and down to -10° C. Lightweight 770 g. 19 mm diameter nozzle supplied, **2 propene / propane / butane cartridges included**. Also works for goats (nozzle not supplied).



Sku. 103016



Supplied with 2 cartridges



GAS CARTRIDGE



Sku. 103016100



60 g propene/propane/butane



ARKOS GAS CARTRIDGE FOR CATTLE



Gas cartridge for dehorner.

Sku. 103015446



60 g Butane, propane, propene



Sku. 103401556



340 g Butane, propane



ARKOS GAS DEHORNER FOR CATTLE



The pistol Grip - new model. Lightweight: 470 g. No cable/Portable. Works with gas cartridge Sku. 103015446. Built-in Piezo ignition. Temp.: 700 °C / 1292 °F, Max temp. reached in less than 3 minutes. Safety: Lock position. Operation position. Easy to handle: Non-slip dual-material handle. Pistol shape for good grip handling. Support stand. Reversible tip internal Ø 17 and 19 mm, to best adapt to various calf breeds. Additional tip internal Ø 15 mm available on request. Self-maintenance: change the trigger/ Piezo-ignition and gas nozzle without tools.



Sku. 103015144



Supplied with 1 cartridge.





COSMOS DEHORNER

The Cosmos electric dehorner, with its Ø 16 mm tip specifically designed for cattle, is battery-operated making it very mobile and enabling the dehorning of up to 40 animals before recharging. Thanks to its mobility, animal restraint is greatly simplified and ensures total respect for animal well-being. Featuring numerous technological innovations, such as its closed circular heating wire and its built-in charge indicator, it helps operators save time and enables work in complete safety. Dehorning is made simple, with no more endless rotations. Always ready for use, it heats up and cools down almost instantly. With its unique patented system, it stops automatically when the 10-second dehorning cycle is complete. This guarantees quality dehorning for breeders, who know as soon as the operation is finished.

Sku. 103017200	On mains		
-----------------------	----------	--	--

NEW



SAROS DEHORNER

Fast, powerful, simple. Ecological innovation: less power consumed for more heating power. Lightweight and ergonomic handle: protection of the user's hand against the risk of burns.

- Fast: <5 minutes to heat up.
- Powerful: > 600 °C.
- Lightweight: 360 g handle.
- Cable length: 4 m.
- Low voltage: 24 V.
- IP68 transformer: allows working in wet areas.
- 17 mm tip.
- 2 years warranty.

Sku. 103018	On mains		
--------------------	----------	--	--



COMPLETE ELECTRIC DEHORNER 24 V UKAL

For calf dehorning. Dehorner tip goes up to 600°C. Supplied complete with a 24 V transformer. Built-in iron holder. 4 m power cord. Power 250W. Tip of 17 mm diameter included.

Sku. 103290100	24 V	
-----------------------	------	--

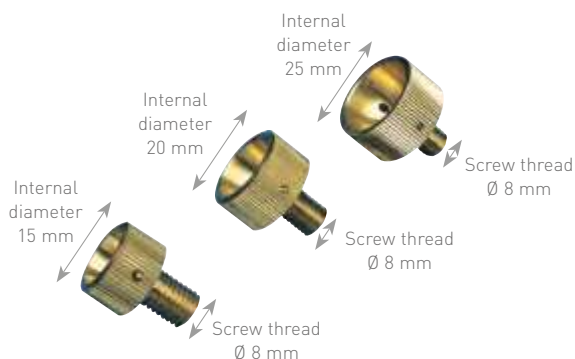

TIPS FOR DEHORNER



For dehorner sku: 103301001.

Sku. 103302015	Diameter 15 mm		
Sku. 103302020	Diameter 20 mm		
Sku. 103302025	Diameter 25 mm		

MECHANICAL BARNES DEHORNER

For cutting through the horns of calves. Metallic handle. Not for use on calves over 6 weeks.

Sku. 103307002  3 338020 053704

Diameter 13 mm
Limited stock

Sku. 103307003  3 338020 053711

Diameter 17 mm
Limited stock



RUBBER TOURNIQUET



5 mm diameter. Allows a tourniquet to be made before dehorning.

Sku. 103313010  3 275970 001563

10 m



DEHORNING PEN

For the dehorning of calves younger than 3 weeks. Corrosive substance, to use with caution. Please follow the instructions.

Sku. 103305  3 338020 031603

8 g



DEHORNING PASTE



For the dehorning of calves younger than 3 weeks. In a syringe with scale. Corrosive substance, to use with caution. Consult the instructions for use.

Sku. 103306  3 338020 042777

45 g



SWEDISH DEHORNING SAW WIRE

For the dehorning of adult cattle and embryotomy. Veterinary quality.

Sku. 103310  3 703188 019925

10 m



DEHORNING SAW KAMER WIRE

For the dehorning of adult cattle and embryotomy. This wire is extremely resistant. To be used with the dehorning saw wire handles, reference 103312.

Sku. 103311  3 338020 001695

12 m



DEHORNING SAW KAMER WIRE HANDLES

To be used with reference 103311, or with reference 103310. Antislip grooves. Supplied in pairs.

Sku. 103312  3 338020 001705

Supplied by 2



RESTRAINING RING FOR CALF



Galvanised steel. Fastens with 2 pins onto the vertical tube of a fence. The aim is to immobilise the head orientation of the calf whose snout is engaged inside the ring. Supplied with a rope.

Sku. 103315  3 275970 035106

Galvanised steel
Limited stock



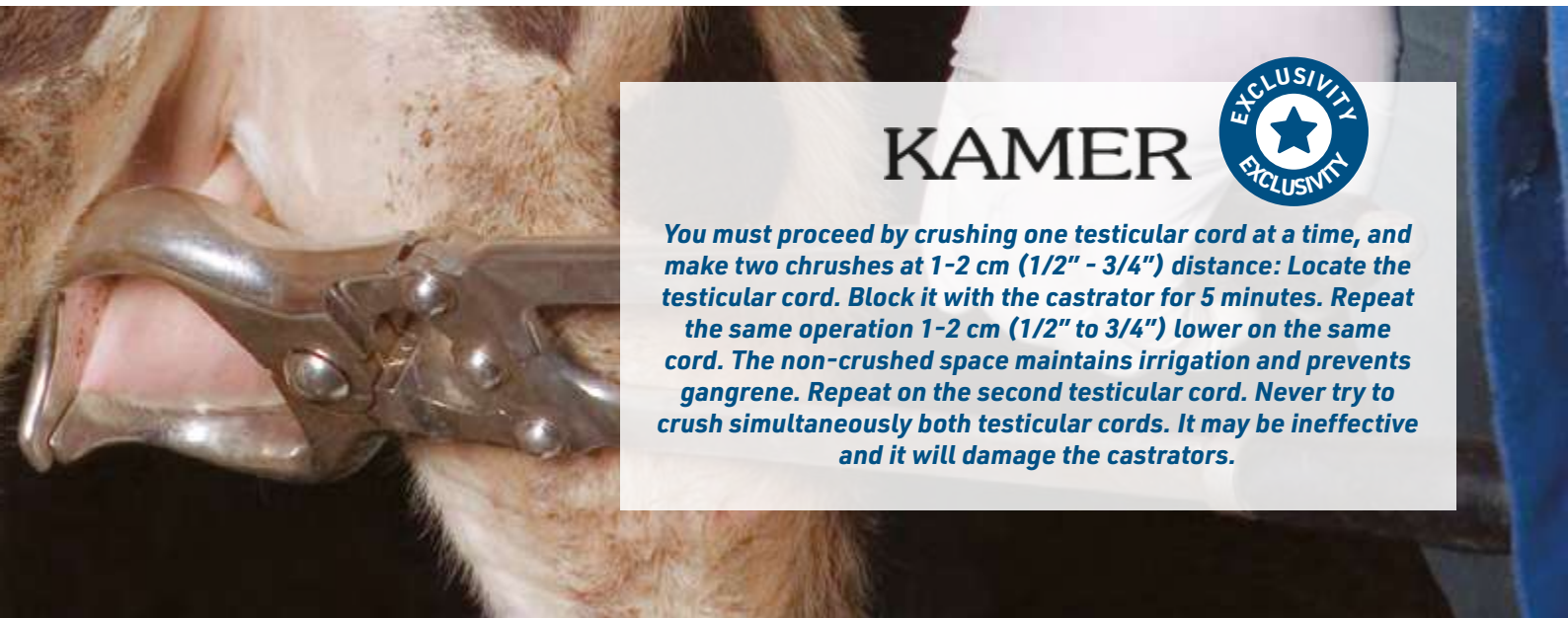

KAMER



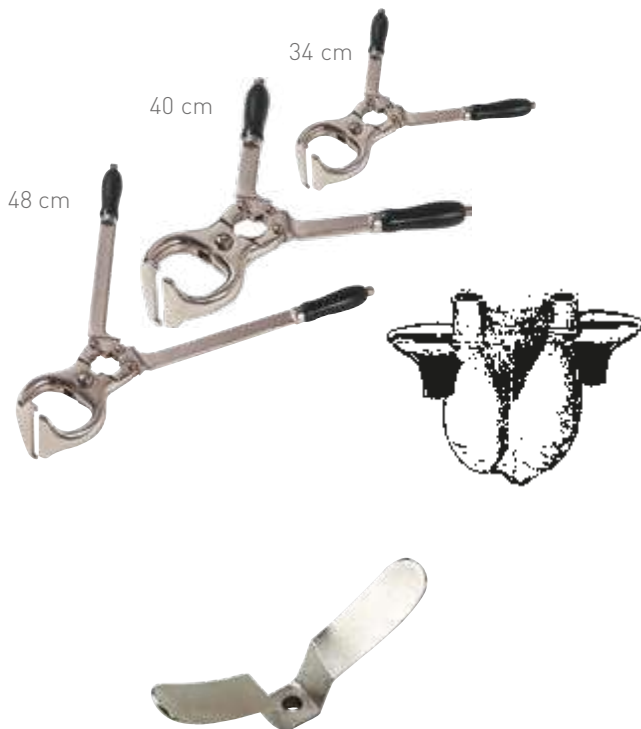

You must proceed by crushing one testicular cord at a time, and make two crushes at 1-2 cm (1/2" - 3/4") distance: Locate the testicular cord. Block it with the castrator for 5 minutes. Repeat the same operation 1-2 cm (1/2" to 3/4") lower on the same cord. The non-crushed space maintains irrigation and prevents gangrene. Repeat on the second testicular cord. Never try to crush simultaneously both testicular cords. It may be ineffective and it will damage the castrators.



BLOODLESS CASTRATOR

KAMER

Articulated with closing stop. Made of high quality forged nickel-plated steel. Supplied with a tightening key. The castration can be performed as soon as the testicles have reached their final firmness (not their final size) and within the first 6 months. The bloodless crushes the testicular cord through the scrotum skin. After use and cleaning the castrator must be stored opened.

Sku. 102223035	34 cm	
Sku. 102223040	40 cm	
Sku. 102223048	48 cm	
Sku. 9102223048CLE	Tightening key	

METAL KNEE PAD

KAMER

Suitable for all the different bloodless castrators.

Sku. 102224	Metal	
--------------------	-------	---------------------------------------------------------------------------------------

Restraining



VINK HEAD LIFT

Vink

It helps to position the head of the animal parallel to its body. In this position the animal is unable to move and it facilitates swallowing without wasting the drenching products or the mineral and vitamin supplements.

Sku. 104500	VINK head lift	
--------------------	----------------	---------------------------------------------------------------------------------------

SPIKED KAMER SWINGARM CALF WEANER

Sturdy aluminium weaner with adjustable screw and butterfly adjustment nut. For a semi permanent implementation. The most popular weaner.



Sku. 104441 

Aluminium 



CALF WEANER KAMER WITH SPRING ADJUSTMENT AND SPIKES

Aluminium calf weaner with aluminium disc and spring adjustment. Quick and easy to install and remove. With spikes.



Sku. 104439001 

Aluminium 

METAL SUCKING KAMER PREVENTOR RING

For long term use. Available in 4 sizes: Weaner size. Calf size, for calves up to 5 months. Heifer size, for calves between 5 and 24 months. Adult size, for adult calves (older than 2 years).



Sku. 104440000 

Weaner size x 5 

Sku. 104440001 

Calf size x 5 

Sku. 104440002 

Heifer size x 5 

Sku. 104440004 

Adult size x 2 

APPLICATOR FOR KAMER CALF WEANERS

Double sided: the front is used to attach the weaners. The back is to detach the weaners. Anti-slip handle.



Sku. 104440 

Calf weaner applicator

PLASTIC KAMER ADJUSTABLE CALF WEANER WITH SPIKES

Practical, efficient, economical. Weaner with screw adjustment. Avoid nasal injuries. For calves and small animals. Sold in pack of 2, 5 or 12.



Sku. 104446000 

Small model x 2 

Sku. 104446100 

Small model x 5 

Sku. 104200000 

Petit modèle x 12 

Sku. 104446001 

Medium model x 2 

Sku. 104446101 

Medium model x 5 

Sku. 104201001 

Medium model x 12 

Sku. 104446002 

Big model x 2 

Sku. 104446102 

Big model x 5 



HOW TO CHOOSE THE SIZE OF THE WEANER?

MODEL	Weaner	Calf	Heifer	Adult
AGE	Birth	up to 5 months	5 to 24 months	More than 24 months
REFERENCES	104 440 000	104 440 001	104 440 002	104 440 004
		104 446 000	104 446 001	104 446 102
		104 446 100	104 446 101	104 446 002
		104 200 000	104 201 001	104 202 002



BULL HOLDER HARMS KAMER

The two balls provide a perfect grip in the nose. **Length of 19 cm.**

Sku. 104412 

Nickel-plated forged steel - 19 cm 

Sku. 104412S 

Stainless steel 



BULL HOLDER WITHOUT CHAIN KAMER

Very robust bull holder. Supplied without chain. With two holes which allows use of a tightening rope. Length: 15cm.

Sku. 104416001 

Nickel-plated forged steel 



BULL HOLDER KAMER

For a fast animal capture. Handle length: 44 cm.

Sku. 104414 

Steel



BULL HOLDER WITH SPIRAL SPRING KAMER

Allows quick catch and release. Anti-panic system. Very robust. Length of 17 cm.

Sku. 104413 

Chrome plated forged steel 

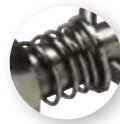

NICKEL-PLATED STEEL BULL RINGS KAMER

Self piercing bull rings. No applicator needed. Flat opening of the arches. The indicated diameters are the internal in mm. Supplied with break off screw.

Sku. 104420050	Ø 50 mm		
Sku. 104420060	Ø 60 mm		
Sku. 104420070	Ø 70 mm		
Sku. 104420080	Ø 80 mm		
Sku. 104420090	Ø 90 mm		
Sku. 104420100	Ø 100 mm		



BRASS BULL RINGS KAMER

Self piercing bull rings. No applicator needed. Flat opening of the arches. The indicated diameters are the internal ones and in mm. Supplied with break off screw.

Sku. 104421050	Ø 50 mm		
Sku. 104421060	Ø 60 mm		
Sku. 104421070	Ø 70 mm		
Sku. 104421080	Ø 80 mm		
Sku. 104421090	Ø 90 mm		
Sku. 104421100	Ø 100 mm		

CANE

KAMER

Plastic. Assorted colors.

Sk. 104402101



Ø 25 mm.



98 cm

ANTI-KICK BAR UKAL

Very robust and adjustable Anti-kick bar. Supplied in a box with rubber ends and springs. Recommended for every breeder! It is the safest, easiest, most efficient and most humane way to avoid kicks. Immobilizes both sides and keeps the animal calm during examinations or all other handlings.

Sk. 104409



Zinc - Supplied in a carton box



Sk. 104409001



Zinc. Supplied assembled - Supplied without box



NYLON HOBBLE KAMER TRIPLE ADJUSTMENT

Nylon hobble with an adjustment at the strap and another one at the legs. Very high quality.

Sk. 104411100



Blue



ANTI-KICK BAR US MODEL

KAMER

Very robust. Hand crank to adjust the opening.

Sk. 104410



Anti-kick bar



TOP RANGE STAINLESS STEEL ANTI-KICK BAR

Professional quality! 2 years warranty. New system to close quickly. Réf 9104451R (by 1) or 104448 (by 2).

Sk. 104409010



Stainless steel



ANTI-KICK BAR KIT

KAMER

For the articles 104 409 and 104 409 001..

Sk. 104449



2 springs and 2 rubber ends. Black. 6mm



Sk. 9104450E



2 rubber ends. Blue and red. For sku. 104409010



Sk. 104450



Rubber ends by unit



REPLACEMENT SPRING FOR ANTI-KICK BAR

KAMER

Sk. 104451



By unit. Diameter : 6 mm



Sk. 104451006



By 6. Diameter: 6 mm



Sk. 104451009



By 6. Diameter: 9 mm



Sk. 104448



By 2. For Sku. 104409010



MATCHING:

SPRINGS	HOBBLES
104451009	104409
104451009	104409001
9104451R (X1) ou 104448 (X2)	104409010
9104451R (X1) ou 104448 (X2)	104409020





CORDERIE PALUS

1908 - 2018

Nestling in the heart of the Corrèze countryside, Corderie Palus, the family-run rope making firm, has become a reference, over the years, in mechanically- and hand-made rope. Since 1908, the Palus artisanal long rope making firm has been renowned for its age-old know-how that combines tradition and modernity. It has managed to maintain its traditional expertise while taking on board more modern production methods, always attentive to the needs of its market. This comprehensive understanding of the entire manufacturing process guarantees a high level of quality in production and finishing made in France.

NEW

PPTEX LEADS

PPTex is a hemp-like synthetic fiber. This fiber is rot-proof and floats. PPTex is a real revolution in the world of rope: you benefit from a quality rope with a natural appearance without the usual inconveniences of hemp (odor, premature wear, etc.). Available in several sizes and diameters. Sold by 12.



Sku. 121115001V		
Length: 2,50 m. Diameter: 12 mm.		
Sku. 121116001V		
Length: 2,50 m. Diameter: 14 mm.		
Sku. 121117001V		
Length: 4 m. Diameter: 14 mm.		



NEW

PP LEADS

Polypropylene is a synthetic material that is rot-proof and anti-UV treated. Assorted colors; Available in several sizes and diameters. Sold by 12.



Sku. 121113002		
Green Diameter 12mm - 1,5m		
Sku. 121000000		
Orange Diameter 12mm - 2m		
Sku. 121116002		
Blue Diameter 16mm - 3,5m		



NEW

PP/SISAL LEADS

Available in different sizes. Sold by 12.



Sku. 121115V	Length: 2 m. Diameter: 12 mm		
Sku. 121116V	Length: 2,5 m. Diameter: 14 mm		
Sku. 121116003	Green Length: 3,5 m. Diameter: 16mm		
Sku. 121113001	Orange Length: 1,5 m. Diameter: 8mm		



NEW

SISAL LEADS

Sisal is a natural fiber from the Agave (agave sisalana) and is particularly strong. It has a very wide range of applications thanks to its good resistance and its neutral smell. Natural, ecological and biodegradable. Available in several sizes and diameters. Sold by 12.



Sku. 121116004		3 700393 926280		
Diameter 16mm - 3,5m				
Sku. 1211113		3 700393 926143		
Diameter 8mm - 1,5m				
Sku. 1211114		3 700393 926136		
Diameter 8mm - 2m				

NEW

HEMP - PP LEADS

Sold by 12.



Sku. 121112101		3 700393 926358		
Diameter 10mm - 2m				
Sku. 121112102		3 700393 926365		
Diameter 12mm - 2m				
Sku. 121112103		3 700393 926372		
Diameter 14mm - 2m				
Sku. 121112104		3 700393 926389		
Diameter 16mm - 2m				

NEW

HEMP LEADS

Hemp is a natural fiber that is glued and polished using the same traditional methods of mechanical rope making since 1908. The advantages of hemp are numerous: Very good grip, does not burn. Heat and abrasion resistant. Low elongation. 100% biodegradable. Available in several sizes and diameters. Sold by 12.



Sku. 121112	Diameter 8mm 2m		3 700393 926297		
Sku. 121112001	Diameter 10mm 2m		3 700393 926303		
Sku. 121112002	Diameter 12mm 2m		3 700393 926327		
Sku. 121112003	Diameter 14mm 2m		3 700393 926334		
Sku. 121112004	Diameter 16mm 2m		3 700393 926341		

CATTLE | Halters



NEW

PPTEX HALTERS

Available in different sizes. Supplied by 12.

Sk. 121110001V



Length: 3 m. Diameter: 12 mm



CORDERIE PALUS



NEW

PP HALTERS

Polypropylene is a synthetic material that is rot-proof and resistant to the weather. Sold by 12

Sk. 121110003



Blue white
Diameter 16mm - 3m



Sk. 121110004



Blue
Diameter 16mm - 3,5m



CORDERIE PALUS



NEW

SISAL HALTERS

Natural, ecological and biodegradable, the sisal is very resistant. Sold by 12.

Sk. 121110006



Diameter 16mm - 3,5m



CORDERIE PALUS



NEW

PP/SISAL HALTERS

Sold by 12.

Sk. 1211111V



Length: 4 m. Diameter: 14 mm



Sk. 121110005



Orange white
Length: 3,5 m.
Diameter: 16 mm



CORDERIE PALUS

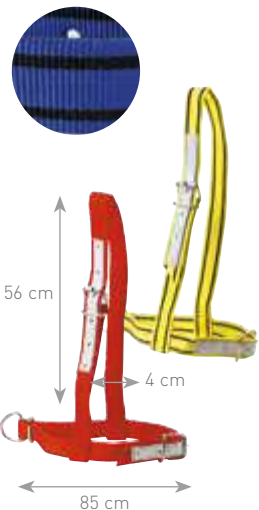

NYLON HALTER FOR COWS KAMER

Very resistant. Two reinforced adjustment loops (headpiece and noseband).

Sk. 1211107



Yellow and black



Sk. 1211107003



Red



Sk. 1211107006



Blue



COW PRESENTATION HALTER KAMER

Very robust nylon. Reinforced leather strap. Chinstrap chain and fastening ring. Supplied without lead. Height: 47,5 cm, circumference: 64 cm, width: 4 cm.

Sk. 1211103



Yellow/black



HIGH QUALITY KAMER NYLON COLLAR FOR COWS

Very robust double thickness nylon collars. Attachment ring. 125 cm x 4 cm. Thickness: 5 mm.

Sku. 121161  3 338020 076772

Yellow and black
Limited stock

Sku. 121161002  3 338020 076123

Black

Sku. 121161003  3 338020 076130

Red

Sku. 121161006  3 338020 076147

Blue

Sku. 121161008  3 338020 076789

Green
Limited stock



HIGH QUALITY KAMER NYLON COLLAR FOR BULLS

Very sturdy nylon collars due to their width and double closure. Leather reinforcement of the loop. Attachment ring. **New color: yellow and black.**

Sku. 121126010  3 700393 918810

Length 1,70 m -
Width 7 cm



SUPERIOR QUALITY NYLON COLLAR FOR COW

The top of the range. Necklace 1,30 m. Leather reinforcement at the adjustment loop. Nice finish.

Sku. 121128006C  3 700393 920394

Width 4 cm



NYLON CALF COLLAR

Leather reinforced adjustment strap. Supplied with attachment clip. **80 cm long. Width: 4 cm.** Available in different colours. Practical to distinguish groups.

Sku. 121122  3 338020 010707

Yellow and black

Sku. 121122003  3 338020 044313

Red

Sku. 121122006  3 338020 044320

Dark blue

Sku. 121122008  3 338020 044337

Green



HALTER FOR CALF

This calf halter is made of high quality nylon. Leather finish. Tightening loop.

Sku. 121139  3 700393 915444

Blue





ADDITIONAL HOOF SCRAPER

KAMER

Skü. 106625



Black painted steel
30 cm



ONE HAND HOOF CUTTER

KAMER

Skü. 106601



One hand hoof cutter



HOOF CUTTER ARTICULATED

KAMER

High transmission ratio. Powerful jaws with removable blades. For horizontal attack to the callus. Antislip handle. Total length: 41 cm (16").

Skü. 106602



41 cm



PROFESSIONAL HOOF CUTTER

KAMER

Round head with crossed jaws. Allows a side cut of the callus.

Skü. 106604



Nickel-plated steel



HOOF RASP STRAIGHT WITH HANDLE

KAMER

Double sided (fine and coarse). Plastic handle. Length: about 35 cm (13 3/4").

Skü. 106621



35 cm with handle



SPECIAL HOOF DISC

UKAL

Especially for trimming the hooves of cattle. Fits on all current types of electric hoof trimmers. Boring 22 mm. **Supplied in sets of 2.**

Skü. 106681215



Ø 115 mm

Skü. 106681227



Ø 125 mm



HOOF DISC



The granulometry avoids dirtying the disc and heating of the foot. Boring 22 mm.

Skü. 106690115



Medium grain
Ø 115 mm

Skü. 106690125



Medium grain
Ø 125 mm

Skü. 106691115



Large grain Ø 115 mm

Skü. 106691125



Large grain Ø 125 mm



DL DISC

Demotec

Lightness and robustness combining cutting efficiency and incomparable life time! No heating of the foot, no dust nor smoke. One blade set treats over 400 cattles. Tungsten blade.

Skü. 106695001



DL Disc - Ø 115 mm

Skü. 106695002



Blade and screw set

DL SOFT DISC Demotec

Less aggressive cutting due to the positioning of the blades. Blades can be used on both sides.

Sku. 106695101  3 700393 920547

DL soft disc Ø 115 mm 

Sku. 106695102  3 700393 921247

Replacement blade x 1 

Sku. 106695102SET  3 700393 921254

Replacement blade x 7 



BLACK BLUE HOOF KNIFE



Black Blue hoof knives are of high quality. The blade is tempered to allow easy sharpening and also to allowing the blade to stay sharp. Available in several models. The Black Blue knives are very strong. Ergonomic shape. Treated steel blade.

Sku. 106609BB1  3 338020 043613

Wide blade right 

Sku. 106609BB2  3 338020 043620

Wide blade left 

Sku. 106609BB3  3 338020 043637

Wide blade double 

Sku. 106609BB4  3 338020 054947

Thin blade right 

Sku. 106609BB5  3 338020 055159

Thin blade left 



BLACK BLUE RING HOOF KNIFE



BLACK BLUE ring hoof knife. Steel blade. Wooden handle. Very nice finish.

Sku. 106613BB  3 338020 052103

Ring hoof knife 



PROFESSIONAL HOOF KNIFE TOP RANGE

The professional hoof knife! Handle made of exotic wood (bubinga). High cutting quality due to its very sharp blades. The blade is 65 mm long.

Sku. 106609001  3 338020 061006

Wide right blade 

Sku. 106609002  3 338020 061013

Wide left blade 

Sku. 106609003  3 338020 061020

Wide double blade 



LA PAREUR HOOF KNIFE



Steel blade. Ergonomic wooden handle for a better grip. Very nice finish.

Sku. 106612001  3 338020 002535

Wide blade right 

Sku. 106612002  3 338020 002542

Wide blade left 

Sku. 106612003  3 338020 002559

Wide blade double 



RING HOOF KNIFE



Steel blade. Wooden handle. Good price quality ratio.

Sku. 106613  3 338020 002566

Standard ring hoof knife 





SHARPENING STONE KAMER

Essential to sharpen hoof knives, hoof shears and other knives used by shepherds. The very fine grit of the stone allows for precise sharpening of cutting tools for optimal use. 13 cm long.

Sku. 106616 

Sharpening stone



HOOF CHECKER Demotec

Shows the ideal shape of the hoof in a fast and safe way. It also allows to check the hoof angle between the base and the upper front part of the hoof. The angle should be between 45° and 50°. The angle of the tester is 50°.

Sku. 106643020 

Hoof checker



DEMOTEC EASY BLOC Demotec

Easy, quick, safe and economical. Lameness of cows can lead to significant economical losses due to a reduction of the production and weight loss in the short term. The Easy Bloc makes it possible to treat the lameness in an easy and economical way even for unexperienced users. It can be used on all kinds of hooves. **Packaging: box of 4 or 12 treatments.**

Sku. 106643004 

Box of 4 treatments

Sku. 106643010 

Box of 12 treatments

Sku. 106643011 

250 ml liquid

Sku. 106643012 

Powder 500 g



BLOCKS FOR DEMOTEC EASYBLOC Demotec

Sku. 106643013 D/2 

Right x 2

Sku. 106643013 G/2 

Left x 2

Sku. 106643013 DG2 

2 right, 2 left



DEMOTEC 90 Demotec

The DEMOTEC 90 mixture produces a very fluid (liquid) paste. After 2 to 3 minutes this mixture gets thicker and more pasty. Now it can be spread on the put it on the healthy hoof and on the wooden block. 7 to 8 minutes later the DEMOTEC 90 is completely hardened.

Sku. 106645002 

2 treatments

Sku. 106645011 

Liquid 500 ml

Sku. 106645012 

Powder 1 kg



DEMOTEC 95 Demotec

The DEMOTEC 95 mixture gives you immediately an adhesive paste ready to spread on the healthy hoof and the wooden block. **6 to 7 minutes later the mixture is completely hardened.** Box of 14 treatments.

Sku. 106644010 

14 treatments



GLUE 250 ML SEPTICARE II BOND EXPRESS XL

Our best seller glue SEPTICARE II BOND EXPRESS is now available in a new 250 ml format. Glue cartridge with 2 components. Dries in 3 seconds. Can be reworked for 15 seconds and bonds strongly in 30 seconds. Can be applied and stored from 0°C to 40°C, keeping its adhesive properties because its viscosity isn't affected by the temperatures. Nevertheless, the glue has to be at a temperature above 0°C to be used correctly. Doesn't run during the application even when applying vertically thanks to its high thixotropy: it bonds to all materials to which it is applied. Supplied by box of 12 without cannulas.

Sku. 106652001 250 ml - by 12 3 700393 963674

FIND OUR VIDEO ON YOUTUBE



SEPTICARE XL KIT

1 x 250 ml glue cartridge / 1 x gun / 10 x wooden blocks / 10 x mixing cannulas / 1 x pair of gloves / 1 x instructions paper.

Sku. 106652010 Kit 3 700393 915161



SEPTICARE II BOND EXPRESS XL CANNULAS

A cannula specifically adapted to the cartridge 250 ml of SEPTICARE BOND EXPRESS glue. Its specially designed shape allows easy extrusion of the glue as well as an optimal mix between the 2 components.

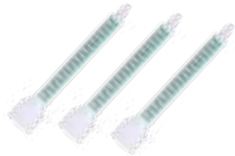

Sku. 106652002 3 700393 963254

By 10



SEPTICARE II BOND EXPRESS XL GUN

Application gun for glue SEPTICARE -II-BOND EXPRESS, size XL. Good grip, High quality.



Sku. 106652003 3 700393 962967

SEPTICARE II BOND EXPRESS XL gun



WOODEN BLOCKS

For the range DEMOTEC 90, DEMOTEC 95 and SEPTICARE BOND EXPRESS.

Sku. 106645013002 3 700393 930874

By 2

Sku. 106645013020 3 700393 930881

By 20

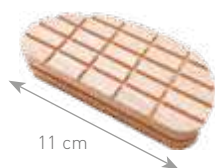

WOODEN BLOCKS XL

For the range DEMOTEC 90, DEMOTEC 95 and SEPTICARE BOND EXPRESS.

Sku. 106645014 3 700393 913310

XL 13 cm. By piece

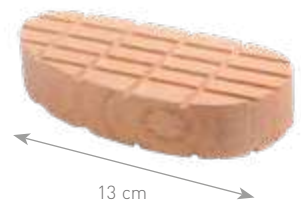



FIND OUR VIDEO ON YOUTUBE



LEG SPLINT FOR CALVES



Specifically designed for calves suffering from flexion of the pasture joints. The joint attachment allows the calf to be held and the calf to stand upright on the front legs and move freely. Leave in place for 2 to 4 weeks minimum. Durable washable nylon and durable molded ABS material. Internal padding. Velcro® safety fasteners. Treatment without plaster and bandages. Fully adjustable and reusable. Length: 22 cm.

Sku. 101125 By piece 3 700393 915789



ADHESIVE HOOF TAPE



Adhesive and very resistant tape. Ideal for bandaging hooves of cattle and horses.

Sku. 106646 3 338020 002795

25 m x 5 cm

Sku. 106646050 3 700393 940439

50 m x 5 cm



TAR BANDAGE "CERTOPLAST"



To bandage and apply protection bandages on large animals. Adhesive on both sides. Aluminium packaging. Black.

Sku. 106646100 4 022742 000632

25 m x 4,5 cm



COHESIVE FLEXIBLE BANDAGE FOR COMPRESSION



Quick and easy application. Beginning easy to find. Strong fabric, can be torn by hand. Size stretched: 10 cm x 4 m. Size unstretched: 10 cm x 2,5 m. Contains latex.

Sku. 106700 3 700393 962899

Assorted fluorescent colors - By 18

Sku. 106710 3 700393 962905

Assorted classic colors - By 18

Sku. 106710102 3 700393 922282

Black - By 18

Sku. 106710103 3 700393 922237

Red - By 18

Sku. 106710106 3 700393 922220

Blue - By 18

PREMIUM HOOFMAT

The "Premium Hoofmat" uses a 31 mm foam encased in a premium quality blue outer fabric. To optimise treatment, place the mat at the entrance to the milking platform. After milking, hang the hoofmat over a rail and hose it down. The "Premium Hoofmat" lasts over 100 000 cow passes. Contains up to 35 liters of hoofbath remedy. Top up the mat after 80 cow passes. Size: 180 x 90 cm.



Sku. 113001 9 417027 231743

180 x 90 cm





SEPTICARE CATTLE HOOF MAT

Disinfecting foam for building entrances. Perfect for the passage of animals. Large and top class model. The whole hoof treated due to the thickness of the mat. Capacity: 120-160 liters.



Sku. 113100001	180 x 90 x 10 cm		3 338020 062997
-----------------------	------------------	-----------------------------------------------------------------------------------	-----------------



NORWEGIAN PINE HOOF TAR



Hoof tar is made of natural wood tar. This natural tar protects and nourishes the hoof. Available also for hunting.

Sku. 000020	1 kg		3 338020 000029 
Sku. 000025	5 kg		3 338020 000036



BEECH HOOF TAR



Beech Tar. Protects hooves and nourishes the hoof horn. Available also for hunting. **Very good price-quality ratio.**



Sku. 000030	1 kg		3 700393 927102 
Sku. 000035	5 kg		3 700393 927119

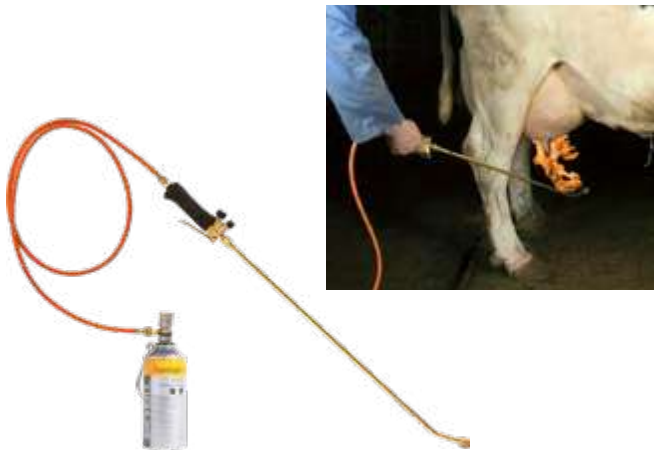



THERMIC DEPILATOR

Depilates udder hair in a secure way and without causing pain by a cold flame. It does not pose a danger to people nor animals. Appreciated for its fast action. Depilate approximately 40 to 50 animals. Supplied with: a 750ml propane gas cartridge (99%) Sku. 103400001, a 2 bar regulator, a flexible tube (20 bar) of 2 meters, a 80 cm spray nozzle, an ergonomic handle with 2 plugs and a belt clip.

Sku. 103400	Thermic depilator		
Sku. 103400001	Propane gas refill for thermic depilator. Cartridge 750 ml of propane (99%)		

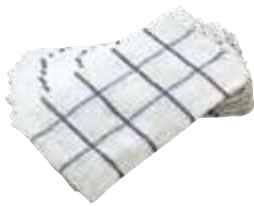

DOUBLE TISSUES



For udder cleaning. Very resistant to water washout. Do not shrink.

Sku. 112131	
Dimensions: 2 x 35 x 32 cm. By 10	



SEPTICARE UDDER TOWELS



Non-woven tissues made of 80 % viscose and 20 % polypropylene. Conform to food standards. Do not contain formaldehyde. Used to wash the cow udders. Much softer than woven tissues. They ensure an excellent cleaning and a better wiping of the teat due to the non-woven composition. Equal weight, absorb twice as much water than woven tissues. Machine washable, also in very hot water. Weight: 240 g/m².



Sku. 112131001	
Dimensions: 34 x 37 cm. Bag of 25	



FOAM DIP CUP



Produces a dense foam. Increases the contact surface and efficiency of foaming products.



Sku. 112130006	
	



TEAT DIP CUP



For soaking the teat prior to milking.

Sku. 112130	
	

MANUAL TEAT SPRAYER

Manual sprayer with rotary nozzle directional jet, facilitates spraying.

Sku. 112126



680 ml



CONICAL PLASTIC MILKING CUP

Conical strainer with tab to remove the strainer easily.

Sku. 124070047



1 L



TRANSPARENT DOSING CUP

Food safe plastic.

Sku. 124064



1 L



REACTIVE LIQUID

For the test to detect mastitis. This test gives information about the situation of the quarters before any changes in appearance are visible (inflammation of mammary tissue, lumps, water and blood, etc.). To be used with the test paddle. Consists of anionic surface-active agent and bromocresol purple.

Sku. 112134



Reactive liquid



Sku. 112136



Dosing bottle 1 ml

Limited stock

Sku. 112132



Test paddle



MASTITIS DETECTION KIT



For mastitis detection of reactive liquid. The kit contains: 1 paddle, 1 dosing bottle, 1 liter of reactive liquid, 1 teat wipe, 5 Velcro ankle straps, test report leaflet.

Sku. 112137



Complete kit



PLASTIC CATHETER

Supplied by 10.

Sku. 112204



By 10



CATHETER

Ogival catheter. Used for intra-mammary injections in the lactiferous sinus (antibiotic depletion). Used with a metal or plexi DERMAPLAST syringe. Luer lock end. By 5. Diameter: 2,5 mm.

Sku. 112210001/5



38 mm
Limited stock

Sku. 112206/5



100 mm

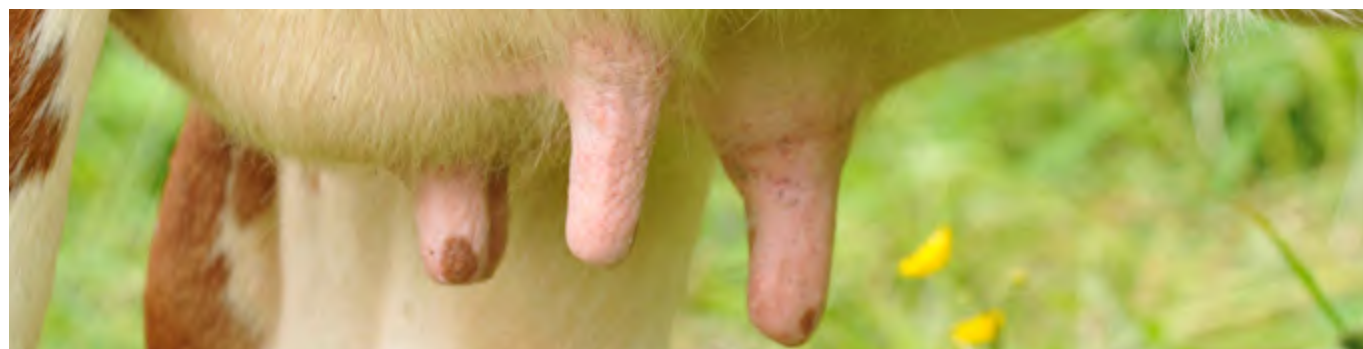



ORGANIC MILKING GREASE

The first ORGANIC milking grease! **Ideal for organic farming.** This new organic milking grease, MADE IN FRANCE, is formulated with beeswax and sunflower oil. It facilitates milking thanks to its lubricant properties. It protects and helps to heal udders by creating a protective layer. No preservatives, no disinfectants, no perfumes, no dyes. White color.

Sku. 112503	500 ml	4 012113 051547	6
-------------	--------	-----------------	---



EUTRA MILKING GREASE

Milking grease is for protecting and caring for teats and udders. Made from high-quality refined mineral oils, it facilitates milking due to its lubricating properties. Helps to protect and care for the udders by creating a protective layer and helps the healing of small wounds. **Swiss original formula.** No preservatives, no disinfectant, no fragrance substances, no colorings. Composition: Paraffinum liquidum, Petrolatum. Color: white. **Can not be used on organic farms.**

Sku. 112500002	250 ml	4 012113 015501	6
Sku. 112500005	500 ml	4 012113 016904	6
Sku. 112500010	1 L	4 012113 014900	6
Sku. 112500030	3 L	4 012113 014306	4
Sku. 112500050	5 L	4 012113 015709	2



EUTRA GEL

Gel made of Menthol and tea tree extract to protect and take care of the teats. **Cooling effect.** Effective cleaning thanks to the antiseptic properties of the plants extracts. **Can not be used on organic farms.**

Sku. 112520005	500 ml	4 012113 003362	6
----------------	--------	-----------------	---

CREMAPIS MILKING GREASE

High-quality milking fat. **Necessary for a good softening** and moisture of the teat tissue. Aseptic. Color: yellow.

Sku. 112160005	500 ml	3 338020 029457	6
Sku. 112160010	1 L	3 338020 029464	12
Sku. 112160030	3 L	3 338020 029471	4

TRAYBAIN MILKING GREASE

Facilitates milking and maintains healthy and soft teats. **Protects from cold and draughts.** Color: green.

Sku. 112170001	1 L	3 275970 006490	12
Sku. 112170005	5 L	3 275970 006513	2



TEAT PLUG FOR MILKING LINERS

Closes a milking liner when a teat is not working or if a teat does not exist.

Sku. 112390002	By 2		
-----------------------	------	-----------------------------------------------------------------------------------	-----------------------------------------------------------------------------------

NON-WOVEN DISK FILTERS BOSCH AND SCHÖRLE



New generation non-woven milk filters welded through a process without glue or chemicals. **Öko -Tex Standard 100 and can be used on organic farms.** They don't affect the quality of milk and allow a smooth and rapid flow. Very resistant, they are not weakened by the holes formed by the stitching unlike sewn filters. Box of 200.









Sku. 124075170	170 mm		
Sku. 124075180	180 mm		
Sku. 124075200	200 mm		
Sku. 124075230	230 mm		



NON-WOVEN FILTERS BOSCH AND SCHÖRLE



New generation non-woven milk filters welded through a process without glue or chemicals. **Öko -Tex Standard 100 and can be used on organic farms.** They don't affect the quality of milk and allow a smooth and rapid flow. Very resistant, they are not weakened by the stitching unlike sewn filters. **No thread = no hole = better filtration.** Box of 250.

Sku. 124064250	250 x 125 mm		
Sku. 124064570	570 x 44 mm		
Sku. 124065250	250 x 58 mm		
Sku. 124065320	320 x 58 mm		
Sku. 124065465	465 x 58 mm		
Sku. 124065500	500 x 58 mm		
Sku. 124065530	530 x 58 mm		
Sku. 124065620	620 x 58 mm		
Sku. 124068455	455 x 80 mm		
Sku. 124068600	600 x 80 mm		
Sku. 124068620	620 x 80 mm		
Sku. 124068640	640 x 80 mm		
Sku. 124068800	800 x 80 mm		
Sku. 124069610	610 x 95 mm		



FIND OUR VIDEO ON YOUTUBE



DID YOU KNOW?

Milk filters are used for safety and health reasons. They are put on the milking machines to filter milk from dirt and bacteria. The filter size must be chosen according to the milking machine.



OIL FOR MILKING MACHINE **UKAL**

The special oil for milking machine is designed for the lubrication of vacuum milking machine pumps. Used in summer and winter. Suitable for all types of vacuum pumps. **Viscosity: to 40°C: 46 cst, to 100°C: 7,6 cst.**

Sku. 112600005



5 L



CONTROL COVER WASHER

For control cover (Sku. 112601).

Sku. 112601001



CONTROL COVER WITHOUT SEAL

Without seal.

Sku. 112601



Control cover without seal
Limited stock



QUARTER MILKER

For the milking of a teat which is sick or under treatment. Avoids mixing with healthy milk.

Sku. 112129



8 L

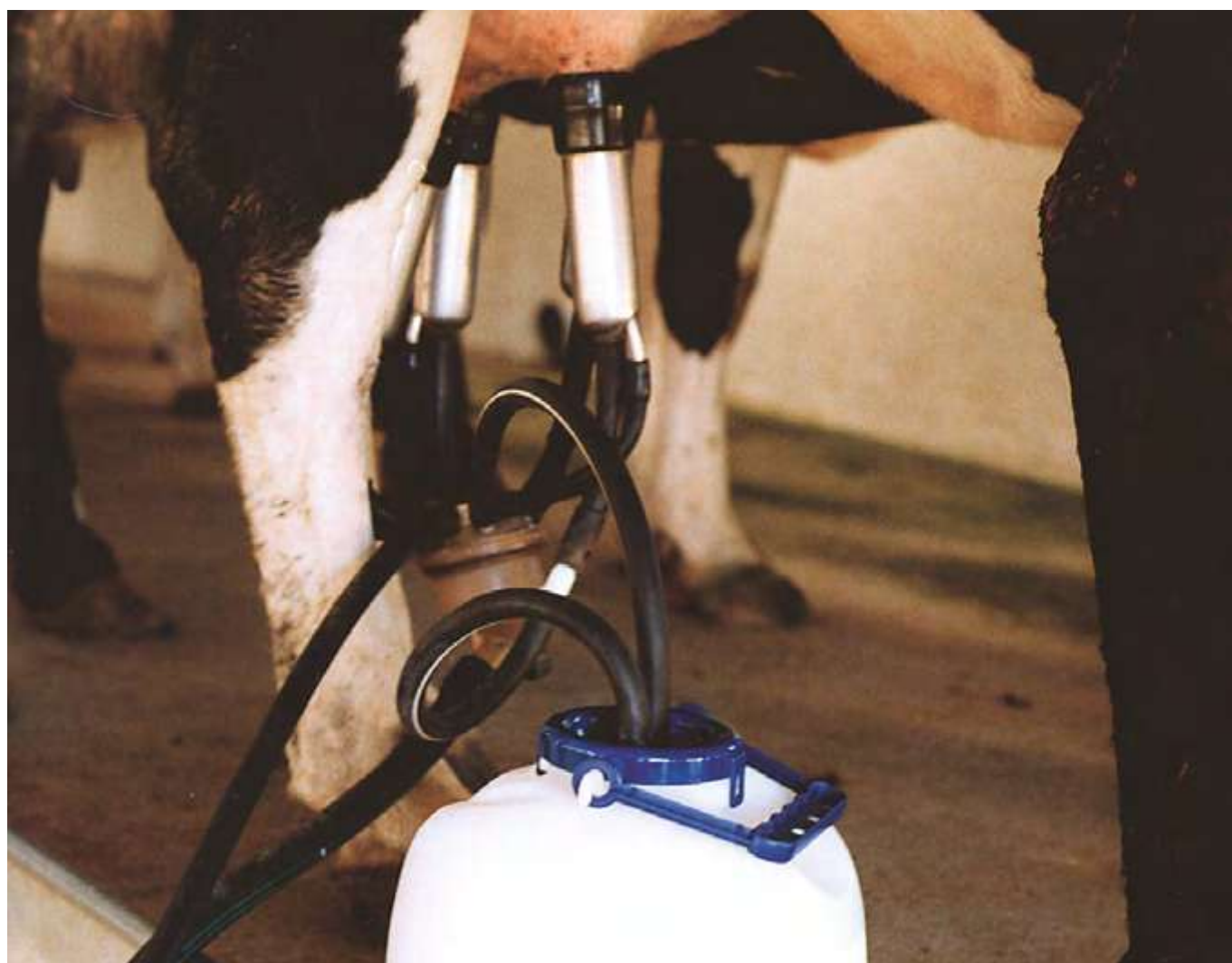

Milk cans

STAINLESS STEEL MILKING PAIL **UKAL**

Robust and very durable. Very easy to clean. Without lid. Food grade quality.

Sku. 124008030



Height: 49 cm.
Ø base 33,5 cm.
Ø opening 18 cm



STAINLESS STEEL MILK CAN FOR TRANSPORT **UKAL**

Really robust, made in stainless steel. Food grade quality.

Sku. 124009030



30 L. H 50 cm.
Ø 33,5 cm



MILK CAN WITH ALUMINIUM LID **UKAL**

Made of aluminum, robust and very resistant to impacts. Does not pick up odors and easy to clean. Food grade quality.

Sku. 124100010



With handle 10 L.
H 32 cm. Ø 25 cm

Sku. 124100020



Without handle 10 L.
H 32 cm. Ø 25 cm



ALUMINIUM MILK SAMPLER DIPPER

Can measure and collect the milk.

Sku. 124063010



1 L



MILK FUNNEL & ALUMINIUM GRILLS

Sold with cones set, lower disc, strainer and circlips. Food grade quality. Fits on milking pots for optimal filtration.

Sku. 124020030



Ø 300 mm



ALUMINIUM BUCKETS

Aluminum bucket with spout. Capacity : 12 L.

Sku. 120003012



12 L





SPECIAL DAIRY BRUSH

Can be boiled. Food grade nylon bristles. Very robust. Bristles length: 40 mm. Weight: 270 g.

Sku. 124001



L 195 x W 60 x H 60 mm



SCRUBBING BRUSH

Can be boiled, robust. Food grade nylon bristles. Weight: 260 g.

Sku. 124002



L 195 x W 60 x H 60 mm



MILK TANK BRUSH

Food grade nylon bristles. Can be boiled. To use with a handle. Supplied without handle. Very robust. Bristles length: 40 mm. Weight: 280 g.

Sku. 124003



L 90 x W 55 x H 115 mm



CLEANING BRUSH

Food grade. Supplied without handle. Width: 26 cm.

Sku. 124004



26 cm



BRUSH WITH SHORT HANDLE

Bristles length: 40 mm. Weight: 220 g. Food grade.

Sku. 124006



L 260 x W 172 x H 55 mm



BRUSH WITH LONG HANDLE

Bristles length: 40 mm. Weight: 220 g. Food grade.

Sku. 124007



L 400 x W 45 x H 55 mm



HANDLES

Polypropylene handle.

Sku. 124000P



Length: 1,20 m



ROTARY BRUSH

Rotary brush used to clean milking liners. Can be used with all brands. Food grade nylon bristles.

Sku. 124010



Food grade nylon bristles

4 BRUSHES KIT

Sku. 124011



4 brushes, a bulk tank outlet brush, a separator brush and an angle brush



STRAIGHT BRUSHES

Straight brush used to clean milking tubes. Food safe nylon bristles.

Sku. 124010001



L 40 cm - Ø 10 mm



Sku. 124010002



L 100 cm - Ø 15 mm



Curry Comb

METAL CATTLE CURRY COMB KAMER

Nickel-plated comb with metal handle. Flat body with coarse teeth, mane and tail comb.

Sku. 123302



Nickel-plated comb with handle
21 x 17,5 cm



SQUARE CURRY COMB WITH COMB KAMER

Coarse teeth, flat body, equipped with a mane and tail comb, nickel-plated metal. Plastic handle.

Sku. 123303



22 x 24 cm



SQUARE CURRY COMB FLAT BODY KAMER

Coarse teeth, flat body, made of nickel-plated metal. Plastic handle. 7 rows.

Sku. 123305



14,5 x 22,5 cm



CURRY COMB

Round metallic curry comb (also called "american") serrated differently on each side for more or less sensitive horses. Stays dirt free.

Sku. 130E700029



14 x 27 cm



CATTLE | Brushes



NATURAL FIBER BRUSH KAMER

Sku. 123307



220 X 55 X 700 mm - Big model



WOODEN CARDER KAMER

Size: 120 x 170 mm.

Sku. 151010



120 x 170 mm - Large claw



PNEUMATIC CARDER KAMER

Size: 120 x 170 mm.

Sku. 151030

120 x 170 mm - Fine claw



COW BRUSH KAMER

Zinc coated metal. Very strong spring. Supplied with 2 brushes with plastic back and nylon bristles. **The cow brushes are essential elements of hygiene and comfort in a cattle's life in a shed.** Avoids injuries caused by rubbing against concrete and metal parts of the shed. Spring Sku: 9123327.

Sku. 123315

Cow brush in zinc coated metal



SPARE BRUSH KAMER

For shed brushes Sku. 123315 and 123325. Plastic back. Nylon bristles. Size: 50 x 10 x 10 cm.

Sku. 123316

Spare brush for shed brushes



VINK COW BRUSH Vink

Special nylon brush for livestock. Horizontal moveable brush. Solid spring suspension. Spring Sku: 9123325.

Sku. 123325

VINK nylon cow brush



ROUND BRASS BELL

KAMER

Clapper available on request. Please consult the list in the price list and on the website.











Sku. 121803100	Ø 100 mm. Loop: 50 mm. Height: 70 mm		
Sku. 121803110	Ø 110 mm. Loop: 50 mm. Height: 77 mm		
Sku. 121803120	Ø 120 mm. Loop: 70 mm. Height: 84 mm		
Sku. 121803130	Ø 130 mm. Loop: 70 mm. Height: 91 mm		
Sku. 121803140	Ø 140 mm. Loop: 70 mm. Height: 98 mm		
Sku. 121803150	Ø 150 mm. Loop: 70 mm. Height: 105 mm		
Sku. 121803180	Ø 180 mm. Loop: 82 mm. Height: 126 mm		



BLACK BLUE STEEL BELL

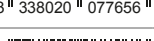

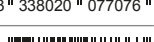
Steel bell for sheep and goats. Nice tone. Clapper available on request. (réf. 1218069064 et 1218069088). Please consult the list in the price list and on the website.

Sku. 121806064	Ø 64 mm. Loop: 50 mm. Height: 64 mm		
Sku. 121806088	Ø 88 mm. Loop: 50 mm. Height: 115 mm Limited stock		
Sku. 121806104	Ø 104 mm. Loop: 75 mm. Height: 104 mm		
Sku. 121806120	Ø 120 mm. Loop: 82 mm. Height: 120 mm		
Sku. 121806144	Ø 114 mm. Loop: 82 mm. Height: 144 mm		



BROWN LEATHER COLLARS

KAMER

Soft chrome-tanned leather. Ideal for bells. Different sizes available: 6 or 8 cm wide. Length: 120 or 135 cm.

Sku. 121162126	120 x 6 cm		
Sku. 121162128	120 x 8 cm		
Sku. 121162136	135 x 6 cm		
Sku. 121162138	135 x 8 cm		



PUNCH PLIERS

To adjust your leather goods.

Sku. 130E700423	By piece		
------------------------	----------	-------------------------------------------------------------------------------------	-------------------------------------------------------------------------------------



Heiniger

XPLORE THE POWER

XPLORERPRO
≡2-SPEED≡



SWISS MADE  PRECISION

PATENTED



TENSION
INDICATOR



2-speed



Li-Ion



-120 min

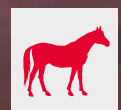

ERGO
NOMIC



light



UKKAL

— SHEEPS

50	Lambing
51	Feeding
53	Clipping
54	Dehorning
54	Castration
55	Restraining
57	Hoof care
58	Bells

SHEEPS | Lambing



EWESPOON WITH TIES

KAMER

The ewespoon is a simple and economical way to control gestation problems. It is used for ewes and goats to keep the uterus in place in case of a prolapse. His model is made of plastic with two ties and is heat resistant.

Sku. 101112

By 4



USE OF THE EWESPOON

There are several reasons of uterus prolapse by ewe:

- mineral deficiency,
- traumatic (caught up in a rush during feed distribution),
- obstetrical (early contractions).

For ewes, the uterus prolapse is before the lambing. The ewespoon, must be placed after cleaning and placing the genital tract in its original place.

Use always disposable gloves, and obstetrical gel. To keep the ewespoon in place, attach it to the wool, or attach a tie of the ewespoon to the ewe straps. The ewespoon must be released while lambing. Pay careful attention to ewes with a ewespoon to avoid any problems with lambing and delivery.



SHEEP EWESPOON IN NYLON

KAMER

Helps to keep the uterus in place in case of an prolapse. Heat-proof plastic.

Sku. 101110002



By unit



PROLAPSE NEEDLES

KAMER

Elles permettent le maintien de l'appareil utérin après un prolapsus. Nickelées. Livrées par 5.

Sku. 101114



Without eyelet.
Size : 8 cm



Sku. 101114A



With eyelet.
Size : 8 cm



Tétiblu

LAMB FEEDER 11 L

Multi-bottle twin compartment placed on rack or board. Comes complete with teats and the corresponding valves. With the new flared shape of each of the two compartments, the flow of milk is total. No more waste or loss of milk. In addition, it is very robust due to the reinforcement of the central part. High Density Polyethylene (HDPE) grade. The original! Comes with 6 natural rubber lamb teats Sku. 120004 and 6 valves Sku. 120022.

Sku. 120008006



11 L



DID YOU KNOW?

Latex is made from the sap of rubber trees and offers an easier sucking thanks to its softness and flexibility.



Tétiblué

COMPLETE SET FOR LAMB FEEDER

It consists of 6 natural rubber teats for lamb Sku. 120004 and 6 valves. For multi-bottle feeder Sku. 120008006.

Sku. 120008007



Complete set for lamb feeder



Tétiblué

VALVE FOR LAMB TEATS

For lamb teat Sku. 120004.

Sku. 120022



In aluminium
By 6



Tétiblué

LATEX LAMB TEAT

With hole.

Sku. 120004006



By 6

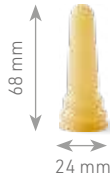

Tétiblué

LATEX TEAT FOR BOTTLE

Pierced. Really supple.

Sku. 120019042



By 6

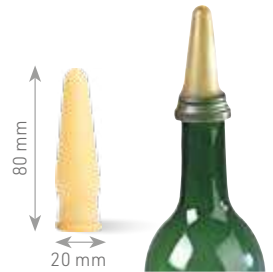

COMPLETE LAMB FEEDER, 6 RUBBER TEATS 12 L

Nursing trough for lambs without handle. Ideal for 6 lambs. Plastic with steel hook. Supplied with 6 natural rubber teats and aluminum valve. Dimensions: 38,1 x 30,5 x 25,4 cm. Capacity : 12 liters.

Sku. 120008002

12 L



Tétiblué

NATURAL RUBBER LAMB TEAT FOR LAMB FEEDER

Very flexible natural rubber teats. X shaped hole. For lamb feeder bucket Sku. 120008006.

Sku. 120004050



By 50



Sku. 120004



By 6

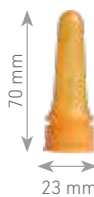

Tétiblué

NATURAL RUBBER LAMB TEAT FOR BOTTLE

Pierced. Supple.

Sku. 120019



By 6





NEW



LAMB FEEDER BOTTLE

38 mm extra wide neck for easy filling, with a strong plastic collar to ensure secure fixing of the teat. Extra tough to prolong life and calibrated for accurate feeding, sterilize by boiling. Delivered with one teat.

Sku. 120008120



500 ml



COLOSTRUM FEEDER FOR LAMB

Suitable for feeding the correct amount of colostrum to large lambs without refilling; positive pressure can be applied to save time. Length: 33 cm.

Sku. 120008130



250 ml



TEAT FOR LAMB BOTTLE

Specially designed teat with unique moulded in vacuum release valve. Bulbous teat end encourages more rapid acceptance by lambs. Hollow cone tip allows flow of milk to be regulated.



Sku. 120008220



By 6



TRUSTI FEEDER FOR LAMB

A specially designed Trusti Tuber ANTAHI rehydrator for lambs with a specific mouthpiece and a flexible and transparent tube. Simple to use with one hand, very practical and easy to hold. Ergonomic and stable shape allowing a good flow by gravity and not under pressure, safer and easy to control. Capacity: 240 ml.

Sku. 120008200



240 ml



COLOSTRUM BAGS FOR LAMBS 1 L



Colostrum bags help to develop and strengthen lambs' immunity from birth. They come with a large opening to facilitate filling and cleaning and can hold **1 litre** to meet the feeding needs of young lambs and kids. The bags can be deep-frozen flat to preserve the nutritional qualities of colostrum over time. They are suitable for pasteurisation and can be quickly defrosted. Their comfortable handles make them very user-friendly for the farmer. The bag's transparency is also a plus point. It allows the user to see at a glance how much is left in the bag. Colostrum bags are **designed to be reused** (durability and easy cleaning). Please note that the number of times a bag can be reused will depend on how well it has been cared for.

Sku. 120008210

By 10



Sku. 120008250

By 50



Sku. 120008300

Teats for colostrum bags
By 6



HAND SHEEP CLIPPERS

KAMER

Sku. 100337



1-hand sheep clippers



Sku. 100337101



Comb blade set
Limited stock



NICKEL-PLATED SHEEP SHEARS



Very nice finish in nickel-plated steel. This nickle plated straight blade sheep shears is great for small sheep. Easy clipping. Single bow. High quality cutting. Exists in two sizes.

Sku. 100339002



Size: 29 cm
Blade's length: 14,5 cm



DOUBLE BOW SHEEP SHEARS

KAMER

Double bow, red painted handle sheep shears comes with straight blades. The handle and blades are one piece of forged steel. Used for parts which are difficult to reach or for shearing the whole sheep. Available in two sizes.

Sku. 100339



Size: 34 cm.
Blade's length: 16,5 cm



Sku. 100339001



Size: 29 cm.
Blade's length: 14,5 cm

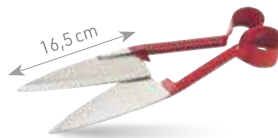

BLACK BLUE SHEEP SHEARS RIGHT-HANDED



The black blue sheep shears are incontestably the finest shears in our range. Made from hardened and tempered steel, they are equipped with rubber stoppers to smoothen the shearing. Strong and long lasting.

Sku. 100350



Size: 29 cm
Blade's length: 16 cm



Sku. 100351



Size: 34 cm
Blade's length: 16 cm



CURVED BLADE SHEARS

KAMER

Sku. 100339003



Size: 29 cm
Blade's length: 14,5 cm



Sku. 100339005



Size: 24 cm
Blade's length: 9 cm



PROFESSIONAL KAMER YELLOW SHEEP SHEARS

Professional yellow sheep shears. One piece handle and blades / double bow **for intensive use**. Its manufacturing quality and 16,5 cm blades allow you to shear your sheep easily.

Sku. 100360



Size: 34 cm
Blade's length: 16,5 cm

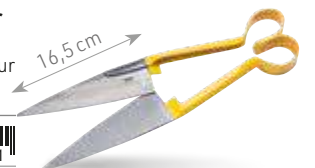

SHEEPS | Dehorning and castration

Dehorning



COSMOS ELECTRIC DEHORNER FOR GOATS

The Cosmos electric dehorner with its Ø 14 mm tip specifically designed for goats, is mains-operated for extreme ease-of-use. Always ready for use, it heats up and cools down almost instantly. With its unique patented system, it stops automatically when the 10-second dehorning cycle is complete. This guarantees quality dehorning for breeders, who know as soon as the operation is finished. You no longer need to worry about the power supply as its 6-metre mains cable offers superb handling for high-quality dehorning. With numerous technological innovations, such as the ceramic head with integrated circular heating wire and a built-in power supply indicator, it helps operators save time. Weight: 560 g. Heating temperature: 700 °C.

Sku. 103017300

On mains



3 189640 001275

THE 4 R'S OF DEHORNING

The Right moment

As soon as possible and before 4 weeks: the younger they are, the more they are easy to handle. At this age the veins come just under the skin.

The Right restraints

A lamb that does not move restraining dehorning easier for the farmer. This represents 80% of a successful dehorning.

The Right technic

Shear prior to properly locate the horn. Cauterize in 10 seconds without pressing too hard (10 seconds max). Make a furrow of 4-5 mm. Cauterization, not a burn.

The Right pain management after dehorning

Apply a cleaning spray that cools cauterization. Treat against flies. Keep under careful observation the following 48 hours. Avoid putting animals outside in wet weather.



Castration



23 cm



30 cm



BLOODLESS CASTRATOR

KAMER

Articulated with closing stop. Made of high quality nickel-plated. The castration can be performed as soon as the testicles have reached their final firmness (not their final size). The bloodless castrator allows the testicular cord to be crushed through the scrotum skin. You must proceed by crushing one testicular cord at a time, and make two crushes at 1-2 cm (1/2" - 3/4") apart.

- Locate the testicular cord.
- Block it with the castrator for 5 minutes.
- Repeat the same operation 1-2 cm (1/2" to 3/4") lower on the same cord. The noncrushed space maintains irrigation and prevents gangrene.
- Repeat on second testicular cord.
- Never try to crush simultaneously both testicular cords. It may be ineffective and it will damage the castrators. After using and cleaning the castrator must be stored opened.

Sku. 102223023

23 cm



3 338020 001446

Sku. 102223030

30 cm



3 338020 057818

Sku.

9102223048CLE

Tightening key



3 700393 939280

METAL KNEE PAD KAMER

Suitable for all bloodless castrators.

Sku. 102224



3 338020 001491

By unit



STEEL EMASCULATOR

KAMER

Makes a clean cut and stops the blood by crushing the blood vessels.

Sku. 102209



3 338020 001330

Straight 19,5 cm



RUBBER RING APPLICATOR

KAMER



With a wide opening for an easy application and with a high gear ratio. Made of nickelplated forged steel. Very resistant. High-quality model! Can also be used for tailing.

Sku. 102201 

Nickel-plated forged steel 



CLASSIC ORANGE RUBBER RINGS

KAMER

Rubber used for tail docking and castration. Premium quality, rolled rubber. Please check the safety instructions before use. Keep away from children. Professional use only.

Sku. 102202100 

By 100 

Sku. 102202500 

By 500 



SHEPHERD LEG CROOK

KAMER

With a fixed and a movable handle.

Sku. 104452 

0,95 m 



STANDARD RUBBER RINGS APPLICATOR

Economical model.

Sku. 102200 

Steel 



ELASTRATOR RUBBER RINGS



Quality rubber rings. For castration and tailing of lambs, goats and calves. The younger the animal the better. Elastrator rings are designed to be used on calves no older than two weeks, and lambs and goats no older than three weeks. Use after this period is not recommended.

Sku. 102150100 

Box of 100 

Sku. 102150500 

Box of 500 



NICKEL PLATED STEEL CATCH HOOK

KAMER

Made of nickel-plated steel. Use with a 28 mm diameter handle.

Sku. 104452100 

Ø 28 mm 



ALUMINUM CATCH HOOK

KAMER



Made of aluminium. Use with a 21 mm diameter handle.

Sku. 104452200



Internal Ø 21 mm



SHEPHERD STOVEL

KAMER



Made of nickel-plated steel. Use with a 20 mm diameter handle.

Sku. 104452500



Internal Ø 20 mm

Limited stock

RAM APRON

KAMER

Prevents unwanted mating, Fastening strap made of nylon. Clip closing. Adjustable strap length. Width 60 cm and height 30 cm. Depending on availability.

Sku. 104452700

L 60 cm x H 30 cm



HEAD GATE FOR SHEEP

KAMER

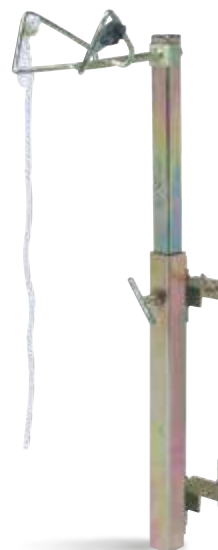

Ideal for preparations for shows, shearing, styling, tattooing, identification, hoof care, replacing of a prolapse, difficult lambing or dosing. Robust and solid design. To fix on barriers, fences, grills or any other rails. Height adjustable by the slidable headpiece. Supplied with lanyard. Locking closure. Very practical to carry. For all sizes of animals. **It only weighs 7,5kg!** Structure of zinc-plated steel, ensures a long life time. **Works also for calves.**

Sku. 106901



Minimum height 36 cm

SHEEP HOOF SHEARS

KAMER

Large 6 cm replaceable blades. Lightweight and resistant. Thick aluminium handle for a better grip. The hoof shears of professionals!

Sku. 106607 

Not serrated 6 cm 

Sku. 106607001 

Serrated 6 cm 



SHEEP HOOF SHEARS

KAMER

Nickel-plated steel. Short or long blades, serrated or non serrated. Very resistant. Very nice finish.

Sku. 106605 

Not serrated 6 cm 

Sku. 106605001 

Serrated 6 cm 

Sku. 106606 

Not serrated 8 cm 



PREMIUM SHEEP HOOF SHEARS

KAMER

Non-serrated high-carbon steel blades - heat treated to cleanly cut even hard hooves. Does not rust, padded handle protects hand and joints. Easy action, one-handed locking device. Quality product, practical and lightweight shears for daily use.

Sku. 106605002 

Not serrated 



FELCO HOOF SHEARS



They improve considerably the working conditions for the breeder. Increased efficiency due to the easy handling and exceptional cutting performance. Light forged metal handle. Lightweight and resistant. Xylan coated blades for better hygiene. Closing with rubber shock absorber. 2 models available : with a fixed handle and with a rotating handle (for an intensive use and saves effort).

Sku. 106608001 

Rotating handle 

Sku. 106608002 

Fixed handle 



SHEEP HOOF KNIFE



Steel blade. Ergonomic wooden handle for a better grip. Very nice finish.

Sku. 106612 

Double blade 



BLACK BLUE HOOF KNIFE



High quality. One piece blade and handle. Black handle. Ergonomic shape. Treated steel blades. Available in different versions.

Sku. 106609BB4 

Right fine blade 

Sku. 106609BB5 

Left fine blade 



SHEEPS | Foot care and bells

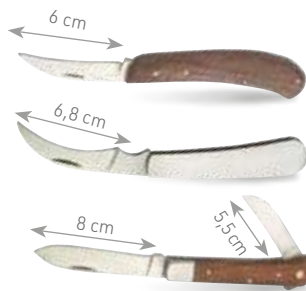

SHEPHERD'S KNIFE		KAMER	
Sku. 128300	1 x 6 cm blade		
Sku. 128301	1 x 6,8 cm blade		
Sku. 128302	2 blades 8 cm and 5,5 cm		

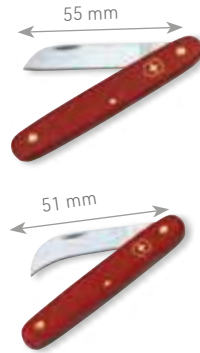

VICTORINOX SHEPHERD'S KNIFE		VICTORINOX	
Original Victorinox Folding Knife. Length: 100 mm. Swiss quality.			
Sku. 128303	Straight blade 55 mm		
Sku. 128304	Curved blade 51 mm		



WRAPPING SET

The essential kit for wrapping the legs of lambs and goats. Contains 2 strips of plaster 2 m x 10 cm and a jersey sock 2 m x 3 cm.

Sku. 106608100	Complete kit		
-----------------------	--------------	--	--

Bells

ROUND CAST BRASS BELL

KAMER

Alpine type bell for sheep. Clapper available on request.

Sku. 121800050	N°5 Ø 50 mm. Loop: 30 mm. Height: 35 mm		
Sku. 121800057	N°6 Ø 57 mm. Loop: 30 mm. Height: 40 mm		
Sku. 121800067	N°7 Ø 67 mm. Loop: 35 mm. Height: 50 mm		
Sku. 121800075	N°8 Ø 75 mm. Loop: 45 mm. Height: 55 mm		
Sku. 121800090	N°9 Ø 90 mm. Loop: 45 mm. Height: 65 mm		



ROUND STEEL BELL

KAMER

Bronze color. Traditional alpine and Jurassic bells for sheep and goats, type redon. Clapper available on request.

Sku. 121801045	Ø 45 mm. Loop: 30 mm. Height: 60 mm		
Sku. 121801055	Ø 55 mm. Loop: 38 mm. Height: 75 mm		
Sku. 121801060	Ø 60 mm. Loop: 42 mm. Height: 90 mm		
Sku. 121801080	Ø 75 mm. Loop: 42 mm. Height: 110 mm		







For spare parts, please contact us.

STRAIGHT STEEL BELL

KAMER

Bronze color.



Sku. 121802055	Ø 55 mm. Loop: 35 mm. Height: 60 mm	3 338020 077007	
Sku. 121802065	Ø 65 mm. Loop: 43 mm. Height: 75 mm	3 338020 077014	
Sku. 121802075	Ø 75 mm. Loop: 50 mm. Height: 85 mm	3 338020 077021	
Sku. 121802090	Ø 90 mm. Loop: 60 mm. Height: 100 mm	3 338020 077038	



BLACK BLUE STEEL BELL



Steel bell for sheep and goats. Nice tone. Clapper available on request. (ref. 1218069064 and 1218069088). Please consult the list in the price list and on the website.

Sku. 121806064	Ø 64 mm. Loop: 50 mm. Height: 64 mm	3 338020 077649	
Sku. 121806088	Ø 88 mm. Loop: 50 mm. Height: 115 mm	3 338020 077434	



COPPER PLATED STEEL BELL KAMER

3 types of traditional bell for cattle and goats.

Sku. 121807020		
80 x 95 mm		
Sku. 121807001		
50 x 50 mm. 9 mm loop		

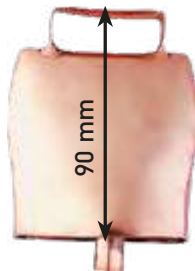

LEATHER COLLAR FOR SHEEP KAMER

Buffalo leather.

Sku. 1211727055		
27 mm x 55 cm		
Sku. 1211747055		
47 mm x 55 cm		



Heiniger

Sheep shearing
machine

XPERT

2-SPEED

NEW!
2-SPEED

**Fast &
ergonomic**

Developed and manufactured
in Switzerland

High speed with
2500/2800
double strokes

Extremely
quiet

Lightweight,
small and ergonomically
shaped for comfort

Robust and
durable

Controlled
airflow

quality  swiss made

Int.Pat.Nr DM/078 110 EU
Pat.Nr. 138501 CH
Pat.Nr. 340969 AUS
Pat.Pending US/CN

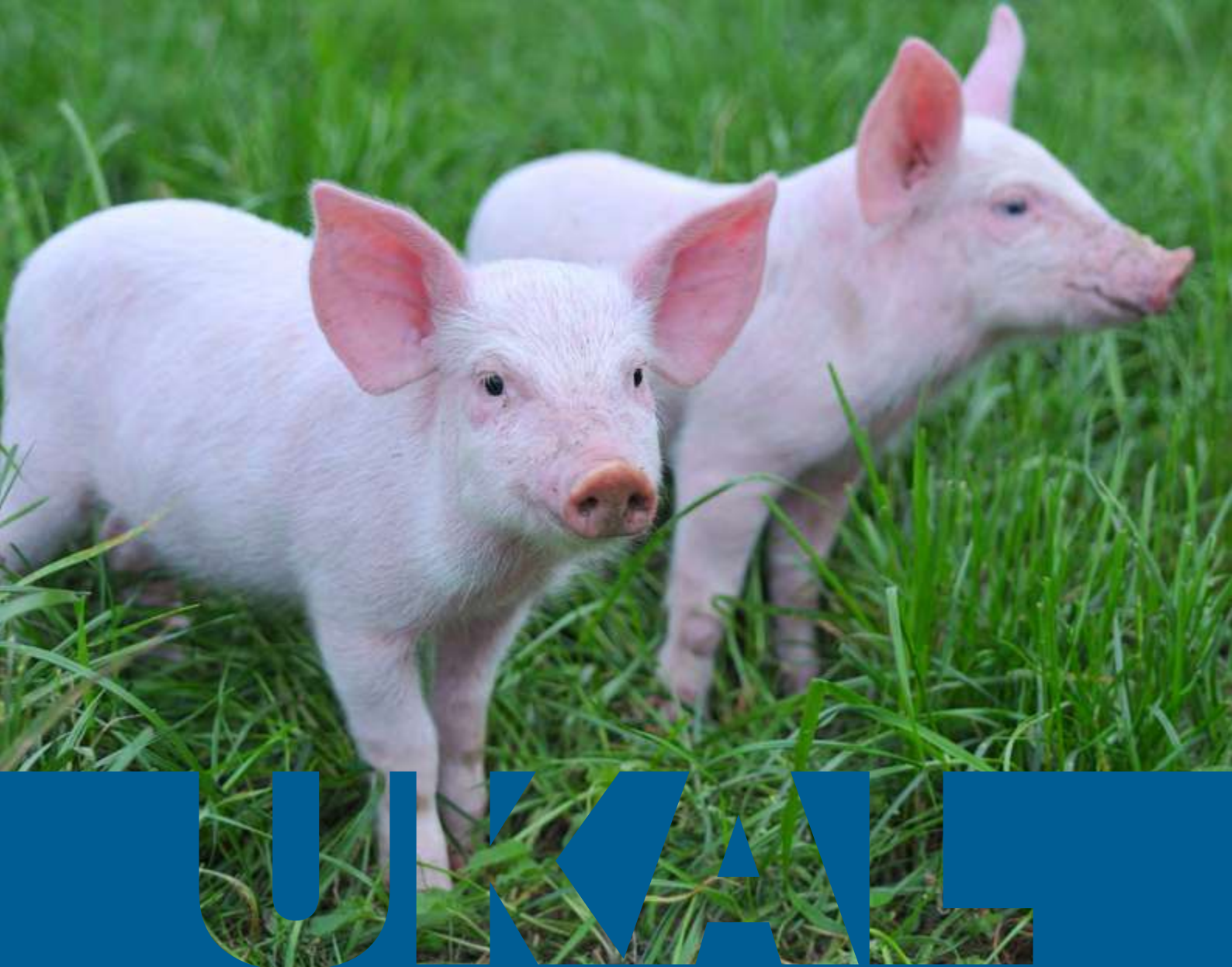

UKAL

—
PIGS

- 62 Feeding and scalpel
- 63 Tooth cutting and restraining
- 63 Restraining

Feeding



FISH OIL WITH 50% COD LIVER OIL

UKAL

High quality nutritional supplement naturally rich in omega 3, in AD3E vitamins and essential fatty acid. Blends with traditional foods. Use daily or as a cure. Contains 50% cod liver oil, as well as fish oil. Only for animal consumption. Our new formula contains winterized oil, much more digestible. Wintering consists of the cold filtration of oils.

Sku. 000100	1 L	3 338020 000067			12
Sku. 000500	5 L	3 338020 000081			4



Scalpel



SCALPEL HANDLE KAMER NO. 4

Accepts all scalpel blades for fixed handle no. 4. Sterilizable.

Sku. 102204

Fixed handle
Delivered by unit.

Sku. 102205

Foldable Handle.
Delivered by unit.



SCALPEL BLADE KAMER NO. 22

Delivered in pack of 10.

Sku. 102206022

Box of 10



SCALPEL BLADES

KAMER

Blade individually packed. Delivered in pack of 100.

Sku. 102206120	n°20 / box of 100 Limited stock	3 338020 059232		
Sku. 102206121	n°21 / box of 100 Limited stock	3 338020 059249		
Sku. 102206122	n°22 / box of 100	3 338020 061235		
Sku. 102206123	n°23 / box of 100 Limited stock	3 338020 051267		
Sku. 102206124	n°24 / box of 100 Limited stock	3 338020 051274		

Tooth cutting

NICKEL-PLATED TOOTH CUTTING NIPPER KAMER

Nickel plated, length: 13 cm.

Sku. 105520



Cut length: 16 mm



STAINLESS STEEL TOOTH CUTTING NIPPER KAMER

Length: 13 cm. Stainless steel.

Sku. 105521



Cut length: 20 mm



SUPER PRO TOOTH CUTTING NIPPER KAMER

Slip-resistant handle. The shape of the blades prevents gum injuries.

Sku. 105523



Stainless steel.
Cut length: 16 mm



Restraining

PIG HOLDER, SELF-LOCKING KAMER

Heavy and very robust model. Self-locking loop. Reinforced loop and end. Cable easy to replace. 60 cm.

Sku. 105509001



60 cm. Nickel-plated metal and steel cable

Sku. 105509002



Pig catcher 60 cm, self locking



MINI ALUMINIUM PIG CATCHER KAMER

Mini catcher. Molded aluminium handle. Safety device on restraining cable.

Sku. 105509005



Aluminium



PIG HOLDER KAMER

Restrains pigs by the snout. Both hands are needed to maintain the tension. Reinforced loop. Made of nickel-plated metal. With steel cable. No self-locking.

Sku. 105509



60 cm. Nickel-plated.



PIG CATCHER WITH SLIP KNOT KAMER

Steel cable. Large rubber handle that ensures a good grip. Not very cumbersome. 80 cm.

Sku. 105510



Nickel-plated





PIG STAPLES APPLICATOR

Aluminium screw to adjust the opening. Used to place the wire pig staples no. 3 (Sku. 105 504 003) and no. 4 (Sku. 105504004).

Sku. 105507	
Aluminium	



TRIANGULAR PIG STAPLES

Stop pigs from foraging on the ground. To be used with applicator Sku. 105507. Two sizes available. Delivered in pack of 100.

Sku. 105504003	
3 cm / box of 100	
Sku. 105504004	
4 cm / box of 100	



PIG RING APPLICATOR

For rings Sku. 105502. Nickel-plated steel. High quality. Robust.

Sku. 105503	
Nickel-plated steel	



NICKEL-PLATED STEEL PIG NOSE RINGS

High quality. Keeps a perfect circular shape after application. Self-locking. To be used with applicator 105503. Pack of 10.

Sku. 105502	
Box of 10	



HOT SHOT POWERMITE

Pocket powermite. Compact and robust. Works with 2 9V 5LF22 batteries (not included). Works even on wet animals.

Sku. 104405010	
Works with 2 9V 5LF22 batteries (not included)	



HOT SHOT PLUS POWERMITE

Effective electric shock! Cuts off after 2 seconds in accordance with the latest animal protection law. Long life expectancy. Can also be operated with an extension handle. 5000 V max. voltage.

Sku. 104405020	
Hot Shot Plus powermite	



GUIDE PADDLE

With rattling noise. For guiding animals in an animal-friendly way. PVC handle and rubber arm.

Sku. 105511	
110 cm	



SCRATCHNALL™ PAD



Offers wellness for all kind of animals! Safe and effective way of self-scratching. No danger to skin, face and eyes. Durable quality. Flexible nubs for comfortable scratching. Unique interlocking design. Adjust the grooming surface as large as needed. Mounted individually or in groups flat on walls or around a corner. Can be folded on a 90° angle on corners.

Sku. 123340002	
12,7 x 15,24 cm Limited stock	



UKALAGRI

— POULTRY

- 66 Incubation
- 69 Chicken coop
- 72 Feeders & drinkers
- 75 Care
- 83 Rings
- 84 Well-plucked
- 85 Rabbits



BOROTTO designs and produces technologically advanced, high performance incubators, operating in compliance with advanced quality standards UNI EN ISO 9001 certified. By taking completely original ideas and developing them into revolutionary technical applications, three of which have been patented, Borotto has made its mark in the field of artificial incubation.



Incubators



LUMIA 8 INCUBATOR AUTOMATIC DIGITAL



- In Heat-Resistant ABS with Biomaster.
- Lumia 8: A small, technologically advanced, high performance machine. Its elegant design with "smart" technology makes this machine smart and easy to use and one of the best in its class.
- Lumia 8 stems from a desire to make the miracle of life available to all. It includes the highest professional incubation technology aimed at those with a limited number of eggs. The same technology that Borotto uses in larger models that can reach a higher level of accuracy and reliability.
- Lumia 8 is designed and built to better meet farmyard poultry and valuable species breeding requirements. Thanks to the use of innovative materials and a functional and ergonomic design, Lumia 8 is an indispensable instrument that is easy to use, both for the professional breeder and for all new breeding enthusiasts who want to try breeding farmyard animals for the first time, with expectations of a good result.

Dimensions : 39 x 22 x 20 cm.

Sku. 530300008 8 eggs



LUMIA 16 INCUBATOR PATENTED AUTOMATIC DIGITAL



- In Heat-Resistant ABS with Biomaster.
- Lumia 16: A small, technologically advanced, high performance machine. Its elegant design with "smart" technology makes this machine smart and easy to use and one of the best in its class.
- Lumia 16 stems from a desire to make the miracle of life available to all. It includes the highest professional incubation technology aimed at those with a limited number of eggs. The same technology that Borotto uses in larger models that can reach a higher level of accuracy and reliability.
- Lumia 16 is designed and built to better meet farmyard poultry and valuable species breeding requirements. Thanks to the use of innovative materials and a functional and ergonomic design, Lumia 16 is an indispensable instrument that is easy to use, both for the professional breeder and for all new breeding enthusiasts who want to try breeding farmyard animals for the first time, with expectations of a good result.

Dimensions : 39 x 34 x 24 cm.

Sku. 530300016 16 eggs





Automatic turning.



Digital temperature.



Outdoor filling.

DIGITAL SEMI AUTOMATIC INCUBATOR



Our digital incubators are designed to be simple and straightforward to use, at the same time offering innovative technical solutions and high reliability. Digital display. It is possible to set the temperature from 32°C to 40°C with 0.1°C steps by pressing the (+) and (-) buttons (Programme Mode). Inspection windows allow to follow each phase of the incubation. Mouths to fill the water trays from outside, avoiding the opening of the incubator and the dispersion of heat and humidity.

Sku. 530200024	24 eggs	
Sku. 530200049	49 eggs	



DIGITAL AUTOMATIC INCUBATOR



The incubator is ideal for chicken eggs, pheasant, guinea fowl, quail, partridges, duck, mallard, goose, turkey, peacock, bartavelle, pigeon, hake, exotic birds and birds of prey. Digital Display temperature control with decimal point. Range Temperature changeable from a Min of 30°C to a Max of 40°C. Precise electronic thermostat $\pm 0.1^\circ\text{C}$. Ventilation with turbine, diameter 100mm. **One complete inclination every 2 hours. 220V.**

Sku. 530300024	24 eggs	
Sku. 530300049	49 eggs	
Sku. 530200	Motor for digital incubator automatic	





Incubator accessories



EGG CANDLER

This product is intended for the control of egg incubation. Using this egg spotter, you can check for the presence of cracks on the shell and the fertilisation of the egg and the stage of development of the embryo. Works on area 220V. maximum power: 15W. Delivered with two rubber inserts.



Sku. 530002010	
	3 700393 919640
	



SPARE THERMOMETER

Display of 25°C to 45°C.

Sku. 5300050	
	3 338020 013173
Angled	
Sku. 530050001	
	3 338020 087822
Straight	

Heating plates



EGG SPOTTERS ADVICES

Apart from the presence of cracks and the stage of development of the embryo, you can also inspect the proportion of air inside the egg. Indeed, this percentage allows you to determine and adjust the level of humidity of your incubator, which is essential to the success of a good breeding. The diagram on the left shows the correspondence between the proportion of air and the number of days of incubation. Adjust your humidity as a function of the air proportion observed.

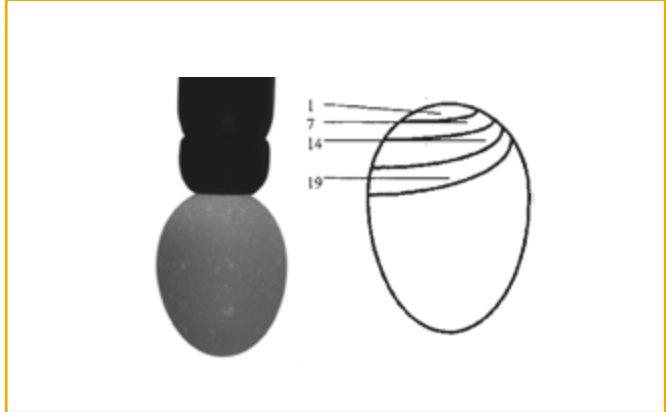

HEATING PLATE FOR CHICKS

Provides a very soft as if under distributed warmth on the surface. The chicks will nest there as under the wing of their mother. Adjustable height to adapt to the growth of the chicks and splash-proof. Shell in very resilient plastic with insulation, washable and supporting water splashes. Cover available upon request.

Sku. 530005025	25 x 25 cm 15-20 poussins		1	
Sku. 530005030	30x30cm 20-25 chicks		2	
Sku. 530005040	40x40cm 30-35 chicks Limited stock		3	
Sku. 530005050	40x50cm 40-45 chicks		4	
Sku. 530005060	40x60cm 50-55 chicks Limited stock		5	

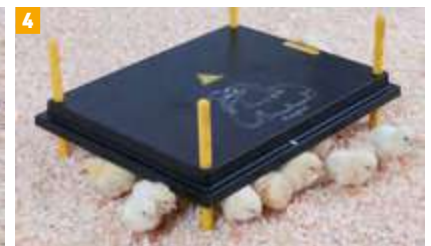
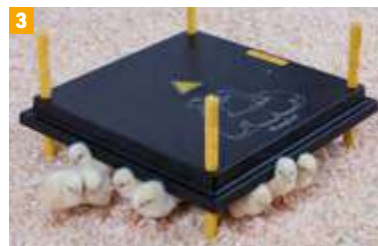

Cage

CHICKS AND QUAIL REARING CAGE

Ultra-practical between the incubator and the poultry house. Feeding trough and drinking trough for 150 chicks. After the incubator, the small paradise for the chicks before joining the poultry house! The opening is on the top. This breeder contains a retrieval tray for droppings. Very easy to maintain. Feel free to add a heating lamp to keep your chicks warm. To assemble yourself.

Sku. 531100 150 chicks 



→ Please, have a look p. 89 to discover our light bulbs offer.



Poultry houses

GALITY POLLY BERGAME POULTRY HOUSE

The Gality Polly Bergame henhouse is a superb fully equipped henhouse! Warm thanks to the insulating role of the HPL, it is strong and designed to last. It has 2 wooden perches high up for sleeping. The secure entrance allows you to sleep in peace! The wooden decoration gives a familiar and aesthetic appearance. Supplied as a kit for quick assembly. Capacity: 2 to 4 hens dimensions on the ground: 70 x 85cm. Overall dimensions: 80 x 80 x 130cm



Sku. 595426 

Poultry house for 2 to 4 hens

GALITY POLLY VENISE POULTRY HOUSE

The Gality Polly Venise henhouse is a particularly innovative 4 to 6 chicken henhouse. Maximum comfort for your chickens with unequalled ease of assembly. Strong, durable, beautiful and spacious, it takes full advantage of the material HPL. Supplied in kit form, it can be set up like child's play in a few minutes. Capacity: 4 to 6 hens. Floor dimensions 80 x 105 cm overall 105 x 96 x 157 cm.



Sku. 595427 

Poultry house for 4 to 6 hens

ISLAND PREMIUM POULTRY HOUSE

Beautiful, well equipped the nesting box are covered with ventilation hatch with shutter. BeautifulVery well equipped henhouse in wood. 1 vent hatch with damper, nesting box with 2 compartments with outside access, 2 perches. The access hatch of large size (32x43cm) with ramp allows the accommodation of large hens. A door (dim. 36x46cm) located on the back allows easy cleaning of the living area. Delivered run as a kit, easy to assemble. Fits perfectly with the universal pathway, providing a secure space for your hens. Dimensions on the ground: 71x95cm - overall: 130x115x80cm. New model with a galvanized sheet metal roof, one of the two doors is sliding. This poultry house is made of treated wood. Not exportable outside Europe. (ISPM15 standard). We won't be responsible for any delivery problems if you order this product.



Sku. 595400 

Poultry house for 6 to 8 hens

COLORADO POULTRY HOUSE

Capacity : 6-8 hens

Dimensions :
On the ground : 223 x 84 cm
Overall : 268 x 195 x 96 cm

Material : Treated wood. The roof and the nest are covered with a tarpaulin.

Equipment : An air vent with shutter, 2 compartment nest with outside access, perches, a large access hatch with ramp, a door in the back makes it easy to clean the interior.

This poultry house is made of treated wood. Not exportable outside Europe. (ISPM15 standard). We won't be responsible for any delivery problems if you order this product.



Sku. 595402 

Poultry house for 6 to 8 hens

OSLO POULTRY HOUSE



Large perfectly Comfortable external poultry house. It's suitable for dwarf or large breed hens. Comfort and practical. The nesting box is accessible from the outside for the collection of eggs without panicking the hens. Delivered as a kit. Capacity: 8 to 12 hens. Dimensions on the ground: 259 x 143cm - overall: 278 x 195 x 180 cm. In treated wood. Roof with asphalted canvas. Soldered mesh grilling 25 x 25mm.

This poultry house is made of treated wood. Not exportable outside Europe. (ISPM15 standard). We won't be responsible for any delivery problems if you order this product.

Sk. 595403



Poultry house for 8 to 12 hens



OTTAWA POULTRY HOUSE

We have designed this poultry house for your best nesters: comfortable internal nesting box and perches facing each other, it is equipped with 2 grilled Ventilation openings. The nesting box and the run part are accessible from the top. It adapts to the universal pathway (optional) while its sliding hatch can be equipped with an electronic gatekeeper (optional). Delivered as a kit, very easy to assemble. Capacity: 5 to 7 hens. Dimensions on the ground: 70x120cm - overall: 88x140x116cm high. In stained wood. The roofing in galvanised metal provides both sealing and durability.

This poultry house is made of treated wood. Not exportable outside Europe. (ISPM15 standard). We won't be responsible for any delivery problems if you order this product.

Sk. 595422



Poultry house for 5 to 7 hens

CALGARY POULTRY HOUSE



Large, deep, fully equipped, this poultry house will amaze you with you by its dimensions. Unique on the market, we wanted it to be functional and aesthetic. One side is dedicated to the nesting boxes while the other is equipped with perches as trelliswork. Ideal for laying hens, it is well ventilated and equipped with an exit runs each facade with sliding hatch. It can be equipped with 1 or 2 universal pathways. Delivered as a kit, very easy to assemble. Capacity: 8 to 12 hens. Dimensions on the ground: 120 x 140cm - overall: 158 x 140 x 116 cm high. In stained wood, it has a galvanised metal roofing.

This poultry house is made of treated wood. Not exportable outside Europe. (ISPM15 standard). We won't be responsible for any delivery problems if you order this product.

Sk. 595423



Poultry house for 8 to 12 hens



NORWAY POULTRY HOUSE

Very large poultry house aviary designed both to provide maximum comfort to the hens and their owner! For the hens: Spacious shelter equipped with a nesting box and perches, large aviary protected from draughts, access to the garden by the exit hatch, adjustable ventilation internal tilting nesting box that makes egg collection easier and safer. Easy cleaning. Particular new concept of internal nesting box for tilting that facilitates and secures the egg collection. Delivered as a kit and easy assembly. Capacity: 10 to 12 hens. Dimensions of the ground: 181 x 233 cm. Overall: 190 x 245 x 190 cm high. In stained wood, roof with asphalted canvas.

This poultry house is made of treated wood. Not exportable outside Europe. (ISPM15 standard). We won't be responsible for any delivery problems if you order this product.

Sk. 595424



Poultry house for 8 to 12 hens

UNIVERSAL RUN FOR POULTRY HOUSE



This run is designed to fit on many poultry houses. A small ledge ensures the run of hens going from under the henhouse. A run at the end of pathway to let out the poultry while the top opens 2/3 for easy access. A removable panel to fully close the pathway, thus transforming it into a completely practical run. Dimensions 150 x 93 x 67 cm. Frame treated wood supports a mesh grilling 13 x 13 mm.

This poultry house is made of treated wood. Not exportable outside Europe. (ISPM15 standard). We won't be responsible for any delivery problems if you order this product.

Sk. 595425



Coop

FOLDABLE COOP

A cage without a bottom, easy to move, so your pets always have access to the grass. Outdoor cage for rabbit, guinea-pig, poultry. Dimensions: 1 x 1 x 0.50 m (wire 2 mm). It allows the grazing of small farm animals.

Sku. 595115 Pliable hen run
Wire 2mm 3 338020 082636

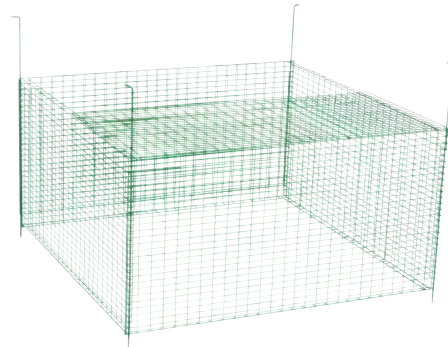

Nests

NESTING BOXES

Fully galvanised. Bottom in inclined mesh allowing an easy collection of always clean eggs and protects against cannibalism.

Sku. 400010 Single nesting
nest, 33 x45
x 35 cm 3 700393 911958

Sku. 400011 Double nesting
nest, 63 x 45
x 35 cm 3 700393 912016
Limited stock



PHEASANT EGGS GREEN PAINTED WOOD

Lure in wood, green. Allows fixing of the place of egg laying.

Sku. 520005 3 338020 051618

By 2
Limited stock



PAINTED WOOD HEN EGGS

Lure in painted wood. Allows fixing of the place of egg laying.

Sku. 520001003 3 700393 933905

By 3



NATURAL WOOD HEN EGGS

Lure in natural wood. Allows fixing of the place of egg laying.

Sku. 520002003 3 700393 933912

By 3
Limited stock



CERAMIC HEN EGGS

Lure in ceramic. Allows fixing of the place of egg laying.

Sku. 520010003 3 700393 933929

By 3



POULTRY | Colorful range

Plastic drinkers



DRINKER WITH HANDLES

Drinker with ankle. Delivered with feet.

Sku. 510100005	5 L		
		3 700393 962318	10
Sku. 510100015	15 L		
		3 700393 962325	4

Plastic feeders



FEEDER WITH PLASTIC FEET

Adjustable with Greenical nylon rod. Delivered with feet.

Sku. 505100009		
	3 700393 962349	5
9 L		
Sku. 505100020		
	3 700393 962394	5
20 L		



COLORFUL PLASTIC FEEDER

In yellow, orange or red plastic!! Practical and easy to clean. 18 kg.

Sku. 505018019	
	3 700393 964114
10 to 13 hens	
Limited stock	



COMPACTA FEEDER BIG CAPACITY

The feeder is made of durable plastic. The yellow body is a unique piece that supports itself without the need for a central stem or sleepers. It is very easy to assemble. The amount of food in the dish can be adjusted through one of three holes provided. The feeder is provided with lid and can be placed on the ground or suspended. The anti-waste gate and the suspension ring are integrated in the body. Design facilitates stacking, optimizing spaces. **The feeder is delivered without feet.** Feet available Sku. 505100P.

Sku. 509100008		
	3 700393 915673	10
8 kg		
Sku. 509100015		
	3 700393 962332	10
15 kg		



CHICK FEEDER 50CM GREEN

In plastic! Practical and easy to clean.

Sku. 505050008	
	3 700393 964282
15 chicks	



HEN FEEDER 75 CM PINK

In coloured plastic! Practical and easy to clean.

Sku. 508075021	
	3 700393 962424
20 hens	

Plastic drinkers

TRANSPARENT BLUE DRINKING TROUGH



In blue plastic. Practical and easy to clean.

Sku. 510100006



5 L with handle



"ECO" DRINKING TROUGH FOR CHICKENS



Highly resistant antibacterial plastic drinkers, ideal for chickens. Easy refill thanks to the cap.

Sku. 510200006



8 L - 8 hens



POULTRY GRAVITY DRINKERS WITH TWISTED CAP OR BAYONET CLOSURE



Made of high quality plastic, very UV resistant. Professional design. Easy to clean.

Sku. 510103001



1 L - with twisted cap

Sku. 510103041



4 L - with bayonet closure and handle

Sku. 510103008



8 L - with bayonet closure and handle



MULTIFUNCTION DRINKER «MAXI CUP»



The drinker is easily attached to all types of tanks up to 180cm water depth. This tank fills half automatically. It is easy to install and use and is very easy to maintain. Adapts to several varieties of animals (chickens, birds...). Indoor or outdoor use.

Sku. 510103005



0,5 L



POULTRY DRINKER



Made of high quality plastic, very UV resistant. Professional design. Easy to clean.

Sku. 510103006

0,6 L



Sku. 510103013

1,3 L



Sku. 510103040

4 L - with handle



Sku. 510103065

6,5 L - with handle



Sku. 510103012

12 L - with handle

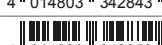

Plastic feeders



BLUE TRANSPARENT FEEDER

Easy to use and easy to clean. Can be hung.

Sku. 505004006	4 hens		
-----------------------	--------	-------------------------------------------------------------------------------------	-------------------------------------------------------------------------------------



POULTRY FEEDER «MOUNTAIN»

The «Mountain» feeders are very resistant thanks to their high quality plastic, and they are easy to clean. Thanks to its automatic feeding system, your birds will always receive fresh feed. Its conical shape is particularly suitable for this use. This range can be used suspended or laid directly on the floor. Possibility to adjust the dosage thanks to its height. UV protection for a better resistance. Feeder entirely made of plastic and very UV resistant. Easy maintenance. Can be used suspended or placed on the ground, adjustable by height adjustment.

Sku. 505300015	1,5 kg Without lid		
Sku. 505300003	3 kg With lid		
Sku. 505300005	5 kg With lid		
Sku. 505300008	8 kg With lid		



Drinkers

METAL BUCKET CONSTANT LEVEL DRINKING TROUGH 12L

Metal bucket constant level drinking trough.

Sku. 501112



3 700393 919602

12 L



TRIPOD GALVANISED DRINKER 22 L

Tank drinking trough in galvanised steel on steel tripod. The height of the drinking trough cup allows poultry to have permanently available good quality water.

Sku. 510002030



3 338020 083015

22 L



Feeders

FEEDER ANTI-PESTS

The automatic opening of the hopper is done by simple pressure when poultry goes to the feeding trough. Avoids pests being introduced into the food. Delivered with lid.

Sku. 400001



3 700393 911927

15 L - 10 hens

Sku. 400002



3 700393 911934

30 L - 20 hens



FEEDING TROUGH WITH HOPPER

For breeding with anti - waste edge and rain canopy protection placed on or hanging from the rear.

Sku. 400003



3 700393 911972

10 L - 8 hens

Sku. 400004



3 700393 911965

18 L - 13 hens

Sku. 400005



3 700393 911989

25 L - 17 hens



FEEDER WITH ROOF AND ROTATING ROLL

Roll of 60cm, capacity 4,2 L. Completely galvanised. The turning roller prevents pigeons from roosting.

Sku. 400006



3 700393 911941

4,2 L - 15 hens





ENAMELLED HEN FEEDER WITH HOPPER

Control of flow by rack and pinion. Ideal product for feeding outdoors poultry and small game without the risk of waste and pollution of food. In galvanized sheet.

Sku. 500009	5 L - 6 hens	3 338020 012848
Sku. 500010	25 L - 17 hens	3 338020 012855
Sku. 500011	40 L - 25 hens	3 338020 012862



FEEDER WITH MOVABLE GRILL FOR CHICKS

Galvanised sheet metal. Trough of 4 cm depth. Width: 7 cm. With solid base.



Sku. 500001033 3 338020 012749

30 x 7 cm - 10 chicks

Sku. 500001050 3 338020 012756

50 x 7 cm - 20 chicks

Sku. 500001100 3 338020 035816

100 x 7 cm - 40 chicks
Limited stock



FEEDER WITH MOVABLE GRILL

Solid base. Galvanised sheet metal. Trough of 6cm depth. Width: 11 cm.



Sku. 500006050 3 338020 012817

50 cm - 6 hens

Sku. 500006075 3 338020 012824

75 cm - 10 hens

Sku. 500006100 3 338020 012831

100 cm - 15 hens



STANDARD ECONOMIC CHICK FEEDER

Standard quality feeder. A very good price to quality ratio. Dimensions: 50 x 7 cm.



Sku. 500000050 3 338020 085835

15 hens



Feeders

CIRCULAR CHICK BOTTLE HOLDER DRINKING TROUGH

Circular chick bottle holder drinking trough. Supplied with 3 adaptors for bottles.

Sku. 510004



15



AUTOMATIC CYLINDRICAL DRINKER ITALIAN MODEL

Plastic cylindrical automatic drinking trough, Italian model for poultry. Only suitable for low pressure. Delivered with 3m of hose in 12mm diameter and a pricking collar. Able to water 200-250 chickens. Spare parts available.

Sku. 510020



Tuyau 3 m Ø 12 mm



AUTOMATIC DRINKER FOR CHICKEN



This automatic drinking trough at constant level supports a pressure of up to 2 bar thanks to its very resilient valve. It is used both suspended and laid on the ground. It is also suitable for hens. Use the CHICK'A drinking trough with our antifouling disc for improved hygiene and time saving!

Sku. 510015001



1,5 L



RAPIDO DRINKER BUCKET 18L



This drinking trough has a bucket shape, it fills up like a bucket, convenient to carry with its broad handle. Drinking trough at constant level equipped with a float. Dimension Ø 30 x H 38 cm.

Sku. 517018



18 L



POULTRY DOUBLE CYLINDER DRINKING TROUGH



Drinking trough to place on the floor. With transport handle with bayonet fixing. Advantage of the product: can be used suspended. Available in 2 capacities. The double wall makes filling easier! **Feet available**, Sku. 509006001.

Sku. 510007006

6 L - 7 hens



Sku. 510007012

12 L - 14 hens



24



PLASTIC DRINKER



The basic, essential to water your hens! Simple, practical, resilient, shape studied specifically for poultry watering.

Sku. 510005001

1,5 L - 2 hens



Sku. 510005003

3 L - 4 hens



Sku. 510005005

5 L - 6 hens



Sku. 510005010

10 L - 12 hens





—
TRIPOD PLASTIC DRINKER

24 liters tank drinking trough in galvanised steel on steel tripod. The height of the drinking trough cup allows poultry to have permanently available good quality water.

Sku. 510005030



24 L



—
PLASTIC DRINKER WITH HANDLE

Ultra-practical for moving or filling the drinking trough due to its transport handle! Ideal shape to water the poultry. This drinking trough in highly resilient plastic has slits for mounting to prevent tipping over. Available in 3 capacities.

Sku. 510006005	5 L - 6 hens		
Sku. 510006010	10 L - 12 hens		
Sku. 510006015	15 L - 18 hens		



—
TRANSPARENT RED DRINKING TROUGH 5 L

Made of red plastic. Practical and easy to clean.

Sku. 510007005



5 L



—
SUSPENDED DRINKING TROUGH WITH PIPETTE 12 L

Ideal to keep clean water, this drinking trough is equipped with 3 multidirectional pipettes. The specific shape of the drinking trough allows it to be laid on the ground when filling without damaging the pipettes. Suitable for poultry of all ages. Delivered with a suspension kit.

Sku. 509010012		
12 L - 14 hens		



Feeders

ANTIFOULING DISC



A must for your backyard hygiene! This very practical antifouling disc is used with hoppers and CHICK'A drinking troughs. It will avoid dirt water or food, and will limit the risk of bacterial contamination. Significant interest, it will save you cleaning time.



Sku. 510016



12 L - 14 hens

Limited stock

FEEDER WITH GRILL



Poultry feeding tray in plastic, metallic grill. Available in 3 sizes.



Sku. 500008050



6 hens - 50 cm

Sku. 500008075



10 hens - 75 cm

Sku. 500008005



Chicks - 50 cm

PLASTIC FEEDERS



Hoppers for the feeding of the chicks, hens and other poultry. In very resilient plastic. Very hygienic and easy to clean. The 18/20 liters feeder comes with an anti-waste grill injected in one piece onto the central tube (no risk of loss). Optimal use with the anti-fouling CHICK'A disc (Sku. 510 016) for chicks up to 15 days old. 40% less loss and improved hygiene. To be placed every 5 meters.

Sku. 500015006

5 / 6 L - 6 hens



Sku. 500015010

8 / 10 L - 8 hens



Sku. 500015012

12 L - 10 hens



Sku. 500015020

18 / 20 L
13 to 15 hens



POULTRY | Vintage epoxy range

Feeders



FEEDER HOPPER USING RACK AND PINION

For a better coating! Delight in the vintage look of this feeder! Hopper with control of flow by rack and pinion. Delivered without base (Sku. 503122).

Sku. 503103  3 338020 085712

3 L - 4 hens

Sku. 503105  3 338020 085729

5 L - 6 hens

Limited stock

Sku. 503110  3 338020 085736

10 L - 8 hens

Sku. 503120  3 338020 085743

20 L - 15 hens



Drinkers



AWNING HOPPER OR DRINKING TROUGH

Single awning, in metal for rack and pinion feeder. Allows the use of enamelled hoppers outdoors Product suitable for the scattering of grain for small game.

Sku. 503111  3 338020 087334

Awning hopper or drinking trough
10 L - **Limited stock**



METAL DRINKING TROUGH IN GREY ENAMELLED SHEET METAL

For a better coating! You will love the vintage look of this drinking trough with filling valve.

Sku. 501003  3 338020 029808

3 L - 4 hens

Sku. 501005  3 338020 029815

5 L - 6 hens

Sku. 501010  3 338020 029822

10 L - 12 hens

Sku. 501020  3 338020 029839

20 L - 25 hens





The 1st CHICK'A range of eco-designed feeders and drinkers for an even more eco-citizen approach. Made from sugar cane and beets.



Plastic from 100% renewable resources. Natural dye.



Does not contain oil or oil derivatives.



POSITIVE CARBON FOOTPRINT.

Drinkers

GREEN LINE POULTRY DRINKING TROUGH

In plastic of superior quality. Practical. Easy to clean. Made from sugar cane and beets.

Sku. 509001001



1,5 L

Sku. 509001003



3,5 L

Sku. 509001005



5,5 L



GREEN LINE POULTRY DRINKING TROUGH FOR QUAIL 1,5 L

In plastic of superior quality. Practical. Easy to clean. Made from sugar cane and beets.

Sku. 509007001



1,5 L



POULTRY DOUBLE CYLINDER DRINKING TROUGH

With transport handle and feet. Double plastic wall allows a better filling! Delivered with feet. Made from sugar cane and beets.

Sku. 509006006

6 L + feet



Sku. 509006012

12 L + feet



Sku. 509006002

drinking through green feet x 4



24



POULTRY | Green plastic line

Feeders



Accessories



Pigeons



PLASTIC DRINKING FOUNTAIN

The essential friend of the dove-cote! Ideal shape for the pigeons. In plastic.

Sku. 710001  3 338020 014026

1,5 L



FEEDER WITH HOPPER + GREEN LINE GRILL

Made in plastic of superior quality. Practical, easy to clean. Made from sugar cane and beets.

Sku. 509002001 1 kg  3 700393 939822

Sku. 509002002 2,5 kg  3 700393 939839

Sku. 509002004 4 kg  3 700393 939853



GREEN LINE FEEDER WITH HOPPER ANTI-PESTS

Succumb to this ultra-convenient feeder with its reserve of 12 or 20kg. It makes life easier while taking care of your hens! Our UKAL experts have selected this feeding trough for its 4 advantages:

- Practical: The filling of the feeder is done on top with a hinged lid, moreover the pedal in plastic grill facilitates cleaning and avoids the accumulation of droppings.
- Protected: The feeder is opened by pressing the pedal, triggered by the weight of the animal. Pests (rats, mice, sparrows, etc.) cannot open it because they are too light.
- Resilient: Produced in galvanised sheet metal of quality, this feeder can remain outdoors thanks to its anti-rain system that prevents water from seeping inside.
- Rational: An anti-waste grill prevents a significant loss of food.

By adjusting the sensitivity of the pedal, this feeder is suitable for all species of ducks, hens, pheasants...

Sku. 509002110 12 kg  8 718426 007580

Sku. 509002120 20 kg  8 718426 007597



GRAIN MILL WITH BARREL

Easy to use, robust, reliable and safe, it is particularly suitable for small-scale breeding. It allows grinding and crushing of all types of cereals and dried vegetables. Grain mill with reserve barrel (50 liters). Delivered with 1 set of perforated grill diameter: 1,5 - 2,5 - 5 - 7 mm. Height 95 cm. Hourly flow: 20/40/90/170 kg.

Sku. 598100  3 338020 086221



PIGEON FEEDER

A beautiful plastic feeder, easy to clean. In red and yellow colour, it will brighten your backyard. Shape specifically tailored to the pigeons. Capacity 1,5 L.

Sku. 710002  3 338020 014057

1,5 L





RING WITH CLIPS

Easy to use and reliable. 4 diameters: 8, 12, 16 and 20 mm.



Sku. 540008101		3 338020 072842
8 mm white x 100		
Sku. 540008103		3 338020 072859
8 mm red x 100		
Sku. 540008106		3 338020 072866
8 mm blue x 100		
Sku. 540008108		3 338020 072873
8 mm green x 100		
Sku. 540008110		3 338020 072880
8 mm yellow x 100		
Sku. 540008119		3 338020 072897
8 mm orange x 100		

Sku. 540008201		3 700393 919084
8 mm white x 25		
Sku. 540008203		3 700393 919107
8 mm red x 25		
Sku. 540008206		3 700393 919145
8 mm blue x 25		
Sku. 540008208		3 700393 919268
8 mm green x 25		
Sku. 540008210		3 700393 919282
8mm yellow x 25		
Sku. 540008219		3 700393 919152
8 mm orange x 25		



Sku. 540012101		3 338020 072903
12 mm white x 100		
Sku. 540012103		3 338020 072910
12 mm red x 100		
Sku. 540012106		3 338020 072927
12 mm blue x 100		
Sku. 540012108		3 338020 072934
12 mm green x 100		
Sku. 540012110		3 338020 072941
12mm yellow x 100		
Sku. 540012119		3 338020 072958
12 mm orange x 100		

Sku. 540012201		3 700393 919299
12 mm white x 25		
Sku. 540012203		3 700393 919169
12 mm red x 25		
Sku. 540012206		3 700393 919176
12 mm blue x 25		
Sku. 540012208		3 700393 919183
12 mm green x 25		
Sku. 540012210		3 700393 919343
12 mm yellow x 25		
Sku. 540012219		3 700393 919336
12 mm orange x 25		



Sku. 540008101		3 338020 072965
16 mm white x 100		
Sku. 540016103		3 338020 072972
16 mm red x 100		
Sku. 540016106		3 338020 072989
16 mm blue x 100		
Sku. 540016108		3 338020 072996
16 mm green x 100		
Sku. 540016110		3 338020 073009
16 mm yellow x 100		
Sku. 540016119		3 338020 073016
16 mm orange x 100		

Sku. 540016201		3 700393 919350
16 mm white x 25		
Sku. 540016203		3 700393 919367
16 mm red x 25		
Sku. 540016206		3 700393 919190
16 mm blue x 25		
Sku. 540016208		3 700393 919404
16 mm green x 25		
Sku. 540016210		3 700393 919220
16 mm yellow x 25		
Sku. 540016219		3 700393 919237
16 mm orange x 25		



Sku. 540020001		3 700393 963087
20 mm white x 50		
Sku. 540020003		8 718426 005715
20 mm red x 50		
Sku. 540020006		8 718426 005609
20 mm blue x 50		
Sku. 540020008		3 700393 963117
20 mm green x 50		
Sku. 540020010		3 700393 963124
20 mm yellow x 50		
Sku. 540020019		3 700393 963131
20 mm orange x 50		



POULTRY | Plucker



FAMILY ELECTRICAL PLUCKER

Is used for plucking chickens, hens and all similar animals. Beforehand, the animals will have to be immersed in 50-60°C water for 2 to 3 minutes. They can then be plucked by placing them on the roller equipped with rubber fingers that removes the feathers by turning. Height: 75 cm. Max 6 kg.

Sku. 560005 

Family electrical plucker

Sku. 9560005001 

Feet for plucker

Sku. 560005001 

Fingers for plucker



PLASTIC POULTRY TRANSPORT CAGE

The perfect asset to transport your chickens! It has an upper opening thanks to a sliding door. It is also available with a side door. Dimensions: 95 x 58 cm.

Sku. 590020 

Upper door

Sku. 590021 

Upper door and side door



POULTRY CATCHER

Allows you to capture poultry more quickly.

Sku. 502010 



POULTRY SACRIFICE PLIERS



The subject must be suspended by the legs at a good height. Take the head in the left hand, press firmly with your thumb at the base of the skull. The beak of the poultry is then wide open. Insert the blade of the flat clamp so that it is placed in the bottom of the throat. Make a quarter turn with the clamp to bring it vertically so that the recessed part carried by the other branch of the clamp is placed on the skull, just behind the ridge, the tip of the blade must be at the bottom of the slightly inclined throat. When the clamp is in place, close it vigorously. The bleeding must be abundant, the muscles relax which allows a fast and efficient plucking.

Sku. 560001 



METAL CLAMP FOR WINGS



Prevents poultry from flying away. Operating advice: Close the wing of the poultry. Clamp the feathers of the arm and forearm, without touching the flesh. Screw by tightening strongly.

Sku. 560020  3 338020 013791
By 2 



PLASTIC FEEDING TUBE

For the force-feeding of geese. Plastic funnel, screw and metal. Very strong and effective.

Sku. 580020  3 700369 901204
Length 24 cm 



POULTRY RESTRAINING CONE

Fixed to the wall using the support Sku. 560002002.

Sku. 560002001  3 338020 063253

Bleeder funnel



Sku. 560002002  3 338020 063260

Bracket for bleeder funnel



RABBIT KILLER

To kill small animals and especially the rabbit without suffering. Equipped with a spring pressure, it causes instant death.

Sku. 560010  3 338020 082674



Hutch

BURGUNDY HUTCH

Capacity: 1 to 3 rabbits - Dimensions on the ground: 52 x 135cm - Dimensions overall: 65 x 145 x 101cm. The house for rabbits: summer or winter, this magnificent hutch will wonderfully accommodate rabbits and other rodents. Fully equipped: roof covered with asphalt canvas, shed 60x52x50cm, drawer for droppings, outdoor access door to the shelter, hatch between the shelter and the pathway, access ramp to pathway with grilling, 2 external access points to the pathway. In stained pine.

Sku. 595415 1 to 3 rabbits  3 700393 939716



Feeders and drinkers



RABBIT HOPPER WITH LID

In galvanised sheet metal. To fix on the doors of cages with bars. Height: 23 cm. Depth: 11 cm.

Sku. 600016 

1 compartment with lid

Sku. 600015 

2 compartments with lid

Sku. 600017 

3 compartments with lid



RABBIT HOPPER WITH PLASTIC LID

Automatic food distributor for rabbits. In plastic with protection against gnawing in galvanised metal. Locking mechanism. To hang in the cages. Ideal for a holiday.

Sku. 60001008 

1 compartment with plastic lid



RABBIT AUTOMATIC SOOTHER DRINKING TROUGH

Automatic water supply line at low pressure.

Sku. 610004 

By 3



BOTTLE HOLDER DRINKING TROUGH

Delivered with stand.

Sku. 610001002 

Ovale base

Sku. 610001003 

Rectangular base



ALUMINIUM RABBIT DRINKING TROUGH

Allows water supply by bottle (any type of bottleneck). Very easy installation.

Sku. 610001004 

By 4



BOTTLE HOLDER DRINKING TROUGH

Drinking trough oval base.

Sku. 610001010 

By 2



DRINKING PIPETTE FOR RABBIT



Filling and cleaning facilitated through an opening placed at the top. Robust pipette ensuring drop after drop for a good provision of drinking water.

Sku. 610003050 

0,5 L **Limited stock**

Sku. 610003100 

1 L



PLASTIC RABBIT DRINKING TROUGH

Drinking trough in resilient plastic. Easy filling from the top. Teat at 90°. Teat anti-drip mechanism. Fits easily on all types of cages. Capacity 1L.

Sku. 615100008 

1 L



AUTOMATIC RABBIT DRINKING TROUGH BY 2

A automatic water supply at low pressure. Fixation by plate Delivered in sets of 2.

Sku. 610040		3 338020 013920
By 2		16



PLASTIC HOSE & JUNCTION

Sku. 610041		3 338020 013937
Raccord droit x 5		
Sku. 610042		3 338020 013944
Jonction L x 5		
Sku. 610043		3 338020 013951
Jonction T x 5		
Sku. 610044		3 338020 013968
Jonction X x 5		



CERAMIC BOWL

Glazed. Heavy version.

Sku. 600018100		4 014803 305732
1 L		10
Sku. 600018750		4 014803 305961
750 ml		10
Sku. 600018500		4 014803 305725
500 ml		21
Sku. 600018250		4 014803 305954
250 ml		15



PLASTIC FEEDING TROUGH

Plastic, with heavy base to improve stability.

Sku. 710010		3 338020 048458
Double rectangular plastic feeding trough 750 ml		5
Sku. 710020		3 338020 048465
Single rectangular plastic feeding trough 500 ml		5
Sku. 710030		3 338020 048472
Round plastic feeding trough 500 ml		5



NOTES



UKAL

—
HEATING

- 90 INTERHEAT
- 90 PHILIPS
- 91 HORIZONT

HEATING



— INFRARED interHeat PROTECTORS - 250 W

Infrared protector, model meets CE standards and the French standard IPX4 (guaranteeing its compliance with sprinkling tests of electrical equipment). Usable with IR lamps from **100 to 250 W** and quartz reflectors. Ideal for keeping your chicks, calves, piglets and other animals warm under all circumstances. Delivered with attachment chain. 3 wires. Screwed sockets E27. Meets CE standards. 2 cable lengths available. Box of 10.

Sku. 116602  8 809078 175014

Simple infrared protector 5m of cable 

Sku. 116602001  8 809078 174017

Simple infrared protector 2.5m of cable. Unassembled 

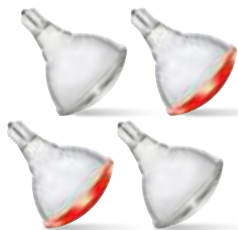

— IR LAMP interHeat INTERHEAT

Experience shows that their life expectancy is greater than traditional infrared light bulbs. Infrared heating bulb, **captive screw base**, guaranteed for life. Provides a regular warmth and improves the conditions of breeding for young animals. **Available in PAR glass.**

Sku. 116622150R  8 809078 172068

IR lamp red 150 W **Limited stock** 

Sku. 116622175B  8 809078 172075

IR lamp white 175 W **Limited stock** 

Sku. 116622175R  8 809078 172082

IR lamp red 175 W **Limited stock** 

Sku. 116622250R  8 809078 172105

IR lamp red 250 W **Limited stock** 

Sku. 116623100R  8 809078 176028

IR/PAR lamp screw red 100 W **Limited stock** 

Sku. 116623175R  8 809078 176042

IR/PAR lamp screw red 175 W **Limited stock** 



— INFRARED interHeat PROTECTOR WITH DIMMER SWITCH - 250 W

Infrared protector, model meets CE standards and the French standard IPX4 (guaranteeing its compliance with sprinkling tests of electrical equipment). Usable with IR bulbs from **100 to 250 W**. Ideal for chicks, lambs, piglets etc. Delivered with attachment chain. 3 wires. E27 screw socket. Meets CE standards. Equipped with a dimmer switch and 5m cable. Box of 10.

Sku. 116601  8 809078 175021

IR protector with dimmer switch 5 m of cable 



— IR PROTECTOR IPX4 - 175 W

Aluminium lamp holder. Cable length: 2,5m. Chain length: 2m. This infrared protector meets CE standards. For lamps **up to 175 W**. Delivered in a box, unassembled.

Sku. 116605  3 275970 068689

IR protector 

Sku. 116605001  3 275970 068696

IR protector with dimmer switch 

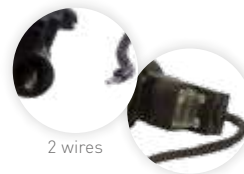

— IR PROTECTOR IPX4 - 250W

With ventilation slots for optimum air circulation. For normal or energy-saving infrared lamps up to **250 Watts**. Aluminium protection cage ø 21 cm with galvanised grid. Supplied with 2 m galvanised chain and ceiling hook (minimum suspension capacity 20 kg) GS/CE approved for more safety. Conforms to EN standard Splashproof (IPX4) with safety insulation E27 cap with silicone gasket.

Sku. 116610  3 700393 923128

IR protection 2,5 m 



— IR PROTECTOR IPX4 - 175 W

For normal or energy-saving infrared lamps with a maximum output of **175 Watts**. Rubber cord.

Sku. 116613  4 014803 326614

IR protection 5 m 

Sku. 116613001  3 700393 923111

IR protection 5 m with dimmer switch 



PHILIPS IR LIGHT BULB



Incandescent infrared Philips reflector lamps are designed for the toughest environments: farms, bathrooms, kitchens. They offer a reinforced structure through the use of hard glass. Their compact form and base of universal cawling allows them to be used with any adaptive equipment. Thermal lamps are a great way to produce warmth. They provide direct warmth without draught to animals, people and food. Tungsten filament lamps for instant response, with an average lifetime of 5,000 hours. Available in classic or PAR glass.

Sku. 116400100C		8 711500 493453
IR 100 W - white		10
Sku. 116400150C		8 711500 575227
150 W - white		10
Sku. 116400150R		8 711500 575203
IR 150 W - red		10
Sku. 116400250C		8 711500 575234
IR 250 W - white		10
Sku. 116400250R		8 711500 575210
IR 250 W - red		10

Sku. 116401100C		8 711500 128935
IR PAR 100 W white		12
Sku. 116401100R		8 711500 128911
IR PAR 100 W red		12
Sku. 116401175C		8 711500 128959
IR PAR 175 W white		12
Sku. 116401175R		8 711500 128980
IR PAR 175 W red		12



Advantages

- 90% of the energy is redistributed in infrared.
- Average lifetime of 5,000 hours.
- Instantly controllable radiant heat.
- Easy installation.

NEW

IR LIGHT BULB



Incandescent infrared reflector lamps are designed for the toughest environments: farms, bathrooms, kitchens. They offer a reinforced structure through the use of hard glass. Their compact form and base of universal cawling allows them to be used with any adaptive equipment. Thermal lamps are a great way to produce warmth. Please use the proper lamp holder, especially for the 250W, They provide direct warmth without draught to animals, people and food. Tungsten filament lamps for instant response, with an average lifetime of 5,000 hours. Available in classic or PAR glass. Really good price/quality ratio.

Sku. 116404100C		4 014803 308566
IR 100 W - white		9
Sku. 116404150C		4 014803 308504
IR 150 W - white		9
Sku. 116404150R		4 014803 459909
IR 150 W - red		9
Sku. 116404175C		4 014803 308511
IR 175 W - white		9
Sku. 116404175R		4 014803 308528
IR 175 W - red		9
Sku. 116404250C		4 014803 308535
IR 250 W - white		9

Sku. 116404250R		4 014803 459916
IR 250 W - red		9
Sku. 116405100C		4 014803 308542
IR PAR 100 W - white		9
Sku. 116405100R		4 014803 459923
IR PAR 100 W - red		9
Sku. 116405175C		4 014803 308559
IR PAR 175 W - white		9
Sku. 116405175R		4 014803 459930
IR PAR 175 W - red		9





NEW RANGE OF BULBS AVAILABLE

*Provide all the heating
needed by your animals!*



FROM 100 W TO 250 W
White and red bulbs.

UKAL    



UKAL

— IDENTIFICATION

- 94 Eartags
- 97 Collars and ankle straps
- 99 Temporary marking
- 101 Permanent marking

IDENTIFICATION | Eartags

HOW TO APPLY THE EARTAG CORRECTLY:

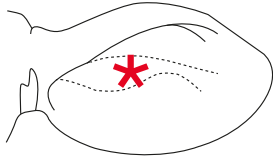

Always make a new hole. Dip the male part into antiseptic or disinfectant solution. Make sure the male part is on back of ear. Avoid penetrating cartilage and blood vessels.

1 Super Maxi + Button

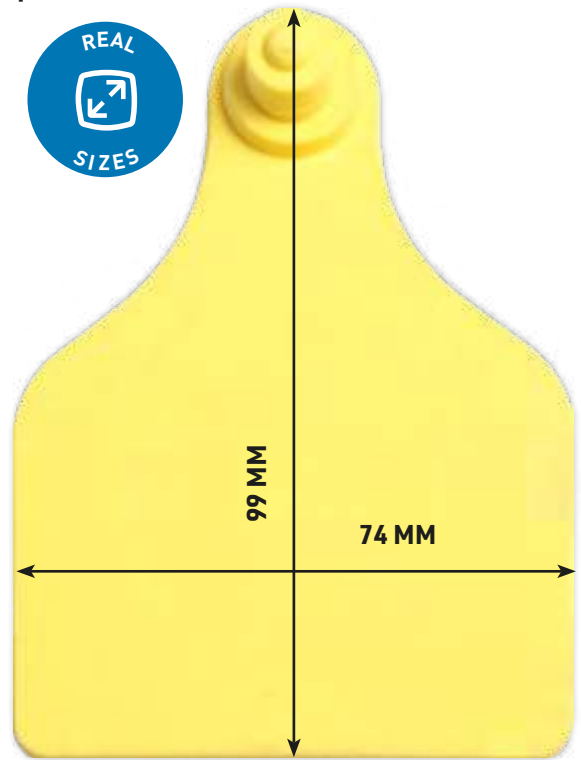

UKAFLEX MAXI + MAXI EARTAGS

Available in 8 sizes and 5 colors. Supplied in pack of 20 pairs. Can be marked with our different markers. For cattle, we recommend the size Maxi or Super Maxi. Metal pin. For more information, please have a look at the chapter on identification.



Type	Dimensions	Plain eartag white	Plain eartag red	Plain eartag blue	Plain eartag green	Plain eartag yellow	Printed laser 1 side	Printed laser 2 sides
1 Super Maxi + Button	99 x 74 mm	108068001	108068003	108068006	108068008	108068010	Upon request	Upon request
2 Maxi + Maxi	71 x 63 mm	108060001	108060003	108060006	108060008	108060010	108060100	108060200
3 Maxi + Button	Female part: 71 x 63 mm Male part: Ø 27 mm	108061001	108061003	108061006	108061008	108061010	108061100	108061200
4 Large + Button	Female part: 63 x 55 mm Male part: Ø 27 mm	108062001	108062003	108062006	108062008	108062010	108062100	108062200
5 Wide + Wide	45 x 55 mm	108063001	108063003	108063006	108063008	108063010	108063100	108063200
6 Wide + Button	Female part: 45 x 55 mm Male part: Ø 27 mm	108064001	108064003	108064006	108064008	108064010	108064100	108064200
7 Small + Small	45 x 55 mm Plastic pin	108066001	108066003	108066006	108066008	108066010	108066100	108066200
8 Button + Button	Ø 28 mm	108067001	108067003	108067006	108067008	108067010	-	-

2 Maxi + Maxi

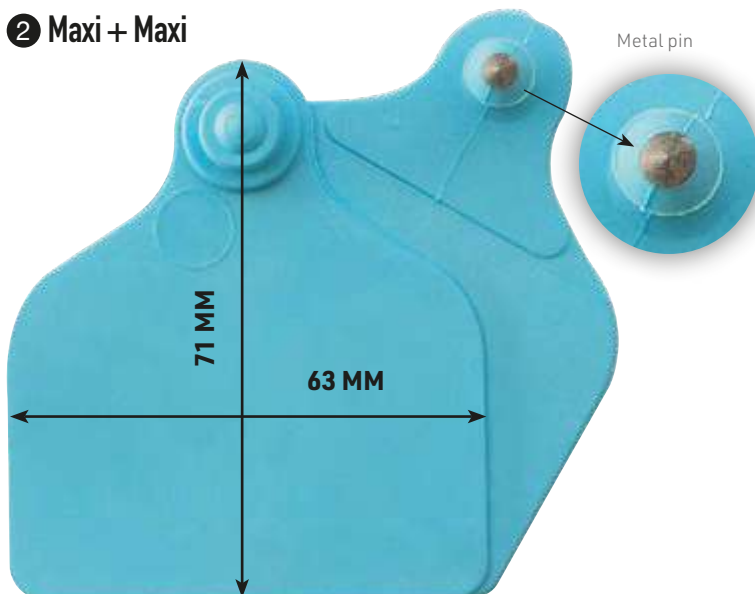

3 Maxi + Button

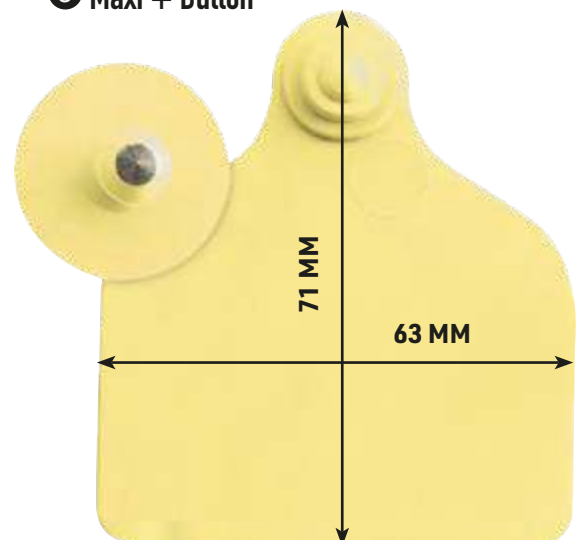

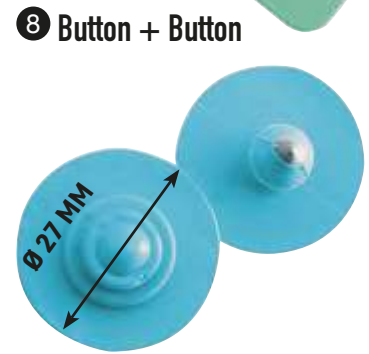
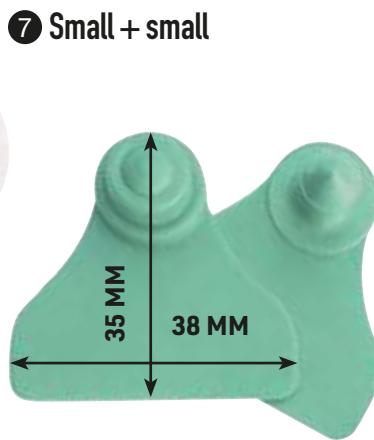
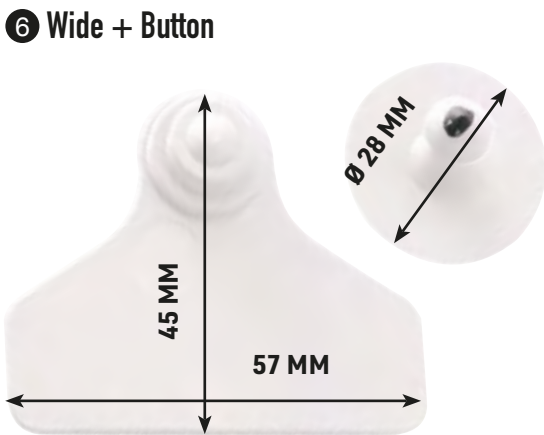
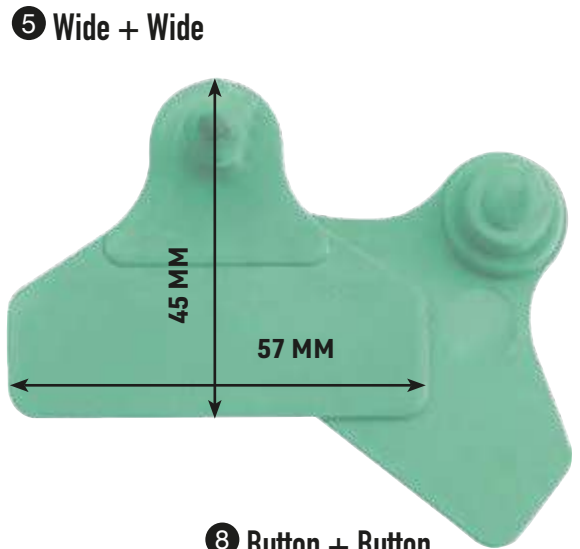
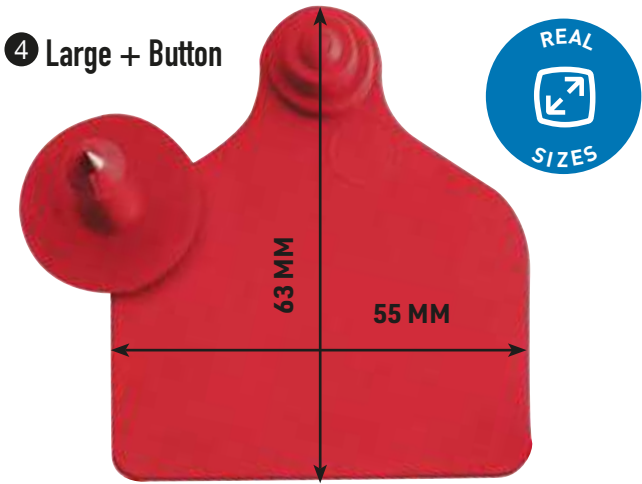



MAXI + MAXI

Eartags. By 20.

Sku. 108060001 	Sku. 108060008 
White 	Green 
Sku. 108060003 	Sku. 108060010 
Red 	Yellow 

MAXI + BUTTON

Eartags. By 20.

Sku. 108061001 	Sku. 108061006 
White 	Blue 
Sku. 108061003 	Sku. 108061010 
Red 	Yellow 

SUPER MAXI + BUTTON

Eartags. By 20.

Sku. 108068001 	Sku. 108068006 
White 	Blue 
Sku. 108068010 	Sku. 108068008 
Yellow 	Green 

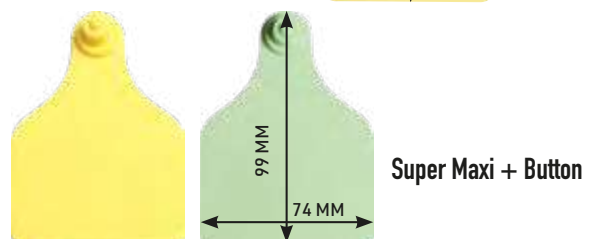
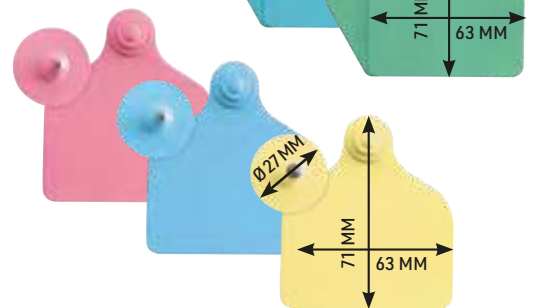
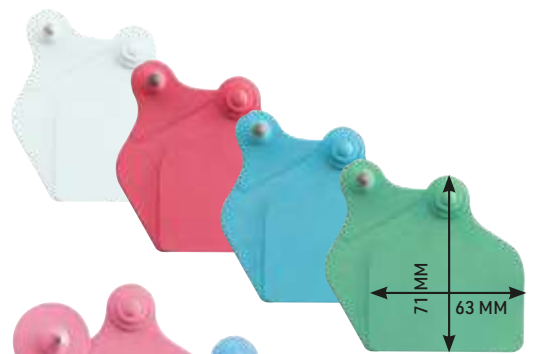

IDENTIFICATION | Eartags

APPLICATOR FOR UKAFLEX EARTAGS



Complete with 2 universal pins. Can be used with most cattle eartags on the market. Can be used to apply Ukal-Flex, Kelflex and Allflex eartags.

Sku. 108000		3 338020 003020
Applicator with 2 universal pins		
Sku. 108000002		3 700393 930904
Universal pin x 2		

BLACK MARKER



Smear proof markers to mark sheep collars, neck tags, ankle straps and all kinds of eartags. Reistant to contact with organic matter, bases and acids.

Sku. 108280001		3 338020 066735
Fine tip		
Sku. 108280003		3 338020 066742
Round tip		



UKALTAG EARTAGS

UKAL

Ukaltag eartags are made of high quality nylon (nylon 6-6). The standard version of the eartags is available in several U.V. resistant colours. Dimensions: 3 x 1 cm. Special printings can be made on request. Tags can be printed on both sides as follows: - consecutive numbers. - 8 fixed numbers. - 8 fixed characters (letters, numbers). Supplied by 100 pairs.

PRINTING FROM 1 TO 100

	Sku. 109922001		3 338020 007783
	Sku. 109922003		3 338020 007806
	Sku. 109922006		3 338020 007820
	Sku. 109922008		3 338020 007837
	Sku. 109922010		3 338020 007844

PRINTING FROM 101 TO 200

	Sku. 109922101		3 338020 007882
	Sku. 109922103		3 338020 007905
	Sku. 109922106		3 338020 007929
	Sku. 109922108		3 338020 007936
	Sku. 109922110		3 338020 051571

LASER PRINTING 1 OR 2 SIDES

	Sku. 109922701		3 338020 078936
	Sku. 109922703		3 338020 078943
	Sku. 109922706		3 338020 078950
	Sku. 109922708		3 338020 078967
	Sku. 109922710		3 338020 078974



UKALTAG APPLICATOR

UKAL

Can be used with most sheep eartags available on the market.

Sku. 109925	Metal		3 338020 008087
--------------------	-------	--	-----------------



PLASTIC COLLAR FOR SHEEPS

KAMER



Very solid and resistant to chemicals. With safety catch fastening. Can be marked with marking pen. Sold in set of 5. Length: 57.5 cm.

	Sku. 121151010	Yellow - By 5		
	Sku. 121151003	Red - By 5		
	Sku. 121151019	Orange - By 5		
	Sku. 121151006	Blue - By 5		
	Sku. 121151008	Green - By 5		
	Sku. 121151002	Black - By 5		

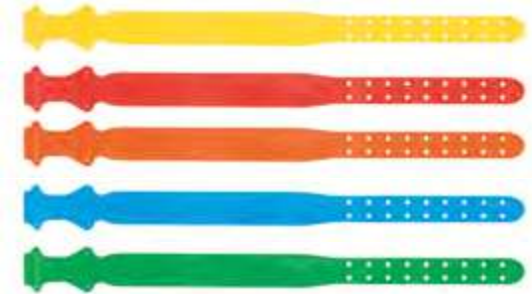

NYLON COLLAR FOR SHEEPS

KAMER



Adjustable. With D-ring to put a lanyard. Very sturdy and reinforced leather, they are suitable for all types of sheep. Length about 65 cm. Width: 2,5 cm. By unit.

	Sku. 121152006	Blue		
	Sku. 121152008	Green		
	Sku. 121152010	Yellow		



SELF-ADHESIVE FLUORESCENT ANKLE STRAP FOR COWS

KAMER



Very resistant and easy to put on and remove. Better hold due to a plastic loop. Allows a fast identification of the cow and udder (1 leg = 1 teat). Facilitates use of colour coding in case of any treatment. Fluorescent colours for a very good visibility. Long. Sold in bag of 5 ankle straps. Dimensions: 3,8 x 41 cm.

	Sku. 108701008	Fluorescent Green By 5		
	Sku. 108701010	Fluorescent Yellow By 5		
	Sku. 108701019	Fluorescent Orange - By 5		
	Sku. 108701021	Fluorescent Pink By 5		



NEW

PLASTIC STRAP FOR COWS

KAMER



Extra long model. Easy to use. Precise tightening by non-return catch. Use these bright neon coloured straps for all temporary i.d. needs. Approx. 340 mm long. In pack of 10.

	Sku. 108811003	Fluorescent Cherry By 10		
	Sku. 108811008	Fluorescent Green By 10		
	Sku. 108811010	Fluorescent Yellow By 10		



IDENTIFICATION | Collars and ankle straps



NYLON COW COLLAR

KAMER

Can be used with strap digits. Nice finish. Length: 120 cm. By unit.

	Sku. 121160	Yellow and black	3	
	Sku. 121160003	Red	3	
	Sku. 121160006	Blue	3	
	Sku. 121160008	Green	3	



PLASTIC IDENTIFICATION STRAP DIGITS

KAMER

Fits on most collars, halters, straps. Each digit is 4 cm - 2" high. Printed with 1 digit. In pack of 10.



Sku. 108906050	0	3	
Sku. 108906051	1	3	
Sku. 108906052	2	3	
Sku. 108906053	3	3	
Sku. 108906054	4	3	
Sku. 108906055	5	3	
Sku. 108906056	6 / 9	3	
Sku. 108906057	7	3	
Sku. 108906058	8	3	



MULTI-LINE MARKING SPRAY

Livestock spray marker specifically formulated for short-haired animals. Non aggressive formula. Box of 12. 500 ml.



Sku. 108312103		3 338020 045563
Red		12
Sku. 108312106		3 338020 045570
Blue		12
Sku. 108312108		3 338020 045587
Green		12

MARKING SPRAY RAIDEX

Specifically formulated for marking cattle, pigs, and short-haired animals. Delivered in box of 12. 500 ml.



Sku. 108307003		4 019726 005332
Red		12
Sku. 108307006		4 019726 005356
Blue		12
Sku. 108307008		4 019726 005363
Green		12



OVI-LINE MARKING SPRAY

High quality formula specifically for marking wool, long or short. Long lasting (2 months). Composition: contains lanolin. The Ovi-line spray meets the highest standards of the wool industry. The quality of the paint and lanolin-based marker allows for legible and long-lasting marking (2-3 months). The Ovi-line spray is the only spray which allows the mother and lamb to be marked at lambing with a quantity comparable to paint marking. To mark a number with the spray, hold the tip 5-6 cm from the fleece and write the number by moving the can like a marker. 500 ml. Delivered in box of 12.



Sku. 108316003		3 338020 042432
Red		12
Sku. 108316006		3 338020 042449
Blue		12
Sku. 108316008		3 338020 042456
Green		12

MARKING SPRAY RAIDEX FOR SHEEP

RAIDEX sheep marking spray is suitable for marking sheep and lambs. It is an advancement of the established RAIDEX sheep branding fluid and offers improved drying and washability. It contains harmless, light-fast pigments, mildly-odorous solvent, lanolin grease and natural resins. This composition achieves good drying and removal during the wool wash. 500 ml. Supplied by box of 12. Reference 108308003 to 108308021. The markings/numbers are applied by spraying from a distance of 10-15 cm. RAIDEX sheep branding fluid dries within 4 to 8 hours depending on ambient temperature and consistency of the dye. As these fluids take several hours to dry, care must be taken to prevent contact with the dye and hence smudging. The dye markings wash out if conventional wool washing is employed. The dye markings should be left on the animal for approx. 4-6 weeks in order to guarantee washability. Ensure that the markings are applied to sheep in an appropriate place, e.g. head or legs.



Sku. 108308002		4 019726 054088	Sku. 108308020		4 019726 054040
Black		12	Purple		12
Sku. 108308003		4 019726 054033	Sku. 108308019		4 019726 054026
Red		12	Orange		12
Sku. 108308006		4 019726 054057	Sku. 108308021		4 019726 054071
Blue		12	Pink		12
Sku. 108308008		4 019726 054064			
Green		12			
Sku. 108308010		4 019726 054019			
Yellow		12			

IDENTIFICATION | Temporary marking





RAIDEX MARKING STICK

RAIDEX





Sticks made of special waxes and paraffin oil. We use high-quality pigments to achieve an excellent colour quality. The sticks are set apart by effective writing capability on hide, temperature stability, colour intensity and high luminance. The ingredients are harmless for humans or animals. By 3 (108303003 to 108303020), by 10 (108304002 to 108303020) and by 50 (108305021). Packaging and any unused materials can be discarded with residual waste. The marking remains visible on the upper back of cattle and sheep for approx. four weeks. Please note that markings on sheep are impossible or difficult to wash out. They should therefore be applied in a more suitable place, e.g. head or legs.

Sku. 108303003 

 Red - By 3 

Sku. 108303006 

 Blue - By 3 



Sku. 108303008 

 Green - By 3 

Sku. 108303020 

 Purple - By 3 

Sku. 108303100 

 Red - Blue - Green 

Sku. 108304002 

 Black - By 10 

Sku. 108304003 

 Red - By 10 

Sku. 108304006 

 Blue - By 10 

Sku. 108304008 

 Green - By 10 

Sku. 108304010 

 Yellow - By 10 

Sku. 108304019 

 Orange - By 10 

Sku. 108304020 

 Purple - By 10 



BLOCK FOR HARNESS

RAIDEX



RAIDEX wax blocks consist of high-quality special waxes and paraffin oil. We use high-quality pigments to achieve an excellent colour quality. The ingredients are harmless for humans or animals. RAIDEX wax blocks can be used at any temperature without any problem. To be stored between 5 and 25 degrees. For cattle and sheep.

Sku. 108601002 

 Black 

Sku. 108601003 

 Red 

Sku. 108601006 

 Blue 

Sku. 108601008 

 Green 

Sku. 108601010 

 Yellow 

Sku. 108601019 

 Orange 



SUPER BLUE HARNESS FOR RAMS

KAMER



The new Super blue harness has been specially designed by animal breeders. Easy to use and to adjust. Very resistant. Easy maintenance. Padded straps prevent cuts and chafing. Nylon.

Sku. 108605006 

Nylon 



HARNESS FOR RAMS

KAMER



The new Super blue harness has been specially designed by animal breeders. Easy to use and to adjust. Very resistant. Easy maintenance. Padded straps prevent cuts and chafing. Nylon.

Sku. 108605 

Nylon 



EAR NOTCHER

KAMER



Nickel-plated steel. Very sharp for a neat cutting. Available in 5 shapes.



Sku. 108400010	10N		
Sku. 108400011	11N		
Sku. 108400012	12N		
Sku. 108400013	13N		
Sku. 108400014	14N		

SHEEP MARKING FLUID

To be used with marking numbers (Sku. 108430-440). Specific composition which respects the wool. Completely washable, leaves no residue in the wool. 4 kg container.



 Sku. 108455003	Red	 3 509392 535857	
 Sku. 108455006	Blue	 3 509392 535819	
 Sku. 108455008	Green	 3 509392 535895	

MARKING NUMBERS 0-9

KAMER

Only to be used with Master laine sheep marking fluid. Made of aluminium (Sku. 108455003, -006, -008). Set of 9 number from 0 to 9 (6 and 9 are the same). Available in 2 sizes.

Sku. 108430	8 cm	 3 338020 005413
Sku. 108440	10 cm	 3 338020 005512



Permanent marking

BLACK TATTOOING PASTE **RAIDEX**

Veterinary quality paste. Can be applied with finger. Massage areas to be tattooed with paste. Black.

Sku. 109175600  4 019726 000689

600 g jar



BLACK TATTOOING INK

UKAL

High quality tattooing ink, intense black. Apply with a small brush on area to be tattooed or used in the ink pad for pig tattooing hammers. Ready to use. Density 1,24/1,25 g/liter.

Sku. 109946100  3 338020 008155

1 L





UKAL

— ELECTRIC CLIPPING

- 104 **Clippers for cattle and horse**
- 106 **Blades for cattle and horse**
- 107 **Clippers for sheeps**
- 108 **Combs for sheeps**
- 112 **Trimmers**
- 113 **Blades**
- 115 **Accessories and care**



HEINIGER IS THE WORLD NUMBER 1 IN ANIMAL SHEARING

Founded in 1946, Heiniger quickly established a good reputation as a manufacturer of quality products and agricultural services. Following the great success of exports, the product range and sales were widened. Worldwide, millions of animals are shorn with Heiniger products. Heiniger instruments are designed for precise shearing, clean and fast. Each shear corresponds to a type of animal so that all clippings, even the most difficult, can be easily accomplished with the right tools. Discover the range, perfect for shearing your horse, cattle, sheep with a 2 year warranty provided by UKAL Livestock France. A 30 years partnership.



DISCOVER OUR WEBSITE

www.heiniger.fr



XPERIENCE ELECTRIC CLIPPER 2 SPEEDS



The XPERIENCE clipper is the perfect balance between power and lightness. It will fulfil all your shearing needs for horses and cattle. Thanks to its unique ergonomic design, it ensures a perfect grip making for fatigue-free working. The innovative connecting system between the cutting head and the reinforced body, coupled with a powerful engine, ensure a long-life use. Light, sleek and silent. The XPERIENCE clipper will satisfy your needs of quality, style and precision. Supplied in a box including operating instructions, screwdriver, cleaning brush, oil. **Power: 250 W. Weight: 1180 g. Noise: 68 dB(A). Motor speed: 2600/2900 rpm. Power supply: 240 V. Supplied with 21 and 23 teeth blade set/ screwdriver/brush/oil.**

Sku. 100272001

On mains



CORDLESS CATTLE XPLORER



The Xplorer accumulator clipper is the latest technological innovation. The perfect tool for cattle and horse clipping. Wireless, it has up to 2 hours run time and offers more flexibility thanks to its wireless system. Practical thanks to LED charging indicator. No disturbing air output. No power loss due to the development of the dual pinion drive. Strong and durable thanks to its fibreglass reinforcement. The Xplorer clipper meets all requirements in the field of shearing horses and cattle. **2600mAh Li-Ion battery with no memory effect.** Li-Ion high performance 3-cell. Safety certification: CE/electrosuisse Delivered in a box including operating instructions, screwdriver, cleaning brush, oil. **Fitted with a 21/23 teeth combs set. Weight: 990 g. Noise: 65 dB(A).**

Sku. 100264

Supplied with 1 battery + 1 charger



Sku. 100264001

1 extra battery



NEW

CORDLESS XPLORER PRO - 2 SPEEDS

Heiniger



Heiniger revolutionises cattle and horse clipping with its new XplorerPro clipper. Ever more powerful than its predecessor, the XplorerPro features two speeds and is the only clipper to date to include a patented clipping pressure display. This guarantees more precise clipping than ever before and also extends the clipper's life.

Delivered with a carrying case including a set of 21/23 teeth combs, instructions for use, screwdriver, cleaning brush, oil and a charging station.

Features :

- **2 speeds: 2450 et 2 900 double strokes per minute**
- Battery capacity: 2850 mAh
- Battery run time: approx. 120 min
- Battery charging time: approx. 90 min
- Sound pressure level: approx. 65 dB
- Integrated battery charge indicator
- Handy and light: 975 g
- Length: 300 mm

2 YEARS WARRANTY.



Sku. 100264004 Supplied with 1 battery + 1 charger 7 613073 065581

Sku. 100264005 1 extra battery 7 613073 063846

PROGRESS - ELECTRIC CLIPPER FOR HORSE

Heiniger



Equipped with last generation electronic features, the Progress clipper is now even more powerful and user-friendly. Thanks to its ultra-streamlined handle, its light weight and its low-noise running, it is the best solution for nervous horses shearing. Particularly well suited to women's hands. Adaptable with combs from the other clippers. Also suitable for cattle finishing touch. Performance: 80 W. Speed: 2200 oscillations/min. Length: 280 mm. 5 m wire. Weight: 930 g. Noise emission: 70 dB. **Mounted with: 31/15 teeth combs.** Supplied in a storage box with instruction manual, screwdriver, cleaning brush and oil.



Sku. 100268 On mains 3 338020 087570

TAILWELL MK2

The use of Tailwell 2 facilitates shearing cows tail hair to ensure optimum hygiene of the cattle. Silent, fast and safe shearing. Works with 14V cordless screwdrivers, 1250 rpm. Supplied with the cutting head, 1 bottle of lubricant for the blades and 1 syringe for the lubricant. Supplied without screwdriver.



Sku. D100500 9 417027 206703



DISCOVER THE VIDEO

ELECTRIC CLIPPERS | Blades for cattle and horse ans clippers for sheeps



FAST CLIPPING



Sku. 100246SET



Blade set 18 and 23 teeth



SPECIAL BLADE SET CHAROLAIS



Sku. 100242SET



Blade set 18 and 15 teeth



Sku. 100247015



15 teeth cutter



ALL-ROUND BLADE SET FOR CATTLE



Sku. 100244SET



Blade set 21 and 23 teeth



Sku. 100246



21 teeth comb



Sku. 100245



23 teeth cutter



BLADE FOR VETERINARY USE



Sku. 100241SET



Blade set 53 and 23 teeth



Sku. 100241053



53 teeth comb



Sku. 100245



23-teeth cutter



Clippers for sheeps



XPERT SHEARING 240 V 2 SPEEDS



The latest machine by Heinger, Xpert is a powerful, yet still ergonomic and lightweight machine. **2 speeds.** The unique, innovative, stable connection between the shearing head and the fibreglass-reinforced housing ensures low vibration shearing. Silent. This shearing machine will amaze anyone who shears. Supplied in an extra-strong carrying case including a set of combs, screw driver, oil bottle, brush and user manual. Manufactured in Switzerland. **Fitted with OVINA PREMIUM comb set. Weight: 1180 g, noise: 79 dB. Power supply: 240 V / 200 W. Motor speed: 2500/2800 rpm.**

Sku. 100279001 On mains



SHEEP CLIPPER XTRA 320 W



Large head, powerful engine. Equipped with an exclusive clipping system. Less vibrations. The motor consists of a 320 watts and 2400 cycles per minute. The sheep clipper is equipped with a large head and comes with Ovina Premium. This powerful electric HEINGER sheep clipper is supplied in a case. Weight: 1530 g. Noise: 80 dB. Power supply: 220-240 V.

Sku. 100280 On mains



Sku. 100281 Shearing head only



Sku. 100145 Motor only



Sku. 9H100280 Maintenance kit for sheep clipper XTRA 10 control points



ONE PROFESSIONAL SHEARING PLANT 300 W



Ideal for shearing big herds. Thanks to its ICON handpiece the ONE shearing plant is very compact and easy to handle. The powerful electric motor allows you to shear sheep and goats. Supplied with a flexible shaft of 200 cm and ICON handpiece. Available in WORM DRIVE or PIN DRIVE. **Color non contractual.**

Sku. 100123001	ONE professional shearing plant 300 W WORM DRIVE		7 613073 002272
Sku. 100123002	ONE professional shearing plant 300 W PIN DRIVE		3 700393 903861
Sku. 100123005	Wall mount		3 338020 081363



PIN DRIVE



WORM DRIVE

EVO PROFESSIONAL SHEARING PLANT 300 W



The HEINIGER professional shearing plant is the only one in the world equipped with an electrical safety device with an international ratification certificate. **3 speeds:** 2700, 3200 and 3500 rpm. An autoadjustable belt ensures the transmission. It is protected by a very sturdy case made of synthetic material reinforced by fiberglass. **Color non contractual.** Noise: 70 dB.

Sku. 100124100	EVO professional shearing plant 300 WORM DRIVE		7 613073 000391
Sku. 100124200	EVO professional shearing plant 300 PIN DRIVE		3 338020 084128
Sku. 100124101	Flexible shaft WORM DRIVE		3 338020 084135
Sku. 100124201	Flexible shaft PIN DRIVE		3 338020 084142



PIN DRIVE

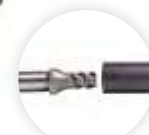

WORM DRIVE

ICON HANDPIECE FOR PROFESSIONAL SHEARING PLANTS



Quality handpiece provides top professional shearing. Ergonomical form for a better grip or handle. Supplied without comb and cutter. **Color non contractual.**

Sku. 100122030		3 338020 039715
-----------------------	--	-----------------

PIN DRIVE



Sku. 100122031		3 338020 079100
-----------------------	--	-----------------

WORM DRIVE



ICON FX - HANDPIECE



The significantly lighter weight requires less energy to stop momentum and minimises the effort required for every blow. The slimmer shape barrel ensures a superb grip and provides maximum in-hand comfort. The precise weight distribution provides superior balance and handling to deliver easier manoeuvrability. 10 % lighter handpiece. Now even slimmer. Optimum balance. Ergonomic.

Sku. 100122302		7 613073 059863
-----------------------	--	-----------------

WORM DRIVE





ELECTRIC CLIPPERS | Combs for sheep clippers



UKAL RECOMMENDS THE WORM DRIVE TIP FOR MORE SECURITY

EVO PROFESSIONAL SHEARING PLANT WITH RIGID SHAFT

Comes with rigid shaft WORM-DRIVE and ICON handpiece. 3 speeds: 2700, 3200 and 3500 rpm.







Sku. 100124300	EVO with shaft	
Sku. 100122020	Shaft only	

Combs

FINE WOOL AND DENSE FLEECE











Specially designed for shearing animals with fine wool or dense fleece such as sheep or goats. 13 high-quality teeth for easy shearing. Used by experienced shearers.

Sku. 100255SET	
13 and 4 teeth blade set	
Sku. 100256	
13 teeth comb	
Sku. 100253	
4 teeth cutter	

CLASSIC SHEARING & PREMIUM



For Heiniger sheep clippers. Classic shearing and fine wool and dense fleece. The Ovina Premium comb set is equipped with the new LG2 technology.

Sku. 100252SET	
13 and 4 teeth blade set	
Sku. 100254	
13 teeth comb	
Sku. 100253	
4 teeth cutter	
Sku. 100253SET	
Ovina Premium blade set	

ESPECIALLY FOR CATTLE



Heiniger clipper comb, specially designed for shearing cattle. 25 and 4 tooth blade set. **Only works on sheep clippers.**

Sku. 100257SET	
25 and 4 teeth blade set	

ESPECIALLY FOR MERINO WOOL



Sku. 100261SET	
13 and 4 teeth blade set	

ESPECIALLY FOR CAMELIDS



Sku. 100256SET	
13 and 4 teeth blade set	



Combs for winter shearing

PRO BLIZZARD COMB



Box of 2 combs.

Sku. 100100018



Size: 94,5 mm



HIGHLANDER COMB



Box of 2 combs.

Sku. 100100042



Size: 98 mm



ISOBAR COMB



Box of 2 combs.

Sku. 100100041



Size: 98 mm



CRUSADER COMB



Box of 2 combs.

Sku. 100100043



Size: 94,5 mm



Cutters

XTREME CUTTER



Box of 10 combs.

Sku. 100100106



Size: 3,7 mm



PRO JET CUTTER



Box of 10 combs.

Sku. 100100100



Size: 4,4 mm



STORM CUTTER



Box of 10 combs.

Sku. 100100107



Size: 4,6 mm



DIAMOND CUTTER



Box of 10 combs.

Sku. 100100102



Size: 3,7 mm

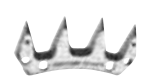

EDGE CUTTER



Box of 10 combs.

Sku. 100100108



Size: 4,4 mm



For broad wool



CHARGER COMB



Box of 5 combs.



Sku. 100100016



Size: 93,5 mm.
Right hand

Sku. 100100017



Size: 93,5 mm.
Left hand



SUPER CHARGED COMB



Box of 5 combs.



Sku. 100100006



Size: 93,5 mm



WARRIOR COMB



Box of 5 combs.



Sku. 100100001



Size: 96 mm



QUANTUM COMB



Box of 5 combs.



Sku. 100100012



Size: 95 mm.
Right hand



QUAZARD COMB



Box of 5 combs.



Sku. 100100005



Size: 95 mm



CONDOR COMB



Box of 5 combs.



Sku. 100100024



Size: 98 mm



CALIBRE COMB



Box of 5 combs.



Sku. 100100044



Size: 93,5 mm



XLR-8 COMB



Box of 5 combs.



Sku. 100100039



Size: 98 mm

For fine wool



PRO AWESOME COMB



Box of 5 combs.



Sku. 100100010



Size: 92 mm



XPRESS COMB



Box of 5 combs.



Sku. 100100009



Size: 93,5 mm

FREESTYLE COMB



Box of 5 combs.

Sku. 100100036



Size: 96 mm.
Right hand

Sku. 100100046



Size: 96 mm.
Left hand



HUGE COMB



Box of 5 combs..

Sku. 100100029



Size: 96 mm

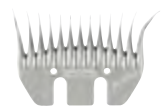

PRO REBEL COMB



Box of 5 combs.

Sku. 100100032



Size: 92 mm



BAD COMB



Box of 5 combs.

Sku. 100100004



Size: 95 mm



FREAK COMB



Box of 5 combs.

Sku. 100100034



Size: 94,5 mm



B-EVIL COMB



Box of 5 combs.

Sku. 100100002



Size: 94,5 mm



Universal comb

PRO RAPIER COMB



Box of 5 combs.

Sku. 100100021



Size: 86 mm



REFLEX COMB



Box of 5 combs.

Sku. 100100037



Size: 94 mm



PRO LEGEND COMB



Box of 5 combs.

Sku. 100100014



Size: 92 mm



PROFLEX COMB



Box of 5 combs.











Sku. 100100038



Size: 94 mm



ELECTRIC CLIPPERS | Combs

		PRO OVINA COMB				OVINA PREMIUM COMB	
		Box of 5 combs.					Box of 5 combs.
		Sku. 100100025					Sku. 100100028
		Size: 77 mm					comb with LG2 technology. Ovina Full thickness. 77 mm wide / Medium Bevel
		TOPAZ COMB					
		Box of 5 combs.					
		Sku. 100100030					
		Size: 84,5 mm					

Saphir clippers



CORDLESS PROFESSIONAL TRIMMING CLIPPER SAPHIR



For small animals and veterinary care. Up to 90min clipping time per battery with high performance lithium-ion technology. Additional battery pack and less than 60min charging time for continuous clipping. The perfect clipping machine for trimming cattle or for Cow-Styling. Detachable Saphir blade system compatible with clippers from Andis, Moser, Oster and Wahl. Supplied with clipping blades, 2 batteries, charger unit, oil, brush and instruction manual. Power: 35 W. Weight: 440g. Noise: 63 dB. **Motor speed: 2650 rpm.** Dimensions: 204 x 50 x 41 mm.

Sku. 154400

2 batteries



SAPHIR STYLE CORDLESS PROFESSIONAL TRIMMING CLIPPER



For small animals and veterinary care. Low-noise and high-performance 35 W permanent magnet motor. High performance battery with the latest lithium-ion technology for continuous clipping. Over 90 minutes of clipping time with less than 60 minutes of charging time. Highquality charger with additional charging dock for 2 batteries and with charging indicator. Large selection of interchangeable clipping blades, compatible with Andis, Moser, Oster and Wahl. Supplied with clipping blades, two batteries, charger unit, oil, brush and instruction manual. Power: 35 W. Weight: 440g. Noise: 63 dB. **Motor speed: 2650 rpm.** Dimensions: 204 x 50 x 41 mm

Sku. 154405

2 batteries



SAPHIR CORD PROFESSIONAL CLIPPER



For small animals and veterinary care. The latest technology coupled with a new design. A clipper with exceptional technical qualities specifically developed for shearing small animals. A wide selection of interchangeable cutting heads. A powerful and innovative clipper that is quickly becoming an essential tool for the professional shearing of small animals. Operates on mains power, with 3 m of cable. Power: 35 W. Weight: 330g. Noise: 63 dB. **Motor speed: 3200 rpm.** Dimensions: 204 x 50 x 41 mm. Operates on mains power with 3 m of cable.

Sku. 154410 On mains 



CORDLESS PROFESSIONAL TRIMMING CLIPPER SAPHIR BASIC



For small animals and veterinary care. Up to **90 minutes** clipping time per battery with high performance lithium-ionic technology. The perfect clipping machine for the trimming of cattle and horses or for cow-Styling. Detachable Saphir blade systems compatible with clippers from Andis, Moser, Oster and Wahl. Supplied in a resistant and practical case, with clipping blades, 1 battery, oil, brush and instruction manual. Power: 35 W. Weight: 440 g. **Motor speed: 2650 rpm.** Dimensions: 204 x 50 x 41 mm. Noise: 63 dB.

Sku. 154415 1 battery 



CORDLESS BATTERY 2 SPEEDS CLIPPER OPAL



The Opal is extremely quiet. It is also impressively powerful and equipped with **two speed levels**. With 3100 oscillations per minute in fast mode (and 2600 in slow mode), this clipper works smoothly and quickly even through dirty and thick fur and hair. The latest lithium-ion battery technology ensures cordless clipping **for 240 minutes**. It takes just one hour for a full battery recharge. Thanks to the built-in battery level indicator, it is always possible to check the remaining battery time. Opal has a cutting-edge ergonomic design and fits perfectly in the hand. Moreover, this clipper is particularly small and lightweight. Professionals can thus work effortlessly – whether for grooming, veterinary applications or dog, horse and cow styling. Noise: 63 dB. **Speed: 2600/3100 db/min.** (Available with 2 batteries on demand)

Sku. 154420 1 battery 



NEW



STYLE MINI CLIPPER

Heiniger's STYLE MINI clipper has a new lithium-ion battery technology that extends its operating time to 120 minutes. Ideal for clipping small animals and veterinary care. It will provide ultra-precise and fine mowing, with a 30 mm precision steel cutting head and an even more powerful motor. Ideal for the final styling of the dog. The adjustable shoe allows a cutting length of 3 to 6 mm. Quiet, low-vibration and cordless, it offers a clipping time of 120 minutes with a battery charge of 90-120 minutes. After use, the mower can be easily cleaned, thanks to its detachable mowing head. The design remains unchanged. Speed: 5500 oscillations / min. Autonomy: approx. 120 min. Charging time: 90-120 min. Battery technology: Lithium-Ion. Cutting length : 0,3 mm. Noise emission LpAm: <60 dB(A). Length: 145 mm. Width: 30 mm. Height: 38 mm. **Weight: 120 g.** 24 months warranty. Made in Switzerland.

Sku. 154700050 Battery Li-Ion 

Sku. 154700100 MINI trimming head 





BATTERY STYLE MIDI TRIMMER



This trimmer is used for the part trimming of the dog and the contours of the dog's head, legs, belly and tail. The continuously adjustable cutting head allows variable **cutting lengths between 0.5 - 2.5 mm**. The package also includes 5 snap-on combs in the most common **cutting lengths 4, 8, 12, 16 and 20 mm**. Furthermore, the supplied cable adapter allows trimming any time on the 230V mains. Light with low-noise and precise cut, the new Heinger Style Midi Trimmer glides through the dog's coat with ease. Noise: 63 dB. **Weight: 240 g. Motor speed: 2400 rpm.** Size: 175 x 46 x 50 mm. Operating time: up to 100 minutes.

Sku. 154710	1 batterie	
Sku. 154710100	MIDI trimming head	

Saphir clipper heads



Sku. 100282

 Comb 0,2 mm



Sku. 100283

 Comb 0,25 mm



Sku. 100284

 Comb 0,5 mm



Sku. 100285

 Comb 0,8 mm



Sku. 100286

 Comb 1,2 mm



Sku. 100287

 Comb 1,5 mm



Sku. 100288

 Comb 2 mm



Sku. 100296

 Comb 2,3 mm



Sku. 100289

 Comb 2,8 mm



Sku. 100290

 Comb 3,2 mm



Sku. 100291F

 Comb 3,2 mm



Sku. 100292

 Comb 6,3 mm



Sku. 100293F

 Comb 6,3 mm



Sku. 100294

 Comb 9,5 mm



Sku. 100295F

 Comb 9,5 mm

CURVED BLADE SCISSORS

It is used for the finishing of the mane but also to prepare the animals for the shearing (for dirty or matted parts). They also allow the shearing of small areas before a surgical operation. The curved blade avoids pricking or cutting into the animal skin.



Sku. 100338  3 338020 000920

18 cm

Sku. 100340  3 338020 000944

20 cm

COOL SPRAY FOR COMB **UKAL**

Cooling spray for clippers, combs and blades. This product cools, lubricates and cleans. Therefore it improves shearing and keeps the combs sharp. It prevents dirt accumulation, which optimizes the performance of your shears and ensures perfect hygiene. It is also suitable for hair clippers, beards and electric razors. Clean the combs with a brush or a dust remover spray, then apply the cooling spray.



Sku. 100143  3 700393 914911

500 ml 

SHARPENING PASTE

The very fine grain n°1 sharpening paste is suitable for finishing or cutting heads for dog/ rabbit. Sharpening paste n°2 is suitable for all types of combs and counter combs of Heiniger electric clippers or others. For sharpening bovine, ovine or equine combs. 480 g.



Sku. 100121001  3 338020 000364

Fine grain N°1

Sku. 100121002  3 338020 000371

Coarse grain N°2

VASELINE OIL **UKAL**

The use of oil is needed for proper operation of the clipper.

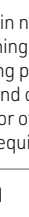
Sku. 100141  3 338020 000630

100 ml



SPECIAL CLIPPER OIL **Heiniger**

Specially developed non toxic clipper oil increases performance, reduces friction and enhances blade life.

Sku. 100142105  7 613073 009745

100 ml 

Sku. 100142102  7 613073 001282

500 ml 





UKAL

—
**VACCINATION
& DRENCHING**

- 118 Demoplast
- 122 Socorex
- 123 NJ Phillips
- 124 Needles

VACCINATION STRATEGY

The link between vaccination strategy and herd size is clearly visible. 80% of farms with more than 100 cows routinely vaccinate in order to ensure good health of the herd without the cost and time taken by other preventative approaches. In smaller herds, vaccination strategies are less homogeneous: 1 out of 2 breeder does not vaccinate, preferring other preventive strategies more easily permitted by herd size.

How to choose the syringe and needle ?

The choice of a syringe (manual, automatic or revolver) depends on the product to be injected, the injection volume, the repetition of gesture or on the urgency of the injection.

The choice of the needle depends on the type of injection (subcutaneous, intramuscular, intravenous) and the product viscosity. There is a sizing convention. For example, a needle 15/10 = 15 mm length / 10 mm in diameter.

- **Subcutaneous injection** : under the skin for slow diffusion due to low blood supply.
- **Intramuscular injection**: in muscle (thigh or neck) for rapid dissemination through the strong blood supply.
- **Intravenous injection**: in the jugular for immediate action. However, please be aware of shocks. You must use this method only in severe cases.

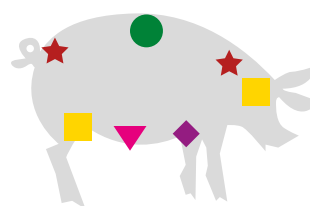
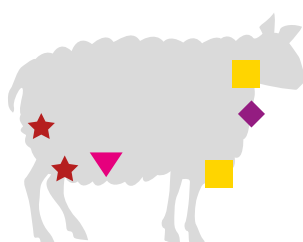
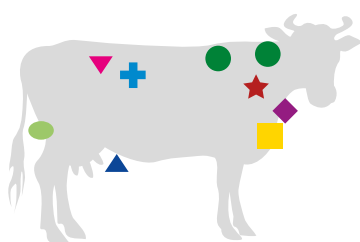

- Subcutaneous
- ★ Intramuscular
- ▼ Intraperitoneal
- ⊕ Intraruminal
- ◆ Intravenous
- Intradermal
- Retromammary
- ▲ Intramammary

Examples of application

BOVINS		
Intramuscular 30/15, 30/20, 40/20	Subcutaneous 15/20, 20/20	Intravenous 60/20
OVINS		
Intramuscular 20/15, 30/15	Subcutaneous 10/10, 15/10	Intravenous 20/15, 30/20
PORCINS		
Intramuscular 30/20, 40/15, 40/20, 50/20 10/18	Subcutaneous 10/10, 15/13, 15/10	Intravenous 40/20

HOW TO CHOOSE THE RIGHT NEEDLE?

INTRAMUSCULAR		SUBCUTANEOUS		INTRAVENOUS	
Piglet	10/10 - 15/10	Lamb	20/10	Sheep	30/20 - 40/20
Sow	40/15 - 50/20	Sheep	20/15	Cattle	60/20
Poultry	10/15	Cattle	20/20 - 25/15 - 30/15	For oily product	Diamètre 15 ou 20
Lamb	15/15				
Sheep	25/20				
Cattle	30/20 - 35/15 - 40/20				



Veterinary quality. DEMAPLAST offers a wide range of products for vaccination (manual, semiautomatic or automatic syringes) and for the drenching (dosing syringes, drenchers). The products are manufactured in Europe. They are known for their quality and their very good value for money.

DEMPLAST PLEXI SYRINGE



Economical syringes. Multi-purpose. Can be boiled or cold sterilized. **Plastic piston, cover and handle.** Wash thoroughly after use. Rinse thoroughly with clean water. Lubricate with vaseline oil Sku. 110039. Replace washers regularly. Do not autoclave. With LUER LOCK fitting.

Sku. 110004005	5 ml tip luer lock Sku. washer: 9DE005		
Sku. 110004010	10 ml tip luer lock Sku. washer: 9DE010		
Sku. 110004020	20 ml tip luer lock Sku. washer: 9DE020		
Sku. 110004030	30 ml tip luer lock Sku. washer: 9DE030		
Sku. 110004050	50 ml tip luer lock Sku. washer: 9DE050		
Sku. 110004100	100 ml tip luer loc Sku. washer: 9DE100		



LUER LOCK

DEMPLAST METAL SYRINGE



Handle and cover made in metal. Can be boiled or sterilized at high temperature. Wash thoroughly after use. Rinse in clear water. Lubricate with vaseline oil Sku. 110039. Replace washers regularly. Do not autoclave. With LUER LOCK fitting.

Sku. 110001005	5 ml - Sku. washer : 9DE005 Limited stock		
Sku. 110001010	10 ml - Sku. washer : 9DE010		
Sku. 110001020	20 ml - Sku. washer : 9DE020		
Sku. 110001030	30 ml - Sku. washer : 9DE030		
Sku. 110001050	50 ml - Sku. washer : 9DE050		



LUER LOCK





PRIMA AUTOMATIC SYRINGE



Professional instrument. Automatic syringe. Body made of nylon and the barrel a specific polymer. Ergonomic handle for a better grip. Precise and reliable dosing thanks to the valve. Supplied with spare part kit.

This model is supplied with vial holder.

Sku. 110040202 

2 ml vial holder 

Sku. 110040205 

5 ml vial holder 

This model is supplied with feeding tube (not pictured).

Sku. 110040101 

1 ml feeding tube 

Sku. 110040102 

2 ml feeding tube 

Sku. 110040105 

5 ml feeding tube 

Sku. 110040110 

10 ml feeding tube 

+ PRODUCTS

- High quality
- Effortless, high throughput vaccination
- From small to large animals
- Suitable for most liquids and suspensions
- Operate under any climatic conditions
- Easy disassembly and maintenance
- All components are treated against corrosion



DRENCHING GUN



Very robust ABS grip and ergonomic handle. Transparent acetate barrel. Resistant to chemical attack. Dose adjustment by screw. Comes with a 125 mm (9AL125) cannula for 35 ml and 70 ml pistols. Original design. Made in Europe.

Sku. 107035 

In acetate - 35 ml 

Sku. 107070 

In acetate - 70 ml 

Sku. 107035A 

Automatic dosing gun 35 ml 

Sku. 107070A 

Automatic dosing gun 70 ml 



DRENCHING GUN



Very robust and ergonomic ABS grip. Transparent acetate or polypropylene barrel. Resistant to chemical stress. Calibration through distal screw. Comes with a 200mm (9AL200) cannula for 200 ml and 300 ml pistol. Made in Europe.

Sku. 107200 

Acetate barrel - 200 ml 

Sku. 107200S 

Drenching gun polypropylene cylinder 200 ml 

Sku. 107300 

Polypropylene transparent barrel 300 ml 

Sku. 107805 

Service kit for drenching gun - 300 ml 



AUTOMATIC DRENCHING GUN BRAVO + HOSE



The valve and the tank are resistant to chemical attack. Dosage adjustment using the wheel behind the barrel. Ergonomic handle. Supplied with nozzle, suction hose, Luer Lock and spare parts (washers). Can be used with tank Sku. 107900 (sold separately).

Sku. 107430 3 338020 055197

30 ml

Sku. 107460 3 338020 055203

60 ml

METAL DRENCHING SYRINGE



Metal piston and handle. Plexi transparent barrel. Complete, delivered with 250 mm cannula (9AL 250).

Sku. 107630 3 338020 002887

300 ml

Sku. 107645 3 700393 927836

450 ml

PLEXI DRENCHING SYRINGE



Drenching syringe. Cellulose acetate. Very resistant to shock and to chemical stress. Delivered with cannula.

Sku. 107755 3 338020 002979

250 ml

CANNULA FOR SYRINGES



To be used with metal and plexi DEMAPLAST syringes.

Sku. 107760 3 338020 002993

LUER LOCK Length: 120 mm

Sku. 107762 3 338020 003013

Male screw Length: 120 mm



LUER LOCK

MALE

TANK SET FOR AUTOMATICS GUNS



1 plastic backpack with 3 liter capacity.

Sku. 107900 3 L 3 338020 053933



INTRAVENOUS SET



Allows perfusion for intravenous treatment. Rehydration fluid, minerals, glucose, etc.

Sku. 110600 Silicone 3 338020 066988

Sku. 110601 PVC 3 700393 971631





SOCOREX is a Swiss brand .They manufacture a wide variety of high precision instruments used for reliably measuring, dosing, transferring, dispensing and injecting liquids in a large number of applications. Each precision instrument bears its own serial number and passes a strict performance control attested by an individual QC certificate. Discover the automatic syringes from SOCOREX.



AUTOMATIC SYRINGE WITH VIAL HOLDER



Most commonly used, the automatic vial feeding syringe is perfectly adapted for injecting aqueous, oily, viscous or heavy iron solutions as well as a variety of suspensions. Enables tight fitting of any 20 mm neck diameter vaccine vial. (needle not included).

Sku. 110050011/5	0,5 ml	3 338020 052615
Sku. 110050011	1 ml	3 338020 049998
Sku. 110050012	2 ml	3 338020 039296
Sku. 110050015	5 ml	3 338020 031443
Sku. 110050020	10 ml	3 338020 051441

AUTOMATIC SYRINGE WITH FEEDING TUBE



Automatic Syringe supplied with aspiration and vent cannulas, sinker and silicone tubing (1 metre), spare part kit and operating instructions (needle not included).

Sku. 110050001/5	0,5 ml	3 338020 052400
Sku. 110050001	1 ml	3 338020 031405
Sku. 110050002	2 ml	3 338020 031412
Sku. 110050005	5 ml	3 338020 031429
Sku. 110050010	10 ml	3 338020 031436



PLASTIC DRENCHING GUN

Metal cannula. Plastic body. Ideal for sheep. Lightweight. Easy to clean. 25 ml.

Sku. 107830



25 ml

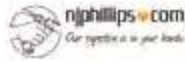

SEMI AUTOMATIC PLASTIC SYRINGE

Comfortable handle. Easy choice of 5 fixed dose settings. Ergonomic fingertip action reduces hand strain.

Sku. 11001050



50 ml

Sku. 11001025



25 ml

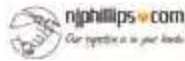

METAL ORAL DRENCHER

Light weight, well balanced, robust design. Easy access to piston and valves for servicing. Simple dose adjustment system. High-flow, blockage resistant valves. Highly chemical resistant cylinder with moulded graduations. Dosage from 1 to 20 ml. Delivered with a sheep cannula. Service kits available.

Sku. 107820020



20 ml

Sku. 107815020



20 ml with backpack
2,5L



SEMI AUTOMATIC METAL SYRINGE

Comfortable handle. Administers a variety of vaccines. Easy to clean and maintain. Fixed settings for ease and speed of use.

Sku. 110013050



50 ml

Sku. 110013025



25 ml

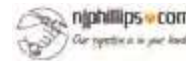

Accessories

VASELINE OIL UKAL

Lubrication of materials and various equipments. Jelly oil is essential for the operation of the syringes and the clipper. Non toxic. Doesn't irritate the skin.

Sku. 110039



50 ml

Sku. 100141



100 ml



WEIGHTBAND KAMER

For an approximate evaluation of the weight in kg of living animals. Not allowed for commercial transactions. Customisation available on request.

Sku. 129040



VACCINATION | Needles



TRIPLE EDGE NEEDLES

Luer Lock hub. Triple edge sharpening ensures better penetration.

Sku. 110180	
L 10 mm Ø 8	Box of 12
Sku. 110190	
L 10 mm Ø 10	Box of 12
Sku. 110190008	
L 8 mm Ø 10	Box of 12
Sku. 110200	
L 15 mm Ø 10	Box of 12
Sku. 110201	
L 20 mm Ø 10	Box of 12
Sku. 110201030	
L 30 mm Ø 10	Box of 12
Sku. 110202040	
L 40 mm Ø 12	Box of 12
Sku. 110205	
L 15 mm Ø 13	Box of 12
Sku. 110205013	
L 13 mm Ø 13	Box of 12
Sku. 110207	
L 15 mm Ø 15	Box of 12
Sku. 110207010	
L 10 mm Ø 15	Box of 12
Sku. 110210	
L 20 mm Ø 13	Box of 12

Sku. 110215	
L 20 mm Ø 15	Box of 12
Sku. 110216	
L 25 mm Ø 15	Box of 12
Sku. 110218	
L 25 mm Ø 20	Box of 12
Sku. 110220	
L 30 mm Ø 13	Box of 12
Sku. 110221	
L 30 mm Ø 15	Box of 12
Sku. 110225	
L 40 mm Ø 15	Box of 12
Sku. 110230	
L 50 mm Ø 15	Box of 12
Sku. 110247	
L 15 mm Ø 20	Box of 12
Sku. 110250	
L 20 mm Ø 20	Box of 12
Sku. 110255	
L 30 mm Ø 20	Box of 12
Sku. 110260	
L 40 mm Ø 20	Box of 12
Sku. 110265	
L 50 mm Ø 20	Box of 12



DELVO VETERINARY NEEDLES

High quality veterinary needles. Triple bevel sharpening. LUER LOCK hub.

Sku. 110300	
L 10 mm Ø 10	Box of 12
Sku. 110301	
L 15 mm Ø 10	Box of 12
Sku. 110305	
L 10 mm Ø 15	Box of 12
Sku. 110307	
L 15 mm Ø 15	Box of 12
Sku. 110315	
L 20 mm Ø 15	Box of 12
Sku. 110321	
L 30 mm Ø 15	Box of 12
Sku. 110347	
L 15 mm Ø 20	Box of 12
Sku. 110350	
L 20 mm Ø 20	Box of 12
Sku. 110355	
L 30 mm Ø 20	Box of 12
Sku. 110360	
L 40 mm Ø 20	Box of 12
Sku. 110365	
L 50 mm Ø 20	Box of 12





UKAL

—
**FARM
AND STABLE
EQUIPMENTS**

- 126 **Drinkers**
- 128 **Feeders & Hay racks**
- 131 **Stable equipment**
- 132 **Cleaning**
- 135 **Shovels**
- 139 **Scales**
- 141 **Thermometers**
- 142 **Hooks**
- 144 **Pest control**



IDEAL DRINKING BOWL MODEL 61 **SUEVIA**

Enameled cast bowl made of cast iron. Smoothly running pipe valve for a calm water flow. 1/2" water supply from the top or the bottom. For pipe or wall mounting. 4-hole fixation. Approximate water flow quantity of 6 l/min (at 5 bar water pressure).

Sku. 119160  4 025338 000245
Cast iron



DRINKING BOWL MODEL 10P **SUEVIA**

High quality plastic drinking bowl. Smoothly running pipe valve for a calm water flow. 1/2" water supply from the top. For pipe or wall mounting. 2-hole fixation. Approximate water flow quantity of 6.5 l/min (at 5 bar water pressure).

Sku. 119170  4 025338 000085
Plastic

FLOATER DRINKING BOWL





Solid plastic bowl and cover. With resistant float valve. 1/2" water supply from on the side. Easy adjustment of water level. Approximate water flow quantity of 10 l/min (at 5 bar water flow).

Sku. 119165  4 014803 346391 
Plastic

DRINKING BOWL WITH PIPE VALVE





Double powder coated bowl made of cast iron. Smoothly running pipe valve for a calm water flow. 1/2" water supply from the top or the bottom. For pipe and wall mounting. 4-hole fixation. Approximate water flow quantity of 12 l/min (at 5 bar water flow).

Sku. 119180  4 014803 301888 
Cast iron

FLOATER DRINKING BOWL XL





Solid plastic bowl and cover. With resistant float valve. 1/2" water supply from on the side. Easy adjustment of water level. Approximate water flow quantity of 10 l/min (at 5 bar water flow).

Sku. 119185  4 014803 343253 
Cast iron

DRINKING BOWL WITH PRESSURE TONGUE



Double powder coated bowl made of cast iron. Exchangeable brass valve. 1/2" water supply from the top or the bottom. For pipe and wall mounting. 4-hole fixation. Approximate water flow quantity of 8-10 l (at 5 bar water flow).

Sku. 119190  4 014803 312006 
Cast iron - stainless steel tongue

Sku. 119195  4 014803 312013 
Cast iron

LIGHT GREEN EPOXY BUCKET

Galvanized + epoxy coating. With spout. Light green.

Sku. 12003013



3 700393 914928

12 L

Limited stock



ALUMINIUM BUCKET

Material : Aluminium. With spout.

Sku. 120003012



3 338020 056392

12 L



GREEN PLASTIC BUCKET

Plastic. Extremely durable and shatterproof due to the high wall thickness. Extra stable handle for everyday use. With inner scal. **Made in Europe.**

Sku. 122016

7 L



4 014803 343802

Sku. 122020

12 L



4 014803 343819

Sku. 122021

17 L



4 014803 343826



**EQUIP YOUR WATERING TROUGHS
WITH OUR HOTLINE MEADOW PUMP.**
An energy-saving solution!



→Go on page 206 to discover our range





UNIVERSAL MANGER WITH GRASP

Made of very high impact resistant polypropylene with rounded edges. With carrying handle 13 liters capacity. Dimension: width x height x depth = 36,5 x 38 x 28 cm. **Made in Europe.**

Sk. 122205008	Green	4 014803 444837
Sk. 122205002	Black	4 014803 444844



FEED BUCKET WITHOUT HANDLE

Plastic with steel attaching hools perfectly adapted for boxes doors. Very resistant. 14 L ≈. Dimensions : 38.1 x 30.5 x 25.4 cm. **Made in Europe.**

Sk. 122202002	Black	4 014803 440273
Sk. 122202006	Blue	4 014803 343222
Sk. 122202008	Green	3 338020 053834



PORTABLE MANGER, 13,5 L

Made of very high impact resistant polypropylene with rounded edges. With mounting brackets and carrying handle **13,5 liters capacity**. Dimension: width x height x depth = 36 x 37 x 31 cm. **Made in Europe.**

Sk. 122203002	Black	4 014803 444806
Sk. 122203006	Turquoise	4 014803 445933
Sk. 122203008	Green	4 014803 445919
Sk. 122203009	Kaki	4 014803 444790
Sk. 122203020	Purple	4 014803 445926

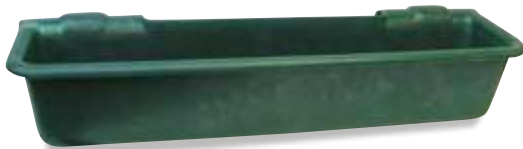

MANGER RECTANGULAR

Made of very high impact resistant polypropylene. Portable. Useable for group housing of calves. **Capacity: 50 liters.**

Sk. 122204200	Green Limited stock	5 703414 120306
----------------------	-------------------------------	-----------------

MANGER WITH HOOK AND HANDLE

Very solid. Perfect for transport. **Approx. 14 liters capacity.** Several colors are available. **Made in Europe.**

Sku. 122206002 

Black

Sku. 122206003 

Red

Sku. 122206006 

Blue

Sku. 122206007 

Light green

Sku. 122206008 

Green

Sku. 122206020 

Purple

Sku. 122206022 

Turquoise



UNIVERSAL MANGER

Made of very high impact resistant polypropylene with rounded edges. **12 liters capacity.** With inner scale 41 x 34 x 35 cm. **Made in Europe.**

Sku. 122207002 

Black

Sku. 122207008 

Green



CALF AND SHEEP FEEDER

Made of very high impact resistant polypropylene with rounded edges. **8,5 liters capacity.** Foal manger insert also fits with this feeder. Dimension: width x height x depth = 35 x 22,5 x 28 cm. **Made in Europe.**

Sku. 122208002 

Black

Sku. 122208008 

Green



FOAL MANGER

With adjustable bars. Made of very high impact resistant polypropylene with rounded edges. **8,5 liters capacity.** Thanks to the adjustable bars only the foal can take up the feed. Easy, quick and flexible adjustment to suit growing animals. Dimension: width x height x depth = 35 x 22,5 x 29 cm. **Made in Europe.**

Sku. 122209002 

Black

Sku. 122209008 

Green



FLEXI-TUBS



Flexible tubs ideal for everyday work in small stables (clearing out stalls, distributing water, grain or hay). Not only sturdy and strong but also flexible and very light. **Capacity: 12 liters.**

Sku. 130E711000002 

Black

Sku. 130E711000003 

Red

Sku. 130E711000006 

Blue



FARM AND STABLE EQUIPMENTS | Baling twine and hay racks



BALING TWINE

Polyethylene baling twine, with loops.

Sk. 130E306823002



Black



BALING TWINE

Polypropylene, with loops.

Sk. 130E306760



Assorted colors



Hay racks



HEAVY DUTY CORNER HAY RACK

Depth: 53 cm. Grill type: 12 mm diameters bars. Height: 83 cm. Width: 53 cm.

Sk. 119400002



83 x 53 x 83 cm

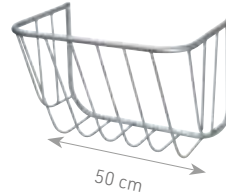

HAY RACK LARGE MODEL

Made from zinc-plated steel. Strong, sturdy model. Available in two sizes.

Sk. 119400003



Big model
70 x 70 x 45 cm



Sk. 119400004



Little model
50 x 35 x 21 cm



HALF-ROUND HAY RACK

Hay rack form: Half-round. Depth: 42 cm. Height: 62 cm. Width: 73 cm. Material: Zinc plated steel.

Sk. 119400005



73 x 62 x 42 cm

Limited stock

Salt lick holder s



SALT LICK HOLDER

The plastic salt lick holder helps to avoid animal dung waste and pollution of mineral supplements. Helps to control the animal salt consumption. For round and square lickstones up to 10 kg. Solid design, plastic. Anti-bite edge. UV-resistant. **Made in Europe.**

Sk. 119300002

Black



Sk. 119300004

Brown
Limited stock



Sk. 119300006

Blue
Limited stock



Sk. 119300008

Green



Sk. 119300021

Purple
Limited stock



SALT LICK HOLDER

For 2kg lickstones. Solid design. Foodsafe. Anti-bite edge. UV-resistant.

Sk. 119300204

Brown
Limited stock



FIXED BRIDLE BRACKET



Traditional bridle bracket, ideal for your tack.

Sku. 130E704200002



Black
Limited stock



BRIDLE BRACKET



Full headpiece support. Metal covered with plastic.

Sku. 130E704204002



Black



VINYL COATED SADDLE RACK

Standard type saddle rack. Ideal for your tack room.

Sku. 130E704220002



Black



REMOVABLE BRIDLE BRACKETS

For outdoor or indoor use. Made of sturdy plastic-coated metal, with one or two fixed bridle brackets and one multi-purpose hook.

Sku. 130E704226002



Black



JUMP CUPS HOLDER

Made of extra-strong ABS plastic with notches for jump cups every 5 cm. Affixes to a wooden post with screws Interlocks with one or several additional holders to increase total height.

Sku. 130E704601005



Jump cup

Sku. 130E704600005



Jump cups holder



GRIP FOLDING STOOL



Stool with anti-slip rubber pimples. Easy to carry thanks to its integrated handle, and can be easily stored away behind a cabinet or inside your locker. Features anti-slip rubber legs. Can hold weights of up to 100kg. Dimensions: L 28.5 x W 21.5 x H 39 cm. Compliant with EN 14183:2003 safety standards.

Sku. 130E930251



Grey



Brooms

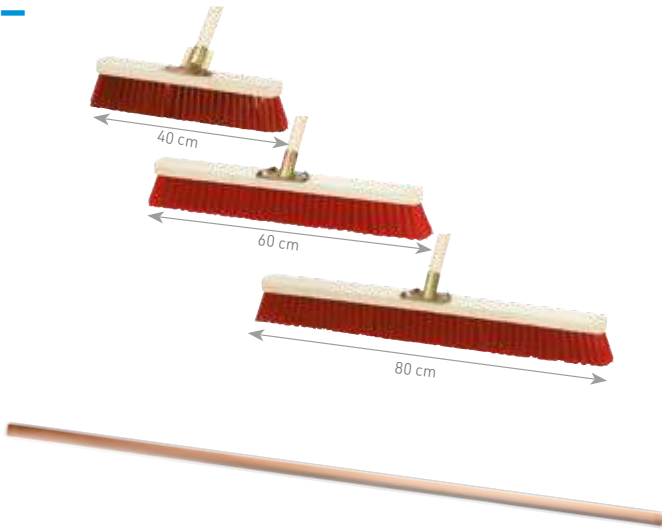

PVC BROOM

Height: 90 mm. Width: 70 mm. Length: 400 mm. Material: PVC. Ideal to use when the ground is rough. For big sweeping jobs (wet or dry). Delivered without handle. Exists in 3 sizes.

Sku. 129300040	40 cm	3 338020 083022	6
Sku. 129300060	60 cm	3 338020 083039	6
Sku. 129300080	80 cm	3 338020 083046	3

WOODEN HANDLE 28 MM

Can be used with Sku. 129300040-060-080, 129312, 129312001. Diameter: 28 mm.

Sku. 129390	Ø 28 mm	3 338020 083091	25
--------------------	---------	-----------------	----



GREEN RANGE BROOMS

A high quality range. Without shaft. Suitable shafts: 129007002 and 129007003.

Sku. 129300100	Scrubbing broom 29 cm	4 250560 516602	10
Sku. 129300120	Universal - 40 cm	4 250560 500298	6
Sku. 129300140	Large - 40 cm	4 250560 514783	10

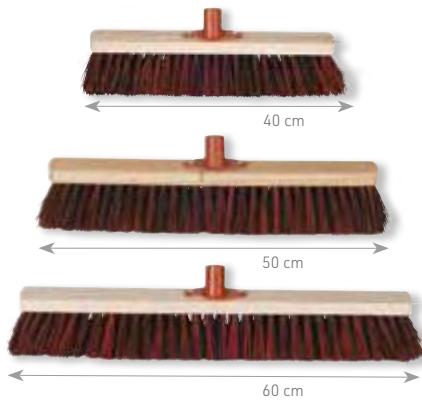

FARMERS BROOM

Plastic shaft holder (24 mm). Dustbinding, moisture resistant and very robust due to Arenga / Elaston bristles. Ideal for high load. Without shaft. Suitable shafts: 129007002 & 129007003.

Sku. 129300160	40 cm	4 250560 509598	10
Sku. 129300180	50 cm	4 250560 509635	10
Sku. 129300200	60 cm	4 250560 509666	10

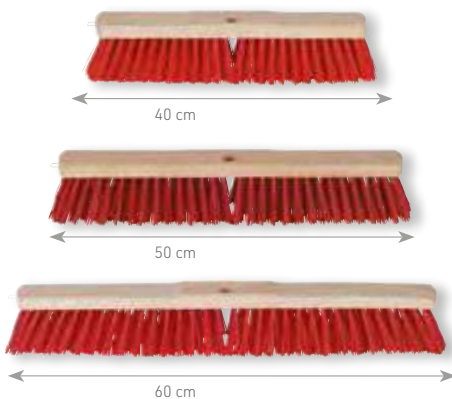

HALL BROOM

With saddle wood and shaft hole (24 mm). With red and moisture resistant PVC bristles. Without shaft. Suitable shafts: 129007002 and 129007003.

Sku. 129300220	40 cm	4 250560 509413	10
Sku. 129300240	50 cm	4 250560 509451	10
Sku. 129300260	60 cm	4 250560 509482	10

PVC ROADMAN BROOM 32 CM

For small sweeping jobs, dry or wet.
Delivered without handle.

Sku. 129310



L 320 mm L 70 mm
H 130 mm / Red



RICE STRAW BROOM

Broom in rice straw. Length of the handle:
94 cm. Width of the broom: 30 cm. Weight
of the broom with handle: 0,7 kg.

Sku. 129312003



Length: 138 cm



Forks

SHAVING FORK "ORIGINAL SWEDISH"

Extrem durable, flexible, virtually unbreakable plastic with a high rate of polycarbonate. Extra angular prongs for easy gathering of shavings and manure. Without shaft. 18 prongs. Fork width approx. 40 cm.

Sku. 129480102

Grey



Sku. 129480106

Blue



Sku. 129480108

Green



Sku. 129480120

Purple



SHAFT FOR SHAVING FORK "ORIGINAL SWEDISH"

Incl. bolts. Approx. Ø 26 mm. 115 cm long. Aluminium with plastic handle.

Sku. 129480112

Grey



Sku. 129480116

Blue



Sku. 129480118

Green



Sku. 129480121

Purple



ALUMINUM HANDLE FOR FORK

Length 123 cm. Without shaft. Suitable shaft: 129480201.

Sku. 129480200



Polycarbonate



SHAVING FORK WITH EXTRA HIGH SIDE PARTS

No lateral falling down of muck. Without shaft. Suitable shaft: 129480201. Solid plastic. 17 prongs. Prong length approx. 35 cm. Fork width approx. 40 cm.

Sku. 129480202



Polycarbonate



ALUMINUM HANDLE FOR FORK

Length 123 cm. For sku. 129480200 and 129480202.

Sku. 129480201



Aluminium





MANURE FORK, 4 TEETH

Fork 4 teeth ideal for manure. With ash handle 135 cm. Height of the teeth: 22 cm. Width of the teeth: 31 cm. Anti-corrosion protection, the fork is laquered.

Sku. 129480600	31 cm silver lacquering	4 002408 411910	
Sku. 129480300	31 cm gold lacquering	4 014803 310675	

HAY FORK, 3 TEETH

Hay fork with 3 teeth and ash handle 135 cm long. Anti-corrosion protection, the fork is laquered. Height and width of the fork head: 30 cm.

Sku. 129480400	30 cm gold lacquering	4 014803 310668	
Sku. 129480500	26 cm silver lacquering	4 014803 310651	

FORKS WITH SPRING SOCKET

Without shaft. 1/2 gold and 1/2 silver lacquered. Suitable shafts: 129007008 and 129007010.

Sku. 129480510	26 x 20 cm 3 teeth	4 014803 310026	
Sku. 129480610	26 x 20 cm 4 teeth	4 014803 310002	
Sku. 129480620	26 x 20 cm 6 teeth	4 014803 310453	



Stablemate

STABLEMATE

Complete set with shovel and rake. Ideal for partial resistant cleaning.

Sku. 129480205	4 014803 341082	
-----------------------	-----------------	-------------------------------------------------------------------------------------

Shovel + rake



Hay rake

HAY RAKE

Solid high quality plastic for a long durability. Approx. 64 cm wide. Delivery without shafts. Suitable shaft: 129007003.

Sku. 129481	5 411069 161000	
--------------------	-----------------	---------------------------------------------------------------------------------------

16 teeth



Scrapers

STRAIGHT SCRAPER

Ideal after washing the floor. Bracket material : Zinc plated. Delivered with 2 rubbers (129006).

Sku. 129005  3 338020 038343

60 cm

Sku. 129006  3 338020 039456

Rubber for straight scraper

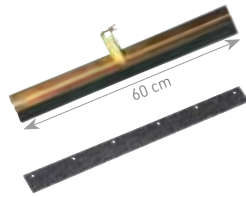

CURVED DUNG SCRAPERS

Rubber band. The rubber band and the handle brace are replaceable. Stick not included. Zinc plated. Spare rubber 55 cm (sku. 129004) and 75 cm (sku. 129002).

Sku. 129001  3 338020 035021

75 cm

Sku. 129003  3 338020 036714

55 cm



SMP DUNG SCRAPER

Ejection squeegee, reinforced model. Use for the maintenance of waiting areas, curtains. Galvanized. Delivered without sleeve.

Sku. 129008  3 338020 077106

75 cm

Sku. 129009  3 338020 077120

55 cm

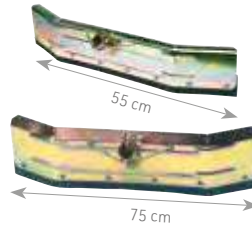

PULL SCRAPER

Green, lacquered steel. Useful for keeping holding areas and sawdust covered grounds clean. Stick not included.

Sku. 129009100  3 338020 085682

35 cm



Squeegee

STAINLESS STEEL FLOOR SQUEEGEE

Removes all chaff and dust without lifting. The soil dries out faster. Lightweight and easy to wash.

Sku. 129271 44 cm  5 410616 144411  40

Sku. 129272 60 cm  5 410616 145913  12

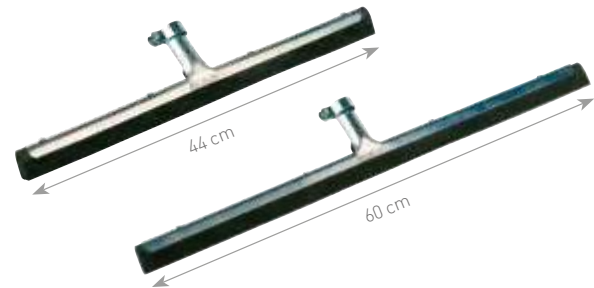

Shovels

FLAT ALUMINIUM SCOOP

KAMER

Flat feeding scoop in aluminium. Sustainable quality.

Sku. 129010001 1 kg  4 014803 301369  50

Sku. 129010002 1,6 kg  4 014803 301376  40

Sku. 129010005 2,5 kg  3 700393 923906  20





ROUND ALUMINIUM SCOOP

KAMER

Thanks to this high-quality aluminum round loading shovel, you can easily feed your animals. Its aluminum construction offers an incomparable resistance as well as a lightness that you will appreciate!

Sku. 129010003	0,750 kg	4 	 50
Sku. 129010004	1,6 kg	4 	 18
Sku. 129010006	2,5 kg	3 	 40



SCOOP IN GALVANIZED SHEET METAL

KAMER

Plastic sleeve.

Sku. 129010100	
-----------------------	-----------------------------------------------------------------------------------

Small model 1,5 L

Sku. 129010150	
-----------------------	-----------------------------------------------------------------------------------

Middle model 2 L



PLASTIC FEED SCOOP

Small feed plastic scoop. Non-toxic. White.

Sku. 129012	1 L	3 
Sku. 129012015	1,5 L	3 
Sku. 129012020	2 L	3 

ALUMINIUM SHOVEL

Material thickness: 2 mm. Suitable shafts 129007004, 129007006 and 129007007.

Sku. 129015400	With handle 38 x 38 cm	4 	 5
Sku. 129015500	Without handle 34 x 33 cm	4 	 5



ALUMINIUM GRAINS SHOVEL

KAMER

Ideal for grain. Supplied with handle.

Sku. 129015	
--------------------	-------------------------------------------------------------------------------------

Manche 1,30 m



FEEDING CUP

 **horizont**

Easy measuring of feed quantity with inner scale. Food safe polypropylene. Shatter-proof premium plastic. Perfect for bagged feed - the short handle avoids cracks. Red.

Sku. 129016	
--------------------	---------------------------------------------------------------------------------------

1,5 L





WOODEN HANDLE FOR SCRAPERS

Sku. 129007001 1,30 m  



SHAFT FOR BROOM



Sku. 129007002 1400 x 24 mm  

SHAFT FOR SCRAPERS



Sku. 129007003 1500 x 28 mm  

SHAFT FOR SHOVEL



Sku. 129007004 1300 x 41 mm  

Sku. 129007005 1300 x 32 mm  

SHAFT WITH T-HANDLE

Sku. 129007006 1100 x 41 mm  

SHAFT WITH T-HANDLE

Sku. 129007007 1300 x 41 mm  

SHAFT FOR CURVED FORKS

Sku. 129007008 1350 x 36 mm  

SHAFT WITH METAL NOSE

Sku. 129007009 1350 x 36 mm  

SHAFT CURVED WITH T-HANDLE

Sku. 129007010 1350 x 36 mm  

SHAFT FOR SQUEEGEE

Sku. 129007011 1200 x 36 mm  

SHAFT

Sku. 129007012 1700 x 32 mm  

SHAFT

Sku. 129007013 1800 x 40 mm  



Sprayers



MULTI-USE SPRAYER KAMER

Adjustable jet with brass nozzle. Anatomical shape, shockproof.

Sku. 123400 

By unit



SPRAYER WITH QUICK CONNECT Gilmour

Ideal for spraying hot or cold water. Metal head insert for maximum resistance to hot water. Male hose threaded front for attaching accessories. Metal valve stem and adjusting nut. Rubber head guard protects threads. Flow control adjusts water flow. Hold-open clip for continuous spraying. Insulated handle.

Sku. 123600 

By unit



Cleaning products



CRESYL® BACTERICIDAL DISINFECTANT FUNGICIDE

CRESYL is an effective disinfectant based on phenolic oil and cresol oil. The product is ideal to clean and for disinfecting cattle barns, rabbit hutches, hen houses and all transport equipment. The dilution rates is 3% (3 liters of Cresyl for 100L of water).

Sku. 000601001 1 L  

Sku. 000601005 1,5 L  

Find the complete range of EKO'PIN multi-use cleaners on the website www.ekopin.fr, in the UKAL GREEN catalog p.5 and on the UKAL webshop. French market only, ask us if you need information.

Scales

CATTLE COUNTER KAMER

For an evaluation of the number of living animals. 4 rows. Metal. Manual.

Sk. 129041



Metal



DIGITAL CRANE SCALE KAMER

Not allowed for commercial transactions. New model with more advanced electronics. Versatile, reliable, accurate and easy to use. New large LCD display for better visibility (visual distance over 10 m). Removable hook.

Sk. 129051200



200 kg



200
KG

KITCHEN SCALE KAMER

Kitchen scale, **not allowed for commercial transactions.** High precision sensor system- Large LCD backlit display. Different weighing units (kg, lb, b / oz) - External calibrationtare function- Capacity: 150 kg. Low battery and overload indication- Remote display (on the wall, desk ...). Allows weighing large packages without hiding the display. Stainless steel platform. Power: 1,5 V x 4 AA battery or 110 V adapter (included). Does not stop automatically. Built-in clock (press the ON / TIME button to see the time). Minimum weight: 300 g. Graduation by 50 g.

Sk. 129052150



150 kg



FIRST ELECTRONIC SCALE KAMER

Not allowed for commercial transactions. This Kamer First electronic load cell is ideal for making a precise weighing up to 30 %. 25 kg. Its digital screen, you will get an easy & amp. Read and you will be sure never to make any mistakes. This electronics is a remarkable precision, Its graduation of 10 g. The weight can be measured in kg or in pounds. This electronic load cell has a very handy ergonomic handhold that allows you to hold it firmly when weighing.

Sk. 129051025



25 kg graduation: 20 g



Sk. 129051050



50 kg graduation: 20 g



Sk. 129051100



100 kg graduation: 20 g



Sk. 129051150



150 kg graduation: 20 g



FARM AND STABLE EQUIPMENTS | Scales



DIGITAL SCALE

KAMER

Peson KAMER Digital display Color Assorted Prohibited for commercial transactions. The new KAMER crane scale is robust, precise and highly reliable. The large and bright led display allows easy reading. Shockproof and vibration resistant construction makes the weighting fast and stable. Raising, weighting, and registering data are done at once. Your best partner for construction, agriculture, warehouse, factory, dock or storage. Not for commercial use. The 1000 kg scale is delivered with a **remote control**.





Sku. 129053030	300 kg graduation: 100 g	3 700393 940040	
Sku. 129053100	1000 kg graduation: 500 g	3 700393 909467	



STANDARD SPRING SCALES

KAMER

Not allowed for commercial transactions.

Sku. 129055010	Graduation pre- cision: 50 g/kilos number: 10 kg	3 338020 043521	
Sku. 129055025	Graduation pre- cision: 100 g/kilos number: 25 kg	3 338020 043538	
Sku. 129055050	Graduation pre- cision: 250 g/kilos number: 50 kg	3 338020 043545	
Sku. 129055100	Graduation pre- cision: 500 g/kilos number: 100 kg	3 338020 043552	
Sku. 129055250	Graduation pre- cision: 1000 g/kilos number: 250 kg	3 338020 043569	





RAIN GAUGE

The rain gauge must be placed in an open area and inserted in the ground vertically.

Sku. 129030	
Rain gauge	



MAXI MINI DIGITAL THERMOMETER DUAL DISPLAY

Instructions The MAX-MIN thermometer simply records the maximum and minimum temperatures obtained during a period. Fix the thermometer in a vertical position, away from heat and direct sunlight. Press «C/F» to select the measurement unit. Specifications: Digital display: MAX/MIN temperature recorded -40+50°C / -40+120°F. Plastic body. Protection roof. AAA battery.

Sku. 129021250	
White	



WALL THERMOMETER

Sku. 129023	
15 cm	
Sku. 129025002	
25 cm	
Sku. 129022	
40 cm	

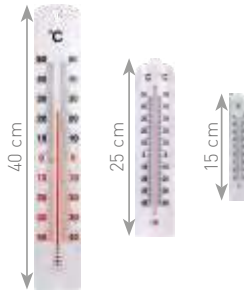

MINI MAXI THERMOMETER HYGROMETER

Indoor or outdoor thermometer with digital display of temperatures. Temperature °C / °F. With mini-max. Wall hook.

Sku. 129021200	
White	

Sku. 129021208	
Green	



DIGITAL THERMOMETER EXTRA LONG PROBE WITH HANDLE

Digital thermometer extra long probe with handle, special for tanks, hay, cheese, ground, temperature control in inaccessible areas. Stainless steel probe # 340 suitable for food contact. Characteristics: Fixed probe very long : 1,45m. -50°C to +200°C / -58°F to +392°F. Resolution: 0,1°. Accuracy: ±1°C / ±2°F. Big digit. Stainless steel probe # 340 (suitable for food contact: 1450 mm - Å 10 mm. Tip Protection. 1 battery LR03 AAA.

Sku. 129021560	Height: 145 cm	
-----------------------	----------------	--



TRIGGER HOOK, ROUND ROTATING

Round Nickel-plated steel. By pair.



Sk. 130700500  3 338020 012633

Round - 20 mm 

Sk. 130700521  3 338020 012640

Round - 30 mm 

Sk. 130700530  3 338020 012657

Square - 20 mm 

CARABINER, 29 MM

By unit.



Sk. 130700535  3 700393 916977

29 mm 

SNAP HOOK OF PANIC, FIXED ROUND EYE

By unit.



Sk. 130700536  3 338020 052967

20 mm 

Sk. 130700537  3 338020 052974

25 mm 

PANIC HOOK

By unit.



Sk. 130E702537  3 338025 099288

Galvanised - 25 mm 

Sk. 130E702537010  3 338025 165334

Brass - 25 mm 

D RING UNIVERSAL TRIGGER HOOK

D-ring 3". By unit..



Sk. 130700547  3 338020 063307

12 cm / 5 inches 

TRIGGER HOOK, ROUND ROTATING RECTANGULAR

By unit.



Sk. 130700531  3 700393 922596

Nickel-plated iron 

TRIGGER HOOK, ROUND ROTATING OVAL

By unit.



Sk. 130700532  3 700393 922602

Oval - 20 mm - Nickel-plated iron 

TRIGGER HOOK, ROUND ROTATING OVAL

By 10.



Sk. 130700533  3 700393 922626

Galvanized  

SWIVEL EYE HOOK

By unit.



Sk. 130E702500  3 338025 099257

Galvanised - 20 mm 

Sk. 130E702521  3 338025 099264

Galvanised - 30 mm 

Sk. 130E702521010  3 338025 099226

Brass - 30 mm 

SWIVEL

By unit. Galvanised steel.



Sk. 130E702539  3 338025 107457

25 x 25 mm **Limited stock** 

SWIVEL HOOK

Nickel-plated steel. By pair.



Sk. 130700539  3 338020 012701

22 x 22 mm 

SNAP HOOK

Galvanized.

Sku. 130700548  3 700393 923418

50 x 5 mm - By 5 

Sku. 130700549  3 700393 923425

50 x 5 mm - By 10 

Sku. 130700550  3 700393 923562

60 x 6 mm - By 5 

Sku. 130700552  3 700393 923395

60 x 6 mm - By 10 

Sku. 130700553  3 700393 923449

70 x 7 mm - By 5 

Sku. 130700554  3 700393 923432

70 x 7 mm - By 10 

Sku. 130700555  3 700393 923456

80 x 8 mm - By 5 

Sku. 130700556  3 700393 923463

80 x 8 mm - By 10 

Sku. 130700557  3 700393 923470

90 x 9 mm - By 3 

Sku. 130700558  3 700393 923524

90 x 9 mm By 10 

Sku. 130700559  3 700393 923494

10 x 10 mm - By 3 

Sku. 130700562  3 700393 923500

120 x 11 mm - By 3 



QUICK LINK

Galvanized. By unit.

Sku. 130700563 5 cm  3 338020 065882 

Sku. 130700564 6 cm  3 338020 065899 

Sku. 130700565 7 cm  3 338020 065905 

Sku. 130700566 8 cm  3 338020 065912 

Sku. 130700567 10 cm  3 700393 922671  



ATTACHMENT RING TO SCREW

With ring to screwing. Galvanized steel. Plate: 50 mm x 50 mm x 4 mm. Ring: Inside diameter: 50 mm. Thickness: 8 mm. By unit.

Sku. 130700620  3 338020 053001

5 cm 



TRIGGER HOOK PLATE

For example, to attach a bucket to a wall. 5 cm. Galvanized. By unit.

Sku. 130700675  3 338020 052981

5 cm 



TIE RING

In galvanised steel. By unit.

Sku. 130E704120  3 338025 072342

1 x 1 cm 
Limited stock





RECHARGEABLE FLASHLIGHT EXPLORER **Hotline** Electric Fencing LARGE MODEL

EXPLORER flashlight: the multi-function accessory to have at home! Long autonomy: about 15 hours. Custom lighting with **4 lighting levels**: low, high, flashing and work light. Practical: easy USB charging and nomadic. Easily transportable thanks to its ergonomic handle. Dual-beam LED torch with flexible housing. 10 watt high-power LED Supplied with a mains charger and a belt. 1 year warranty.

Sku. 126120	Large model Limited stock	5 021385 009803	8
--------------------	------------------------------	-----------------	---



SPECIAL ADHESIVE TAPE FOR FILMS

For repairing damaged films (for example round bales, square bales and flat films). 10 cm wide and 10 m long. Extremely high adhesive power. Highly UV-resistant. Useful also on wet films.

Sku. 129280001	White	4 250574 101313	40
Sku. 129280002	Black	4 250574 101320	40
Sku. 129280008	Green	4 250574 101337	40



Pest control

TRADITION INSECTS KILLER



Stainless aluminium housing. Highly attractive ultra-violet neon strip lights. Insect collection tray. **Designed for indoor use only.** Can be used in all types of professional and domestic buildings: processing facilities, dairies and livestock buildings, etc. Night and day protection against: flies, horseflies, midges, mosquitoes. Insects are attracted to the light source and electrocuted before falling into the collection tray.

USP: Chemical-free, low-energy system. **SAFETY GLASS!** The insect killer contains a powerful ultraviolet neon strip light that attracts mosquitoes and other insects.

Sku. 129503015	15 W - 80m ² 50 x 26 x 8 cm	3 338020 082544	6
Sku. 129503030	30 W - 120m ² 50 x 26 x 8 cm	3 338020 082551	6
Sku. 129503040	40 W - 140 m ² 65 x 36 x 8 cm	3 338020 082568	4
Sku. 129503060	60 W - 160m ² 65 x 36 x 8 cm	3 700393 903557	4



"INSECT O KILL" INSECTS KILLER



The ultraviolet light emitted lures insects into the device's active zone. A high-voltage current flows through the grid in front of the fluorescent tubes. On contact with the grid, the insects are killed instantly and hygienically. The collection tray is easily removed and emptied. With hanging system. 220-240V/50-60Hz. Particularly suitable for agriculture, hotels, restaurants, shops (butchers', bakers', supermarkets), office spaces, as well as all food processing plants and the private sector.

USP: Designed for indoor use.

Sku. 129504016	16 W (2 x 8 W) - 100 m ² - 35 x 10 x 27 cm	4 014803 343383	
Sku. 129504030	30 W (2 x 15 W) - 120m ² - 51 x 10,5 x 31,5 cm	4 014803 441447	
Sku. 129504040	40 W (2 x 20 W) - 140m ² - 66,5 x 10,5 x 37 cm	4 014803 441454	



INSECTS KILLER IPX 4 360°



The new generation of insect killers. This insect killer uses ultraviolet light, which attracts flying insects to the active area of the device. The UV tubes are protected by a plastic film that makes the glass more resistant. It keeps the glass in place if the tube is broken. There is an electrified grid in front of the light tubes. When an insect comes into contact with this grid, it is immediately and hygienically killed. It drops into the collection tray. **The insect killer is class IPX4**. It is therefore splash-proof and rain-proof. A real plus to protect you from insects! **360° opening for a better insect attraction zone.** This means insects are attracted across a wider area. This insect killer's 360° attraction power is a real bonus! The device is environmentally friendly as it uses no toxic products. For indoor or outdoor use. For use in the home, restaurants, farms, stables or even on a large patio. Comes with a hanging system. 3 models are available; 16W, 30W and 40W, with a respective coverage of 100 m², 120 m² and 140 m².

USP : 360° opening-Outdoor use.

Sku. 129507016	Insects killer 16 W 100m ²	3 700393 920677	
Sku. 129507030	Insects killer 30 W 120m ²	3 700393 920707	
Sku. 129507040	Insects killer 40 W 140m ²	3 700393 920714	



DISCOVER THE VIDEO
PRESENTATION OF THE
INSECTS KILLER IPX
4
360°



Fly control



NEW

FLY BUCKET

Reduces fly nuisance on the farm and around the house with up to 90% • traps many flies before emptying is necessary • easy to clean The Fly Bucket 12 L is an ideal product to trap stable flies and house flies. This is how it works: Empty the bag with 240 grams of insect attractant (bag is included). We advise wearing gloves for this. Add 6 litres of water, and let the insect attractant mix well. Close of the bucket with the lid. When the day turns into night and flies search for a sleeping place, they are drawn to the buckets by the attractant and will enter through one of the six special cones. Once inside the bucket, the insect is not able to get back out. The product is active for 30 to 60 days. When it is no longer working or if the bucket is full of flies, it is possible to scoop out the content and start again. The product has a volume of 12 litres and is easy to clean and re-use when it has filled up with flies.

Sku. 129595	Complete Fly busters bucket	3 700393 924453
Sku. 129595001	Filling fly bucket	3 700393 924460



FLY PROTECTION TAPE REEL

Classic and effective product. Flies are attracted with a natural bait. Pack of 4.

Sku. 129562	Fly protection sticky tape reel	4 260059 616508	24
--------------------	---------------------------------	-----------------	----



STICKY FLY TAPES

Sticky fly tapes 7 m or 9 m in length, free of chemical residue or powder. Thanks to its strong, instant attractiveness, the Sticky fly trap is a formidably effective way of trapping all the flying insects that touch it. It is thanks to its patterns that the Sticky fly tape is so effective. Its 30 cm width provides a large surface area that flies can easily land on. The Sticky fly tape can be hung virtually anywhere thanks to its metal hanger.

Sku. 129640007	7 m - Sold singly	3 700393 938030	12
Sku. 129640009	9 m - Sold singly	3 700393 937910	24



STICKY FLY STRING KIT



This complete anti-fly kit is the perfect way to get rid of flies quickly and for good! With its 300-metre long sticky fly string, you will maximise your chances of capture! The kit also includes an unwinder so that you can simply and quickly unwind your string for installation in seconds. This anti-fly string is for use in all types of locations, such as livestock buildings, chicken coops, barns or even warehouses. It is recommended that the string only be used indoors to avoid trapping small birds.

With string

Sku. 129633	Kit with 300 m string	
Sku. 129634	String refill 300 m	



STICKY FLY RIBBON KIT



This complete anti-fly kit is the perfect way to get rid of flies quickly and for good! With its 400-metre long, 0.5 cm wide ribbon, which is sticky on both sides, you will maximise your chances of capture! The kit also includes an unwinder so that you can simply and quickly unwind your ribbon for installation in seconds. Complete sticky ribbon kit designed to trap flies in all types of locations, such as livestock buildings, chicken coops, barns or even warehouses. It is recommended that the ribbon only be used indoors to avoid trapping small birds.

With ribbon

Sku. 129635	Kit with 400 m ribbon	
Sku. 129636	Refill with 400 m ribbon	



Hunting

PINE TAR FOR HUNTERS

ULRICH

"Hunters' special" pine tar in a 5 kg canister. Its powerful odour is very effective in attracting wild boar so that they can be confined and fed. So-called Norway hunters' pine tar is produced by the carbonisation of pine wood. For application to trees. More attractive. Stronger. Made in France.

High quality

Sku. 000026

5 kg



BEECH TAR FOR HUNTERS

ULRICH

Used to confine wild boar to a given territory. The ideal complement to crude tar. Easy to spread as it is less viscous than the hunters' special pine tar. Excellent value for money.

Sku. 000027

5 kg



Traps for licensed trappers

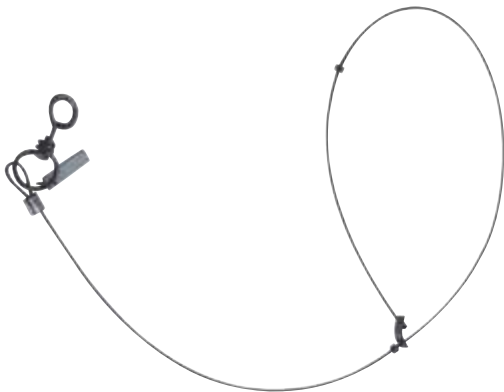

SNARES

For foxes only. The very flexible wire and its irremovable slide are indispensable to facilitate capture. This snare has a latest-generation anti-return feature which prevents the snare re-opening once it is closed. It also has an end stop. The very thick cross-section of its swivel ensures solidity after capture. The stop (crimped) on the wires is crushed steel and not aluminium (non-shiny at night). The snare has a tag to engrave the trapper's number. Ideal for capturing foxes.

Sku. 129704100	10 white snares / Ø 1,6 mm	3 700393 938450	
Sku. 129704101	10 black snares / Ø 1,6 mm	3 700393 938467	
Sku. 129704201	10 black snares / Ø 2 mm	3 700393 938481	
Sku. 129704202	10 white snares / Ø 2mm	3 700393 928758	
Sku. 129704300	10 white snares / Ø 2,3 mm	3 700393 938498	



BAITED FOOTHOLD TRAP

Baited foothold trap, sometimes called a kill trap, 30 cm in diameter, ideal to capture foxes and beech martens quickly and easily. Simply place the bait of your choice in the trap, set it and wait for the pest to be caught. Sturdily made and painted by cathaphoresis to limit rusting and reduce the odour of human beings. This is an ideal trap to rid a roof space of beech martens or protect a chicken run from foxes or martens. It is easily set and you'd be surprised at how effective it is. Use this baited trap to capture pests like beech martens and foxes with ease! The mechanical parts are laser cut for greater stability and reliability.

Approval no. PHE 608

Sku. 129700009	30 cm	3 338020 082483	
-----------------------	-------	-----------------	--



EGG BAIT FOOTHOLD TRAP FOR BEECH MARTENS

Category II trap. For capturing beech martens in particular. Designed to be set up indoors (hen house, barn, roof space) or outdoors, where it will be covered with straw or leaves to make it look like a nest. This type of trap is triggered when the animal removes the bait. It features a safety device, which it is preferable not to forget to use. The mechanical parts are laser cut for greater stability and reliability.

Approval no. PHE 609-610

Sku. 129700010	25 cm	3 338020 078288	
Sku. 129700011	30 cm	3 338020 081714	



WIRE TRAP

Wire trap Ø 13 cm or 17 cm, ideal to capture mice or rats. Very easy to use. Simply place bait on the trigger and open the wire trap to set it. Once set, it should be circular in shape. When the animal takes the bait, the trap closes to capture it.

USP: Works for mice and rats References.

Sku. 129701113	13 cm Limited stock	3 338020 089765	
Sku. 129701117	17 cm Limited stock	3 338020 081752	

BELISLE TRAP

The Belisle is commonly used to capture foxes. This trap allows the pest to be caught safely thanks to the lace that tightens when it places its paw in the trap. Safety device and setting wedge included in the trap..

Approval no. PHE 804

Sku. 129700020	Sold singly		
Sku. 129700022	Spare wire		



FRENCH-STYLE LEGHOLD TRAP

Category IV trap: permit required. Traps must be checked within two hours of sunrise. The French-style leghold trap is a trap with a large trigger plate which improves the capture rate, and wide, hard-rubber lined jaws for a good grip of the leg. For use only by licensed trappers. Supplied with a lace. Trigger sensitivity adjusted by a Teflon screw and washer. The mechanical parts are laser cut for greater stability and reliability.

Approval no. PHE 819

Sku. 129700025	Sold singly		
Sku. 129700022	Spare wire		



CONIBEAR TRAP

The conibear trap is compact and easy to transport. It has a powerful spring as well as a multi-position trigger. The sensitivity of the trap is adjusted by changing dog notches. Consists of a rigid, hand-riveted frame. You will be surprised by the quality of manufacturing of the device. Is used with bait placed on the trigger or in the cage, which directs the animal and increases the chance of capture. Its use is prohibited on regular animal paths. It is very effective in a small garden, in bales of straw or burrows. As it is not selective, it is prohibited in areas where multiple animals pass through.



Approval no. PHE G664

Sku. 129701002	1 trap with 2 springs - 13 cm		
Sku. 129701003	1 trap - 18 cm		



SAFETY SYSTEM FOR CONIBEAR TRAPS

This safety system is specially designed to safely set conibear traps of all sizes. Don't risk injury any longer and set your traps in just seconds with this safe system. Can be used on all conibear traps.

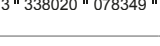
Sku. 129701020	Setting tool for conibear traps - Sold singly		
Sku. 129701021	Simple setting key for conibear traps - Sold singly		



Gas cannon



VERBRUGGE GAS CANNON BIRD SCARER



Device with double gas injection and a housing protecting the mechanism. Protects an area of 1 to 4 hectares depending on the terrain and vegetation. Piezoelectric ignition system for about 200,000 detonations. Interval regulator to set detonations at intervals of from 30 seconds to 30 minutes as required. Propane fuel only. One bottle provides approximately 25,000 detonations. Can be fitted with a timer for more flexible use of the gas cannon.

Tips: Ideal for protecting field crops during sowing and before harvesting (maize, peas, sunflowers, cereals, vines, etc.). Scares away birds and protects your fruit crop.

Sku. 129703600 Quatz gas cannon 

Birds and pigeons



MAGPIE AND CROW TRAP



Formidably effective and operational as soon as it is installed. Can be used in particular to capture decoy birds for magpie or crow cage traps. Simply bait according to the species you wish to catch with eggs, seeds, bread, fruit, etc. The bird is trapped when it comes to take the bait: it is not injured or killed and can be released if necessary. Do not use meat as bait.

Sku. 129703011 Small model 42 x 42 cm 

Sku. 129703010 Large model on a post 75 x 80 cm 

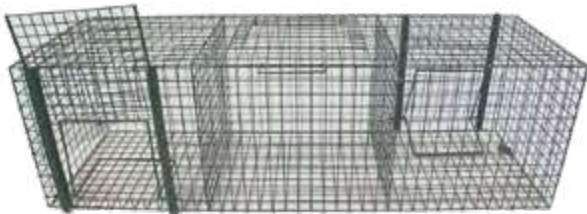

CROW CAGE TRAP WITH PERCH



Size suited to corvidae. The entry doors are oversized, making it particularly effective. Supplied with perch and central decoy bird compartment. 3 compartments.

Tips: It is the responsibility of the consumer to comply with applicable regional or national legislation relating to the use of these products and to trappable species.

Sku. 129703030 92 x 31 x 31 cm 



OCTAGONAL MAGPIE CAGE TRAP



This very effective trap is used with a central decoy bird that attracts other birds of the same species. **4 entries around the periphery.** Hatches close with a tilting perch system. Allows the bird to fly around the trap to find the entrance. The octagonal shape guides the magpie towards the entrance which is most visible to the bird (prevents the bird flying round without entering the trap). Entirely powder coated. Welded wire mesh. Wire thickness 1.8 mm. Also suitable for crows.

Tips: Place your cages in an open space, avoiding trees. Look after your decoy bird (water + food) because it is essential for this trap to work. If you have no luck with your decoy bird, don't hesitate to replace it. In the Haut-Rhin region of France a Prefectoral order dated 27 June 2017 removed the Eurasian magpie from list of species classified as harmful (List II).

Sku. 129703002 30,5 x 100 x 88 cm 

5-ENTRIES ROUND CAGE TRAP



drop-down doors around the edge of the trap. **5 entries around the periphery**, with doors triggered by a tilting perch system. This cage will capture large numbers of birds, especially in spring, the period of reproduction and birth. Ø: 80 cm. Height: 32 cm.

Sku. **129703001** 32 x 80 cm  3 338020 078417

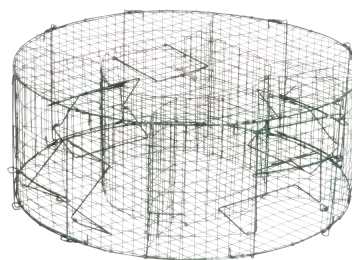

Traps

RABBITS TRAP



This trap can be useful if you need to catch rabbits in one place to release them in another. Even used alone, you will get good results because the tilting door requires no surveillance. Once inside, the animal cannot go back out as the door closes behind it. The rabbit is caught alive and unhurt. It can be released elsewhere. Length: 81 cm. Ø: 13 cm.

Tips: It is the responsibility of the consumer to comply with applicable regional or national legislation relating to the use of these products and to trappable species.

Sku. **129704001** Ø 13 x 81 cm  3 338020 078424

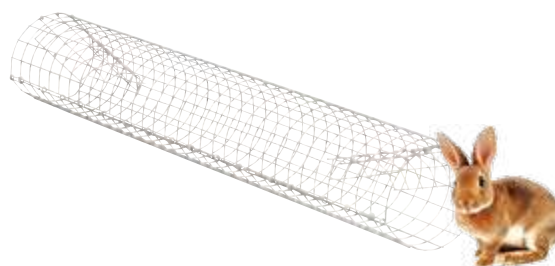

WEASEL BOX



This trap does not necessarily need to be baited, as the animal will generally enter out of curiosity. This type of trap is harmless and effective. It can be placed anywhere (woodpile, barn, chicken coop, etc.). It is a very selective trap: it only lets in the smallest animals. The system is simple: when the animal enters the trap, the trigger plate tips forward, the anti-return system activates and prevents the trigger plate tipping back again, ensuring the animal is a prisoner in the cage.

Tips: Soak the box with a scented liquid bait. This will make the trap more attractive and increase the number of catches. The entrance of the box must not be raised off the ground, but level with it.

Sku. **129704003** 49 x 6 x 8 cm  3 338020 078431



2-ENTRIES CAGE TRAP WITH SLIDING DOORS



Category 1 trap. This 64, 103 or 130 cm long cage trap is ideal for capturing foxes (103 and 130 cm), beech martens, rats and any other mustelids. It has 2 doors and is ideally placed on a path frequented by the pest. The animal will walk through it and be captured when it steps on the ultra-sensitive trigger plate. Make sure you block up any other passages so that the animal is forced to walk through the trap. Scented bait is recommended. Includes a carrying handle. The cage trap can also be used with just one door open, by placing some bait at the far end of the cage. Very effective and totally harmless, it can be used anywhere (woodpile, barn, chicken coop).

Tips: It is the responsibility of the consumer to comply with applicable regional or national legislation relating to the use of these products and to trappable species.

Sku. **12970222020** 64 x 21 x 21 cm  3 338020 078363

Sku. **12970223530** 103 x 31 x 31 cm  3 338020 078387

Sku. **12970224535** 130 x 36 x 47 cm  3 338020 078394





CAGE TRAP WITH SLIDE - RAT TRAP

This compact, easily handled cage trap is ideal for capturing rats. Its 19 x 19 mm mesh is perfect to ensure the animal is not injured and cannot escape once captured. Sturdily made, it will resist any weather thanks to its green epoxy paint finish. It will also blend into any environment with no difficulty. Available in versions with 1 or 2 doors. Lightweight and easy to transport thanks to its integrated handle, you can take this trap anywhere. With it you can trap easily, quickly and for a long time to come!

Sku. 129701502020	1 door - 50 x 20 x 20 cm	3 700393 963315
Sku. 129702502020	2 doors - 50 x 20 x 20 cm	3 700393 963322



SINGLE-ENTRY CAGE TRAP WITH SLIDING DOOR

62, 82 or 127 cm long cage trap, ideal for capturing rats and beech and pine martens. It has one entrance with a drop-down door. Robust, but lightweight, this trap is easy to transport with its integrated carrying handle. The trigger plate at the end of the trap is ultra-sensitive, which ensures that the animal cannot get out again once the door has dropped. The 127 cm cage has a compartment for live bait. Irresistible to predators. This cage trap features a fast-closing sliding door, for safe and easy manipulation of the trap. Very effective and totally harmless, it can be used anywhere (woodpile, barn, chicken coop).

Sku. 1297021254535	127 x 36 x 47 cm	3 338020 081769
Sku. 12970213030	82 x 32 x 31 cm	3 338020 078356
Sku. 1297021602020	62 x 21 x 21 cm	3 338020 080021



2-ENTRIES CAGE TRAP WITH INVISIBLE DOORS

Cage trap with a revolutionary setting system designed in the USA that makes the doors virtually invisible to the animal, thereby increasing the chances of catching the fox, marten or any other animal of a similar size. This trap has 2 doors and is ideally placed on a path known to be used by the pest. Simple to use, this cage trap can be set in seconds. It is easily transported thanks to its carrying handle. It is robust and of superior quality. The wild animal cage trap's steel doors are coated with green epoxy paint.

Sku. 12970222523	102 x 30 x 21 cm	3 338020 078400
Sku. 12970223030	127 x 26 x 26 cm	3 338020 081783



1-ENTRY COYPU CAGE TRAP

Category 1 coypu trap, size 82 x 31 x 31 cm. The unique bait rack ensures the bait is highly visible, so that the trap is even more effective. The epoxy-painted door is invisible to the animal when open. The Ø 2.6 mm wire mesh prevents the trap rusting whilst allowing it to blend in with its surroundings. Even if placed at the water's edge, it will keep its appearance and effectiveness for many years.

Sku. 1297021823030	82 x 31 x 31 cm	3 338020 081776
---------------------------	-----------------	-----------------



UKKAL

—
**MILK AND MEAT
PROCESSING**

- 154 Milk processing
- 157 Meat processing
- 163 Professional knives



NEW

ELECTRIC CREAM SEPARATOR 85 L



An easy-to-handle electric cream separator for skimming small quantities of milk, with a capacity of 85 litres of milk per hour. A simple, economical solution for those needing to separate cream from milk from time to time.

Ideal for small farmers with some dairy cows, goats or sheep or for hobby farmers. This separator is perfect for processing on the farm or for individuals wishing to make their own cream at home.

This model produces approximately 7% to 10% cream. This will vary according to the composition of the milk and the temperature.

The housing, milk and cream outlets and the bowl holder are made of plastic. The milk bowl is made of aluminium. The top bowl and the top bowl discs are also aluminium. Min. fill quantity: 2 L Max. fill quantity: 12 L. **2-year warranty.**

Sku. 150600010

- 40 x 24 x 42 cm
- 230 V
- Motor power: 55W
- Rotating speed: 10,500 rpm



CREAM SEPARATOR AR 140 ECO



The cream separator MILKY AR 140 ECO allows the separation of small and medium quantities of milk. It is very easy to handle. We recommend the use of this cream skimmer for semi-professionals, in particular for breeders wishing to start processing milk on the farms. The ideal solution for smallholders of dairy cows, goats or sheep, but also for hobbyfarming. Materials: The body is made of plastic. The milk and cream outlets, the container holder and the milk container are made of polished, food-grade aluminium. The upper bowl and the discs in the upper bowl are also food grade. **2-year warranty.**

Sku. 150600020

- Aluminium
- 40 x 24 x 42 cm
- 230 V
- Moteur power: 60 W - RPM : 8500
- Rotating speed



NEW

MANUAL CREAM SEPARATOR FJ85



Manual cream separator for separating cream from milk. 85 litres of milk per hour. Allows the separation of all types of cow, goat or sheep milk. This model of creamer allows to obtain about 6% to 8% of cream. This percentage varies according to the composition of the milk and the temperature. The bowl, discs and outlets are made of food-grade aluminium. The body is made of plastic for easy cleaning. Number of roller discs: 11: min./max. filling capacity: 2-12 L. Dimensions: 36.5 x 36.5 x 53.5 cm. Weight : 7,5 kg . **2 years warranty.**

Sku. 150600030

Productivity: 85 L/h





BUTTER CHURN

The manual 10 L, electric 10 L and electric 32 L MILKY butter churns are ideal for small productions. of homemade butters. These machines are intended for semi-professionals, professionals, as well as for farmers wishing to start milk processing on farms. They are the perfect solution for smallholders of dairy cows, goats or sheep, but also for hobbyfarming. They allow an optimal yield of between 32 % and 42% butter.

It consists of:

- a 10 litre or 32 litre cream container depending on the model.
- a removable stainless steel mixer
- a transparent plastic cover for permanent control
- a compartment for separating the buttermilk
- a multi-speed electric switch for individual control of butter production
- an automatic safety stop when the lid is removed during the process
- a powerful motor for speeding up or slowing down the butter production time.

Model 105L available on order.

ELECTRICAL 10L
Technical data:

- Tank volume: 10 L
- Working time per cycle: 20-35 min.
- Filling capacity from 1,5 to 3,8 L
- 4 speeds: 30 - 60 - 90 - 150 rpm
- Power: 550 W
- Dimensions: 39 x 33 x 31.5 cm
- Materials: plastic cover and stainless steel body

Sku. 150700010 

ELECTRICAL 32 L
Technical data:

- Tank volume: 32 L
- Working time per cycle: 20-35 min.
- Filling capacity from 6 to 13 L
- Power: 250/370 W
- Dimensions: 70 x 32 x 46 cm
- 2 speeds: 70 and 140 rpm
- Materials: plastic cover and stainless steel body

Sku. 150700030 



10 L



32 L





PASTEURIZER

The pasteurizers MILKY 15 L, 30 L, 50 L and 50 L with mixer allow the pasteurization of milk and juices, as well as the production of cheese, yoghurt and other dairy products. Can also be used for heating calf's milk (colostrum) for feeding, honey liquidation, honey wax production, etc. These machines are intended for semi-professionals as well as to farmers wishing to start milk processing on farms. They are the ideal solution for smallholders of dairy cows, goats or sheep, but also for hobbyfarming. The pasteurizer works on the model of a water bath. All pasteurizers consist of a removable filling tank, a double wall heated to the desired temperature, an inlet with a pipe for filling the double wall with cold water for cooling the milk, an outlet with a pipe for draining off the hot water, a thermometer on the lid, the lid lock for maintaining the heat and a control display (setting the water temperature + pasteurization heating time). The 50L pasteurizer with mixer also consists of:

- a mixer.
- a ctime setting.
- a stable mixer support for the table version (wheels for stable support).

Other models are available on request. Please see our website for more information on the products.

15 L



15 L

Technical data:

- Power: 230 W
- Tank volume: 15 L
- Filling capacity: 2 L-14 L
- Temperature setting: 4-100° C
- Time setting: 1 - 999 min
- Maximum temperature: 90°
- Dimensions: 32 x 32 x 52 cm
- Weight: 6 kg
- Stainless steel

Sku. 150800010



30 L



30 L

Technical data:

- Power: 230 W
- Tank volume: 30 L
- Min. filling capacity: 5 L-29 L
- Temperature setting: 4-100° C
- Time setting: 1 - 999 min
- Maximum temperature: 90°
- Dimensions: 48 x 48 x 55 cm
- Weight: 12 kg
- Stainless Steele

Sku. 150800020



MEAT MINCER



Semi-professional meat mincers REBER are intended for professionals who want robust and quality equipment for the processing of their minced meat and the production of homemade fillings. From farmers to meat professionals (butchers, charcutiers and caterers), we offer you a complete range of meat processing on the farm. The meat grinders have a hourly production from 30 to 160 kg and are guaranteed for 2 years. REBER brand of 100 % Italian manufacture. Guarantee of quality. All the meat mincers consist of an induction motor with continuous operation, an oil bath gearbox with a Long Life type oil suitable for contact with food, AISI 430 stainless steel fairing, body, propeller and a nut made of food certified tinned cast iron, a top plate made of stainless steel AISI 304, a steel plate, a knife made of C55 steel as standard and a pulse reversal switch.

Sku. 150100001	Meat mincer REBER N5 - 400 W • Dimensions: 35 x 17 cm • Height: 26,5 cm • Weight: 9 kg • Hourly production: 30/50 kg • Grid hole: 6 mm	
Sku. 150100002	Meat mincer REBER N12 - 500 W • Dimensions: 54 x 22 cm • Height: 32 cm • Weight: 16,3 kg • Hourly production: 50/90 kg • Grid hole: 6 mm • 2 funnels provided for gutting	
Sku. 150100003	Meat mincer REBER N22 Classic 600 W • Dimensions: 51 x 23 cm • Height: 33 cm • Weight: 31,3 kg • Hourly production: 70/120 kg • Grid hole: 8 mm	
Sku. 150100004	Meat mincer REBER N32 - 1200 W • Dimensions: 58 x 25,5 cm, • Height: 36 cm • Weight: 29,3 kg • Hourly production: 100-160 kg, • Grid hole: 10 mm	



TOMATO MILL MACHINE



Make delicious tomato sauces and purées, fruit juices and jams at home. Easily remove seeds from tomatoes and other fruit. Nylon body and worm screw. Treated with food grade resin. Supplied with hopper, splash guard, stainless steel strainer and filter and plastic pusher. Well made, durable item. Easy to clean. 2 years warranty. **Delivered without motor.**

Sku. 150150001	NO. 3 - Compatible with 400-W mincers (150100001). Weight: 1.2 kg		
Sku. 150150002	NO. 5 - Compatible with 500 W (150100002), 600 W (150100003) and 1200 W (150100004) mincers. Weight: 2.2 kg		





STAINLESS STEEL SAUSAGE FILLING MACHINES

The sausage filling machines have a stainless steel tube, a square bar steel rack to guarantee a major power take-off surface, a nylon 6,6 piston support, a cover, a piston and a plastic gasket for food use. We offer vertical or horizontal REBER plungers with capacities from 3 to 15 kg. All sausage filling machines have 2 speeds and are supplied with 4 funnels: 19, 25, 30 and 40.



Sku. 15020001	Sausage filling machines REBER 2 speeds 5 kg PRO	8 013152 895006
	<ul style="list-style-type: none"> • Capacity: 5 L • Dimensions: 57,5 x 33,5 cm • Height: 20,5 cm • Weight: 10,5 kg 	



Sku. 15020002	Sausage filling machines REBER 2 speeds 8 kg PRO	8 013152 895105
	<ul style="list-style-type: none"> • Capacity: 8 L • Dimensions: 67 x 33,5 cm • Height: 20,5 cm • Weight: 11,9 kg 	

Sku. 15020003	Sausage filling machines REBER 2 speeds 10 kg PRO	8 013152 895310
	<ul style="list-style-type: none"> • Capacity: 10 L • Dimensions: 74 x 41 cm • Height: 22 cm • Weight: 19,4 kg 	

Sku. 150201001	Stainless steel sausage filling machines REBER 2 speeds 5 kg PRO	8 013152 896065
	<ul style="list-style-type: none"> • Capacity: 5 L • Dimensions: 57,5 x 33,5 cm • Height: 20,5 cm • Weight: 10,4 kg 	

Sku. 150201002	Stainless steel sausage filling machines REBER 2 speeds 8 kg PRO	8 013152 896164
	<ul style="list-style-type: none"> • Capacity: 8 L • Dimensions: 67 x 33,5 cm • Height: 20,5 cm • Weight: 11,9 kg 	

Sku. 150201003	Stainless steel sausage filling machines REBER 2 speeds 10 kg PRO	8 013152 896317
	<ul style="list-style-type: none"> • Capacity: 10 L • Dimensions: 74 x 41 cm • Height: 22 cm • Weight: 19,4 kg 	

Sku. 150201004	Stainless steel sausage filling machines REBER 2 speeds 15 kg PRO	8 013152 896508
	<ul style="list-style-type: none"> • Capacity: 15 L • Dimensions: 86 x 26 cm • Height: 29 cm • Weight: 25 kg 	

Sku. 150202001	Stainless steel sausage filling machines REBER 2 speeds 3 kg PRO vertical	8 013152 896201
	<ul style="list-style-type: none"> • Capacity: 3 L • Dimensions: 28 x 24 cm • Height: 60 cm • Weight: 8,5 kg 	

Sku. 150202002	Stainless steel sausage filling machines REBER 2 speeds 5 kg PRO vertical	8 013152 897024
	<ul style="list-style-type: none"> • Capacity: 5 L • Dimensions: 40 x 31 cm • Height: 70 cm • Weight: 14 kg 	



FOOD SLICER



The ham slicers REBER, with 20 or 25 cm blades, are designed for professionals who want robust and quality equipment for cutting their meat, sausages and fish. From breeders to professionals in the meat industry (butchers, pork charcutiers and caterers), we offer you a complete range of meat processing. The ham slicers are guaranteed for 2 years. REBER brand of 100% Italian manufacture. Guarantee of quality. They have a die-cast aluminium base varnished with steel effect, a professional tempered and fitted 200 m steel blade with fixed protective ring, a movable partition made of molten aluminium with steel tips, a blade protector, a tray and a wall made of molten aluminium with a simple cleaning system, a blade shaft mounted on double ball bearing, a ventilated 140W professional motor, a safety button, a cutting thickness adjustment, a double ball bearing, a ventilated 140 W professional motor, a safety button, a cutting thickness adjustment. From 0 to 16 mm.



Sku. 150300001

REBER food slicer 20 cm blade

- Motor power: 140 W
- Dimensions: 46,5 x 34,5 cm
- Height: 29,5 cm
- Weight: 10 kg
- Cutting thickness adjustment from 0 to 16 mm
- Removable sharpener NOT INCLUDED available on request



Sku. 150300002

REBER food slicer 25 cm blade with sharpener

- Motor power: 140 W
- Dimensions: 53 x 48 cm
- Height: 37,5 cm
- Weight 13 kg
- Cutting thickness adjustment from 0 to 16 mm
- Fixed sharpener INCLUDED



AUTOMATIC VACCUM MACHINES



REBER automatic vacuum packing machines are ideal for automatically vacuum packing food. We recommend these machines for family, semi-professional or professional use. From farmers to meat professionals (butchers, charcutiers and caterers), we offer you a complete range of meat processing on the farm. The vacuum packing machines are easy to use, operate without stopping and waiting for cooling and are guaranteed for 2 years. All machines are supplied with 20 bags of 20 x 30 cm. They are equipped with an energy saving system. **For optimal vacuum packing, we strongly recommend the use of REBER bags. We do not guarantee the quality of the vacuum if bags of other brands are used.**



Sku. 150400001

Vacuum packing machine REBER automatic SALVASPESA PLUS

- Colour: white
- Dimensions: 37,5 x 17,5 x 11,5 cm.
- Weight: 3 kg
- Power: 180 W
- Empty: -830 mbar
- Suction: 18 lt/min
- Sealing bar: 32 cm



Sku. 150400002

Vacuum machine REBER automatic FAMILY DE LUXE

- Colour: silver
- Dimensions: 43,5 x 15,5 x 11 cm
- Weight: 3 kg
- Power: 190 W
- Empty: -830 mbar
- Suction: 18 lt/min
- Sealing bar: 32 cm. Supplied with suction hose for box



Sku. 150400003

Vacuum packing machine REBER stainless steel 30 cm (not illustrated)

- Colour: silver
- Dimensions: 37 x 27 x 11 cm
- Weight: 6,5 kg
- Power: 280 W.
- Empty: -900 mbar
- Suction: 40 lt/min
- Sealing bar: 32 cm. Supplied with a Hose connection for containers



Vacuum packing machine REBER stainless steel 40 cm

- Colour: silver
- Dimensions: 47 x 27 x 12 cm
- Power: 335 W
- Weight: 7,8 kg
- Empty: -900 mbar
- Suction: 40 lt/min. Supplied with a hose connection for containers.
- Sealing bar: 43 cm

Sku. 150400004



VACUUM BAGS AND ROLLS



Vacuum bags and rolls REBER are ideal for optimal vacuum packaging for the preservation of your food fresh. They are resistant and airtight. We recommend these bags and rolls for professionals. From breeders to meat professionals (butchers, pork charcutiers and caterers), we offer you a complete range of meat processing. The vacuum bags and rolls are easy to use. REBER brand of 100% Italian manufacture. **Guarantee of quality. REBER bags are tested for vacuum cooking up to a temperature of 100°C for a maximum of 4 hours. We recommend cooking at 60°C for 24 hours.** REBER triple-layer bags have all these qualities: 2 inner polyethylene layers suitable for contact with food, 1 outer layer of polyamide which guarantees airtightness against air penetration, 2 layers of polyethylene. These layers make the bag more resistant to punctures and tears and prevent the penetration of moisture, reduce the risk of leakage and the formation of frost and ice crystals in the freezer. Finally, the special indentations on the surface promote the exit and leakage of air and allow the creation of a true vacuum.



Sku. 150500015	100 embossed pockets 15 x 25 cm	8 013152 674205
Sku. 150500020	100 embossed pockets 20 x 30 cm	8 013152 672300
Sku. 150500025	100 embossed pockets 25 x 35 cm	8 013152 672416
Sku. 150500030	100 embossed pockets 30 x 40 cm	8 013152 673505
Sku. 150510020	2 rolls 20 x 600 cm	8 013152 672607
Sku. 150510030	2 rolls 30 x 600 cm	8 013152 672508
Sku. 150520005	50 pockets 40 x 50 cm 105 microns	8 013152 672591
Sku. 150520006	50 pockets 40 x 60 cm 105 microns	8 013152 672430

ELECTRONIC FOOD THERMOMETER



Electronic cooking thermometer for monitoring the temperature of meat, cheese etc. For hot or frozen food. Memory and digital temperature display. Also suitable for monitoring the temperature of air conditioning or soil. It can be boiled.

Technical data:

- Waterproof.
- Comes with battery.
- Scale range in Celsius: -50°C to +200°C.
- Scale range in Fahrenheit: -58°F to +392°F.
- With min. and max. action.
- Length: 20 cm.

Sku. 129027	20 cm	3 700393 922107
--------------------	-------	-----------------





GRIDS FOR MEAT MINCER REBER

You will find all our mincer grids: 4,5 mm, 6 mm, 8 mm, 10 mm, 12 mm. Depending on the desired result (minced meat, sausages, pâtés). These Grids are made of steel, which gives them a clean cut of the meat.



Sku. 9REB4007A/4	Grid 4,5 mm - Meat mincer N°5 REBER	8 013152 050405
Sku. 9REB4007A/8	Grid 8 mm - Meat mincer N°5 REBER	8 013152 050801
Sku. 9REB4007A/10	Grid 10 mm - Meat mincer N°5 REBER	8 013152 051006
Sku. 9REB4007A/12	Grid 12 mm - Meat mincer N°5 REBER	8 013152 051204
Sku. 9REB4312A/4	Grid 4,5 mm - Meat mincer N°12 REBER	8 013152 120412
Sku. 9REB4312A/8	Grid 8 mm - Meat mincer N°12 REBER	8 013152 120818
Sku. 9REB4312A/10	Grid 10 mm - Meat mincer N°12 REBER	8 013152 121013
Sku. 9REB4312A/12	Grid 12 mm - Meat mincer N°12 REBER	8 013152 121211
Sku. 9REB4312A/1	Diamond grid 3 holes - Meat mincer N°12 REBER	8 013152 431211
Sku. 9REB4714A/4	Grid 4,5 mm - Meat mincer N°22 REBER	8 013152 220419
Sku. 9REB4714A/6	Grid 6 mm - Meat mincer N°22 REBER	8 013152 220617
Sku. 9REB4714A/10	Grid 10 mm - Meat mincer N°22 REBER	8 013152 221010
Sku. 9REB4714A/12	Grid 12 mm - Meat mincer N°22 REBER	8 013152 221218
Sku. 9REB4714A/1	Diamond grid 3 holes - Meat mincer N°22 REBER	8 013152 471415
Sku. 9REB4750A/4	Grid 4,5 mm - Meat mincer N°32 REBER	8 013152 320409
Sku. 9REB4750A/6	Grid 6 mm - Meat mincer N°32 REBER	8 013152 320607
Sku. 9REB4750A/8	Grid 8 mm - Meat mincer N°32 REBER	8 013152 320805
Sku. 9REB4750A/12	Grid 12 mm - Meat mincer N°32 REBER	8 013152 321208



KNIVES FOR MEAT MINCER

Knives for meat mincer. Material: Steel type C55.

Sku. 9REB4006A	Knife TC 5	8 013152 400606
Sku. 9REB4311A	Knife TC 12	8 013152 120115
Sku. 9REB4712A	Knife TC 22	8 013152 220112
Sku. 9REB4752A	Knife TC 32	8 013152 475208



Based in the small Italian village of Premana, the MAGLIONERO brand has made a name for itself, over the last 50 years, in the craft manufacturing of professional knives. Its state-of-the-art factory works with chefs to design knives that cater as closely as possible to their needs. Its range now includes not only knives, but also complementary accessories such as sharpeners and products to care for your knives.



NEW

CLEAVER



This knife is specifically designed to work on large pieces of meat that are difficult to cut with a conventional knife. It is used for splitting or cutting bones. Made of AISI 420 stainless steel with a hardness of 52HRC. It has an ergonomic and sturdy handle to facilitate the cutting work. 1 year warranty.

Sk. 150310000



Blade: 22 cm
Length: 40 cm
Weight: 1,3 kg



Sk. 150310001



Blade: 26 cm
Length: 44 cm
Weight: 1,3 kg



NEW

CLEAVER "FRANCESE"



This knife is specifically designed for slicing, splitting or cutting up large carcasses (meat, poultry, etc.). Made of AISI 420 stainless steel with a hardness of 52HRC. It has an ergonomic and sturdy handle to facilitate cutting work. 1 year warranty.

Sk. 150310002



Blade: 24 cm
Length: 35 cm
Weight: 0,8 kg



NEW

BONE SAW WITH SCREW



This butcher's knife makes it easy to cut meat carcasses and bones. Its steel hoop will ensure better stability when cutting. It has a screw blade that can easily be changed. Made of AISI 420 stainless steel with a hardness of 52HRC. It has an ergonomic and sturdy handle for easy cutting. 1 year warranty.

Sk. 150310004



Blade: 50 cm
Length: 64 cm
Weight: 1 kg



Sk. 150310005



Blade: 50 cm
Weight: 40 g
Supplied alone



NEW

BUTCHER KNIFE "COLPO" ANATOMIC



This perfectly balanced chef's knife can be used for chopping and cutting meat, fish, fruit and vegetables - in short, the all-rounder. Made of AISI 420 stainless steel with a hardness of 52HRC. It has an ergonomic and sturdy handle for easy cutting. 1 year warranty.

Sk. 150310003



Blade: 28 cm
Length: 42 cm
Weight: 1 kg



NEW

BONING KNIFE LUX LINE



Frequently used in the butcher's shop, the boning knife allows, with its thin and curved blade, to bone, de-bone and degrease large pieces of butchery, game and poultry. Professional knives made from Bonpertuis X50CrMov15 stainless steel. Polished surface. Ergonomic, robust and refined handle for easy cutting. High grip and durability. Sterilisable material. 1 year warranty.

Sku. 150310006



Blade: 13 cm
Length: 26 cm
Weight: 90 g



NEW

BREAKING KNIFE LUX LINE



The breaking knife has a thin, curved blade for easy cutting and boning of meat pieces. Professional knives made from Bonpertuis X50CrMov15 stainless steel. Polished surface. It has an ergonomic, robust and refined handle for easy cutting. High grip and durability. Sterilisable material. 1 year warranty.

Sku. 150310007



Blade: 26 cm
Length: 38,5 cm
Weight: 150 g



NEW

STICKING KNIFE LUX LINE



This multi-purpose knife is ideal for everyday use for carving vegetables, making a garnish, chopping herbs...it can also be used for filleting small fish and cutting different pieces of meat. Professional knives made from Bonpertuis X50CrMov15 stainless steel. Polished surface. It has an ergonomic, robust and refined handle to facilitate cutting. High grip and durability. Sterilisable material. 1 year warranty.

Sku. 150310008



Blade: 14 cm
Length: 26 cm
Weight: 110 g



NEW

KITCHEN KNIFE FLUTED EDGE LUX LINE



This kitchen knife with fluted edge is versatile for your preparation tasks. The wide 21 cm blade makes it easy to slice through even the toughest foods without effort. The fluted edges help prevent food from sticking to the blade allowing you to complete preparation tasks quickly. Professional knives made from Bonpertuis X50CrMov15 stainless steel. Polished surface. Ergonomic, robust and refined handle for easy cutting. High grip and durability. Sterilisable material. 1 year warranty.

Sku. 150310009



Blade: 21 cm
Length: 33 cm
Weight: 160 g



NEW

BUTCHER KNIFE LUX LINE



The French kitchen knife is used for various cutting tasks: meat, fish, fruit and vegetables. Its very resistant blade is very popular with chefs. A precision tool that will serve you for years. Professional knives made from Bonpertuis X50CrMov15 stainless steel. Polished surface. Ergonomic, robust and refined handle for easy cutting. High grip and durability. Sterilisable material. 1 year warranty.

Sku. 150310010	Blade: 16 cm Length : 29 cm Weight: 130 g		
Sku. 150310011	Blade: 18 cm Length : 31 cm Weight: 140 g		
Sku. 150310012	Blade: 20 cm Length : 33 cm Weight: 160 g		
Sku. 150310013	Blade: 23 cm Length : 36 cm Weight: 180 g		
Sku. 150310014	Blade: 26 cm Length : 39 cm Weight: 200 g		





NEW

BREAD KNIFE LUX LINE



The bread knife has a large blade with sharp teeth for cutting all types of bread. It can also be used to cut fruits and vegetables with a hard skin. Professional knives made from Bonpertuis X50CrMov15 stainless steel. Polished surface. It has an ergonomic, robust and refined handle for easy cutting. High grip and durability. Sterilisable material. 1 year warranty.

Sku. 150310015		
Blade: 21 cm Length: 33,5 cm Weight: 100 g		





NEW

FISH KNIFE LUX LINE



The fish knife is recommended for quality cutting of fish. Its solid 18 cm blade will provide precision when cutting. Professional knives made from Bonpertuis X50CrMov15 stainless steel. Polished surface. It has an ergonomic, robust and refined handle to facilitate cutting. High grip and durability. Sterilisable material. 1 year warranty.

Sku. 150310016		
Blade: 18 cm Length: 31 cm Weight: 70 g		







NEW

CHROME PLATED CIRCULAR SHARPENING STEEL



The professional sharpening gun is the ideal tool for sharpening all your knives quickly and easily. It offers a very good resistance to wear. Its handle is comfortable and offers a good support during the sharpening operation. 1 year warranty.

Sku. 150310017	Round blade: 20 cm Length: 32,5 cm Weight: 170 g		
Sku. 150310018	Round blade: 30 cm Length: 44 cm Weight: 390 g		
Sku. 150310019	Oval blade: 30 cm Length: 44 cm Weight: 390 g		



NEW

FORGED COOKS FORK POMHANDLE



The meat fork has long prongs to hold the meat when cutting, it also allows you to turn and move your food when cooking. The length of the tines of 20 cm allows an optimal holding of the food. The handle is ergonomically designed, robust and refined for easy handling of food. High grip and durability. Sterilisable material. 1 year warranty.

Sku. 150310020



Teeth: 20 cm
Length: 32 cm
Weight: 170 g



NEW

POULTRY SHEARS



These stainless steel poultry scissors are designed for professionals who want to cut up poultry. With its high quality finish, it offers a clean and precise cut. It is robust and allows you to easily cut through the bones and gristle of poultry to prepare the meat. The ergonomic, robust and refined handle makes it easy to work with food. High grip and durability. Sterilisable material. 1 year warranty.

Sku. 150310021



Blade: 11 cm
Length: 25 cm
Weight: 380 g





UKAL

—
**HYGIENE AND
PROTECTION
OF THE BREEDER**

- 168 **Calving gloves**
- 169 **Disposable**
- 170 **Hygiene**
- 171 **Boots**
- 172 **Detergent**



POLYETHYLENE CALVING GLOVES

These gloves protect against micro-organisms in accordance with directive 89/686/ECC on personal protective equipment. Single use only. For search, calving and autopsy. 90 cm (35.5"). CE standard. Box of 100. The most resistant! 28 microns.

Sku. 101116



Box of 100



CALVING GLOVES

90 cm (35.5"). CE standard. 28 microns.

Sku. 101120



Bag of 50



SEPTICARE CALVING GLOVES



Septicare®

87 cm (34.3"). Thin but strong. These gloves provide protection against micro-organisms in accordance with directive 89/686/EEC on personal protective equipment. Box of 100. 20 microns. Best quality-price ratio.

Sku. 101121



Box of 100



5 FINGER ORANGE CALVING GLOVES

92 cm (35.5"). CE standards: EN 374-1 (1994) and EN 420 (1994). One size.

Sku. 101117100



Box of 100



EXAMINATION GLOVES WITH SHOULDER PROTECTION



Septicare®

Single-use examination glove. Covers the shoulder and armpit for a better fit. Does not slip down the arm. 100 % polyethylene, very resistant. Comes in a handy dispenser box. CE standard. 100 cm.

Sku. 101119001



Box of 50



BLUE HAIRNET

Blue mob cap in polypropylene. Latex free elastic. Diameter 48 cm. **For single use only.**

Sku. 101115800



By 100



NEW

VISITOR'S KIT

Practical, complete and compact.
The visitor kit includes:

- a gown,
- overboots,
- mask and a hairnet.

Ideal for all livestock farms visits.

For single use only.



Sku. 101115900	Sold singly		
		3 338020 054930	54
Sku. 101115910	Visitor kit without mask		
	NEW	3 700393 916830	20
Sku. 129117	Surgical masks by 50		
	NEW	3 701217 300118	40



DISPOSABLE OVERBOOTS

Polyethylene overboots with elastic for a better hold. Supplied in a bag of 25 pairs.



For single use only.

Sku. 1011140	
	5 703188 220103
By 25	



BLUE DISPOSABLE OVERALLS

Zip fastening. With hood but without overshoes. Blue. **For single use only.**

Sku. 101115915	
	3 700393 961960
XL	



DISPOSABLE OVERALLS

Zip fastening. With hood but without overshoes. **For single use only.**

Sku. 101115912V	L		
		5 703188 220103	50
Sku. 101115913V	XL		
		3 221170 003579	50
Sku. 101115914V	XXL		
		3 338020 077830	50



HYGIENE AND PROTECTION OF THE BREEDER | Hygiene



CALVING GOWN UKAL

Cotton coated with PU. Resistant to common cleaning agent. Available in navy blue. Used in the food processing industry. Back fixation with a stainless steel hook and elastic. Diameter: 13 mm. Thickness: 500 microns.

Sku. 101121010  3 494410 007532

M  

Sku. 101121011  3 494410 007556

L  



DAIRY APRON UKAL

Polyurethane. Adjustable neck strap. Back closing by stainless steel hook and elastic. Can be used with liquid up to 60°C. Thickness 500 microns. 380 gr/m². Dimensions: 90 x 115 cm.

Sku. 124080010  3 494410 007549

Blue  



DAIRY APRON UKAL

Very appreciated by the breeder! Resistant ! With neck strap, closing stainless steel hook in the back with elastic. Can be used with liquid up to 50°C. Thickness : 350 microns. 475 gr/m2. Dimensions 90 x 115 cm.

Sku. 124080001  3 494410 007792

White  



DAIRY SLEEVES

Blue polyurethane dairy sleeves with wrist and forearm tightening. Neoprene at the wrists and elastic at the biceps. Resistant to common cleaning products.

Sku. 124086002  3 494410 014233

By 2 / 40 cm  

Hygiene

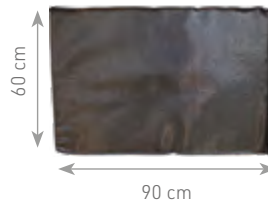

SEPTICARE HOOFMAT



Small and top class model. The whole hoof treated due to the thickness of the mat. Capacity: 21 liters.

Sku. 113100002  3 338020 063000

Dimensions : 90 x 60 x 4 cm



NEOPRENE PROTECTION SLEEVES



Waterproof protective dairy sleeves. They keep your forearms warm, dry and also protected. They are made from quality 3 mm neoprene. Simply pull them on over your wrist and take them off when you want! Can be used in farms, dairy farming and also gardening. In pairs.

Sku. 124087100  3 700393 914980

M  

Sku. 124087200  3 700393 914997

L  

Sku. 124087300  3 700393 915024

XL  

Sku. 124087400  3 700393 915017

XXL  



BOOT CLEANER KAMER

In order to ensure hygienic working conditions, you must start with caring for your boots. Cleans effortlessly. Stainless steel. Automatic. The brush is triggered as soon as the boot is put on. Delivered assembled.

Sku. 132910005  3 338020 064649

5 brushes  

04 LEISURE POLYURETHANE BOOTS



04

These polyurethane boots are twice as durable as rubber. They offer a high level of comfort thanks to their ergonomic sole and upper. A support provides ankle protection. Easy to clean and disinfect. A cutting line is drawn to allow them to be shortened cleanly.

Sku. 131610036 

Size: 36/37 

Sku. 131610038 

Size: 38/39 

Sku. 131610040 

Size: 40/41 

Sku. 131610042 

Size: 42 

Sku. 131610043 

Size: 43 

Sku. 131610044 

Size: 44 

Sku. 131610045 

Size: 45 

Sku. 131610046 

Size: 46 

Sku. 131610047 

Size: 47/48 

Sku. 131610049 

Size: 49/50 

S5 SAFETY POLYURETHANE BOOTS



S5

S5 safety boots equipped with a **steel toe cap** (high resistance 200 J) and an **antipenetration sole** (resistance to 1100 N). These polyurethane boots are twice as durable as rubber. They offer a high level of comfort thanks to their ergonomic sole and upper. A support provides ankle protection. Easy to clean and disinfect. A cutting line is drawn to allow them to be shortened cleanly. Recommended for agriculture, forestry, animal husbandry, mining, construction work.



DISCOVER OUR VIDEO

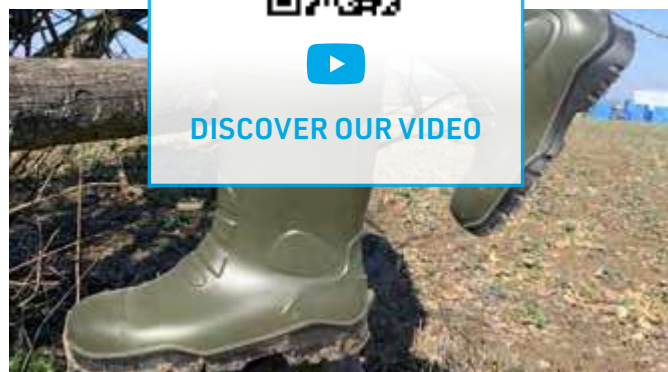

S4 SAFETY POLYURETHANE BOOTS



S4

S4 safety boots equipped with a **steel toe cap** (high resistance 200 J). These polyurethane boots are twice as durable as rubber. They offer a high level of comfort thanks to their ergonomic sole and upper. A support provides ankle protection. Easy to clean and disinfect. A cutting line is drawn to allow them to be shortened cleanly. Recommended for agriculture, forestry, animal husbandry, mining, construction work.

Sku. 131710036 

Size: 36/37 

Sku. 131710038 

Size: 38/39 

Sku. 131710040 

Size: 40/41 

Sku. 131710042 

Size: 42 

Sku. 131710043 

Size: 43 

Sku. 131710044 

Size: 44 

Sku. 131710045 

Size: 45 

Sku. 131710046 

Size: 46 

Sku. 131710047 

Size: 47/48 

Sku. 131710049 

Size: 49/50 

Sku. 131510037 

Size: 36/37 

Sku. 131510039 

Size: 38/39 

Sku. 131510041 

Size: 40/41 

Sku. 131510042 

Size: 42 

Sku. 131510043 

Size: 43 

Sku. 131510044 

Size: 44 

Sku. 131510045 

Size: 45 

Sku. 131510046 

Size: 46 

Sku. 131510048 

Size: 47/48 

Sku. 131510050 

Size: 49/50 

BOOTS REMOVER

Plastic boot remover with anti-slip ridge for extra grip. One size fits all.

Sku. 130E910698 

Black 





DISCOVER OUR VIDEO

Detergent

NEW

ECOLOGICAL PROFESSIONAL DETERGENT



99,5 % of natural ingredients. Detergent containing traditional Marseilles soap. Sulphatefree detergent made with Marseilles soap flakes and 100 % plant oils. Highly concentrated, it is suitable for all kinds of fabrics for machine and hand washing at 30°C. Hypoallergenic, formulated without fragrance to protect sensitive skin. For professional use. Organic product certified by ECOCERT.

Sku. 850005	5 L		
Sku. 850010	10 L		



EKO' PIN

CLEANING PRODUCTS THAT COMBINE *efficiency and ecology*



NEW



INDOOR AND
OUTDOOR RANGE



ECO-FRIENDLY
PACKAGING



French market only, ask us if you need information.



ukalel@ukal.com

UKALAGRI 173



UKAL

— BEAUMONT FENCING

- 179 **CLASSIC Range**
- 181 **PADDOCK Range**
- 183 **Permanent fencing**
- 184 **Connections**
- 184 **Strainers**
- 185 **Connections cables**
- 185 **Insulators**
- 188 **Handle**
- 189 **Fence posts**
- 190 **Accessories**
- 192 **Reels**
- 193 **Battery & testers**
- 194 **Nets**
- 198 **Practical guide**

CHOOSING THE RIGHT FENCING

Why use an electric fence?

- To keep your animals safe and protect them from intruders and threats from wild animals.
- To keep your animals in an enclosed space.
- To protect plots of land that you do not want your animals to stray onto.
- To set up mobile fencing to enable your animals to graze on fresh grass.

How does electric fencing for strip grazing work?

An ready-to-use electric fence for strip grazing is an open electrical circuit. The fence energizer generates a very shortlived electric pulse. This pulse lasts a matter of milliseconds. The electric fence for grazing is therefore not dangerous for humans in normal usage conditions. The fence wire and the earth are the electrical conductors.

During operation, no electric current passes through the electric fence.

The electric current only passes when the electrical circuit is closed.

This happens when an animal touches the fence wire. The electrical circuit is closed when the electric pulse passes through the animal and returns to the energizer via the earth. This generates a shock, which guarantees that the fence acts as a deterrent.

When is the electrical circuit not closed?

- When the wire is broken.
- When the electrical conductivity of the fence materials is poor and the current cannot pass.
- When the animal's fur is too thick.
- When the fence is covered with too much vegetation. The current flows into the earth.
- Due to incorrect and insufficient earthing of the fence energizer.
- Due to excessively dry conditions, or when the soil is covered by ice which acts as an insulator.

The importance of earthing

This is the most important aspect, and yet it is the one that is most often neglected when setting up an electric fence. Do not forget that an electric fence will not function if it is not properly earthed. It is important to make sure the earth rod is properly buried in the soil in a place with plenty of moisture. The earth rod cable must be correctly screwed into the energizer terminal.

NOTE: You must not use the earth of the building's mains power supply.

The earth of the mains power supply and the earth of the fence must be at least 10 m apart.

For difficult installations (long fences, very dry soil), maximise efficiency by having multiple earths. If the voltage measured is greater than 300 V (0.3 kV), then the earthing is insufficient and must be improved using additional earth rods.

FENCE HEIGHT

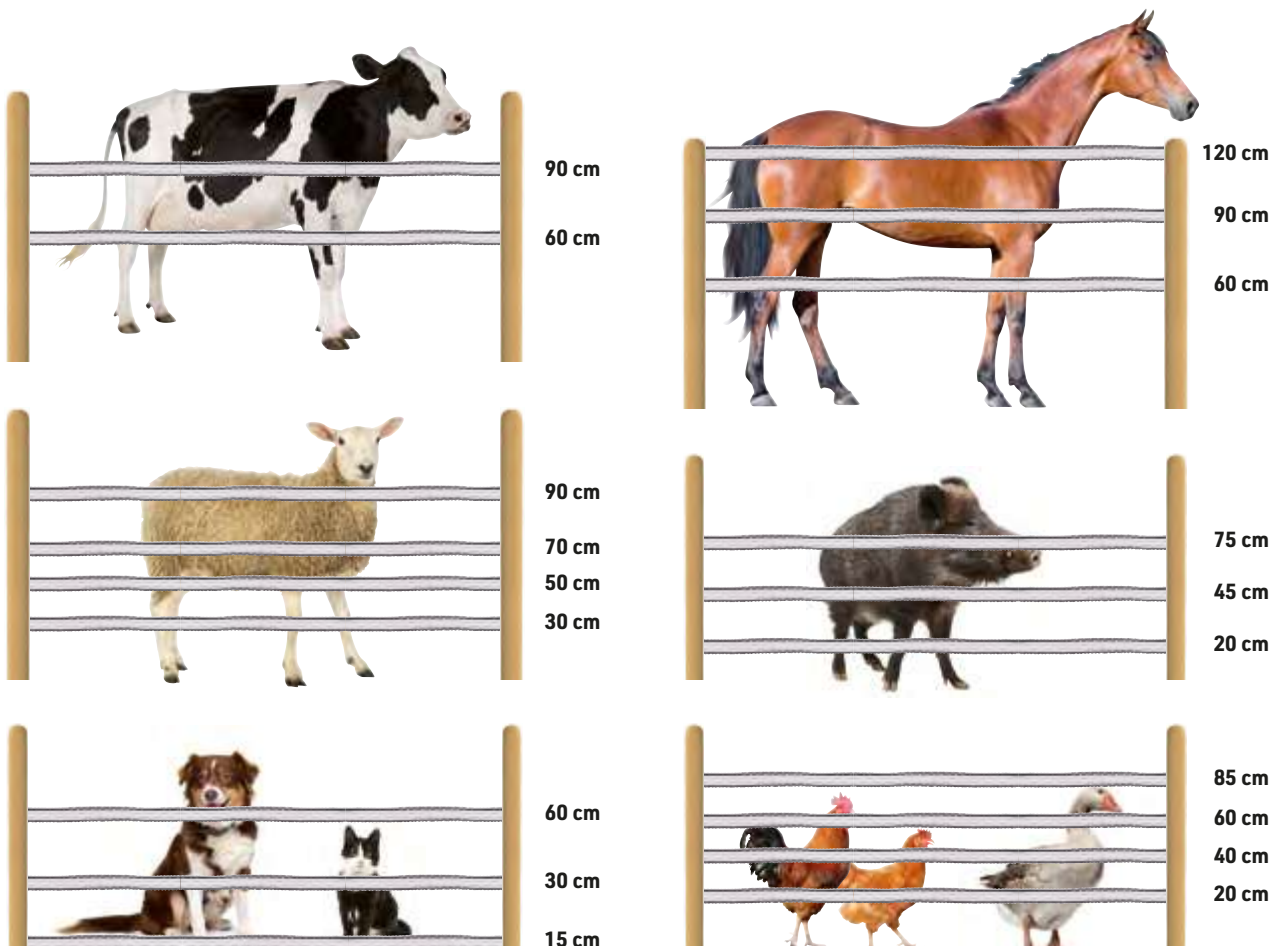









ENERGIZER COMPARISON

Product reference	Product name	Power supply	Stored energy	Output energy	Distance in the laboratory CEE	Number of nets							
-------------------	--------------	--------------	---------------	---------------	--------------------------------	----------------	------------------------------------------------------------------------------------	-------------------------------------------------------------------------------------	-------------------------------------------------------------------------------------	-------------------------------------------------------------------------------------	-------------------------------------------------------------------------------------	-------------------------------------------------------------------------------------	-------------------------------------------------------------------------------------

CLASSIC

125920050	P180		0,18 J	0,12 J	4 km	NA							
125921020 125921020SP	RB880		1,25 J / 12 V 0,7 J / 9 V	0,98 J / 12 V 0,5 J / 9 V	20 km	5 x 50 m							
125923005	RB85		0,85 J	0,45 J	8 km	2 x 50 m							
125923023	S170		1,7 J	1,4 J	55 km	8 x 50 m							
125923024	S440		4,4 J	3,0 J	115 km	10 x 50 m							
125923025	S510		5,1 J	3,8 J	130 km	12 x 50 m							

PADDOCK

125940050	P180		0,18 J	0,12 J	4 km	NA							
125943980	RB880	 	1,25 J / 12 V 0,7 J / 9 V	0,98 J / 12 V 0,5 J / 9 V	20 km	5 x 50 m							
125943045	S510		5,1 J	3,8 J	130 km	12 x 50 m							
125943005	RB85		0,85 J	0,45 J	8 km	2 x 50 m							

BEAUMONT QUALITY

Beaumont is a brand with expertise built through years of hands-on experience.

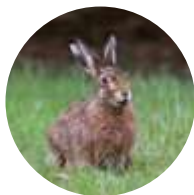

NON-DEFORMABLE



SOLID



WELDED MESH

**The quality of Beaumont nets is tried and tested.
The performance of the products in the field speaks for itself.**





























Contact us for further information on +33 (0)3 88 07 40 15



CONDUCTOR COMPARISON

Product reference	Tape/Wire/Rope	Length	Diameter or width	Number of conductors	Conductor type	Resistance	Breaking load							
-------------------	----------------	--------	-------------------	----------------------	----------------	------------	---------------	-------------------------------------------------------------------------------------	-------------------------------------------------------------------------------------	-------------------------------------------------------------------------------------	-------------------------------------------------------------------------------------	-------------------------------------------------------------------------------------	-------------------------------------------------------------------------------------	-------------------------------------------------------------------------------------

CLASSIC

125165312	Tape	200 m	12 mm	4 x 0,20 mm / 1 x 0,15 mm	-	5,8 ohms/m	115 kg							
125165320	Tape	200 m	20 mm	6 x 0,20 mm / 1 x 0,15 mm	-	3,9 ohms/m	90 kg							
125165340	Tape	200 m	40 mm	8 x 0,20 mm / 1 x 0,15 mm	-	2,90 ohms/m	280 kg							
125165112	Wire	200 m	-	6 x 0,15 mm	Stainless steel	7,20 ohms/m	45 kg							
125165114	Wire	400 m	-	6 x 0,15 mm	Stainless steel	7,20 ohms/m	45 kg							
125165216	Rope	200 m	Ø 6 mm	8 x 0,20 mm	Stainless steel	2,9 ohms/m	450 kg							
125165186	Wire	200 m	-	Conductor stainless steel 3 x 0,15 mm + 1 x 0,20 mm	-	0,53 ohms/m	48 kg							
125165188	Wire	400 m	-	cuiivre 1 x 0,20 mm	-	0,53 ohms/m	48 kg							
125176215	Braided rope	200 m	Ø 5 mm	Conductor stainless steel 4 x 0,15 mm + 1 x 0,20 mm copper	-	0,18 ohms/m	400 kg							

The energizers and conductors for different animal species are given as a guide only.

Paddock

125167120	Tape	200 m	20 mm	6 x 0,15 mm	Stainless steel	7,2 ohms/m	90 kg							
125167140	Tape	200 m	40 mm	10 x 0,15 mm	Stainless steel	4,32 ohms/m	180 kg							
125167005	Rope	200 m	Ø 5 mm	6 x 0,15 mm	Stainless steel	7,20 ohms/m	120 kg							
125167312	Tape	200 m	12 mm	4 x 0,20 mm + 1 x 0,15 mm	Stainless steel	5,8 ohms/m	115 kg							
125167320	Tape	200 m	20 mm	6 x 0,20 mm + 1 x 0,15 mm	Stainless steel	3,9 ohms/m	140 kg							
125167340	Tape	200 m	40 mm	8 x 0,20 mm + 1 x 0,15 mm	Stainless steel	2,9 ohms/m	280 kg							
125167216	Tape	200 m	Ø 6 mm	8 x 0,20 mm	Stainless steel	2,9 ohms/m	140 kg							



CLASSIC P180
BATTERY-POWERED ENERGIZER



Practical, easy-to-use battery-powered energizer. Easily transportable, with a long battery life due to its low energy consumption. For fences up to 4 km long without vegetation. Indicator light. 2.5 W solar charger included to increase running time.

Sku. 125920050 

9V - 12V - Solar panel 2,5 W 



CLASSIC RB880
3-IN-1 ENERGIZER



Ideal for long fences. Multifunction energizer. Works on a battery, 9 V batteries, or the mains power supply. 10 W solar panel included. To plug the energizer into the mains, you will need to add a transformer (not included). Handle for easy transport. Battery level indicator. 3 display levels. Multi-purpose, convenient and easy to use. Our recommendation if you are looking for an energizer suitable for all terrains!

Sku. 125921020 

9V - 12V - 230 V - Solar panel 10 W 

Sku. 125921020SP 

9V - 12V - 230 V - Energizer only 



CLASSIC RB85
MAINS ENERGIZER



This compact, modern energizer is ideal for pet owners. Suitable for medium-length fences: permanent fencing for cattle/sheep/ goats / dog fencing / protective fencing for crops, ponds and gardens.

Sku. 125923005 

230 V 



CLASSIC S170
MAINS ENERGIZER



Shock-resistant ABS housing. Indicator lights. Designed for medium-sized fences. Ideal for medium-sized fences for sensitive species (dogs, horses, etc.).

Sku. 125923023 

230 V 



CLASSIC S440
MAINS ENERGIZER



Shock-resistant ABS housing. Energizer equipped with an operation indicator light and 2 power outputs. Suitable for all animal species. For large and mid-sized fences.

Sku. 125923024 

230 V 



CLASSIC S510
MAINS ENERGIZER



2 power outputs (one high and one low) to adapt the power level to your needs or electrify two separate fences. Powerful energizer for fences up to 35 km long without vegetation and 6 km with very dense vegetation. 6-step LED voltage indicator. 2 power outputs (one high and one low). Can be used to electrify up to 12 nets. Easy to use. Energizer recommended for long and very long fences in difficult conditions (dense vegetation, animals that are difficult to contain).

Sku. 125923025 

230 V 



FENCING BEAUMONT | CLASSIC Range

All our engiergers come with a 2-year warranty and a warning sign.

Technical characteristics	Sku. 125920050	Sku. 125921020	Sku. 125923005	Sku. 125923023	Sku. 125923024	Sku. 125923025
Power supply	9 V / 12 V	9 V / 12 V / 230 V	230 V	230 V	230 V	230 V
Stored energy	0,18 J	1,25 J / 12 V - 0,7 J / 9 V	0,85 J	1,7 J	4,4 J	5,1 J
Output energy	0,12 J	0,98 J / 12 V - 0,5 J / 9 V	0,45 J	1,4 J	3,0 J	3,8 J
Voltage	8 500 V	10 800 V / 12 V - 7 000 V / 9 V	7 800 V	9 500 V	10 500 V	10 000 V
Voltage at 500 Ohms	1 500 V	3 800 V	3 800 V	5 000 V	5 700 V	5 600 V
Power consumption	2,5 W	10 W	1 W	3 W	5 W	8 W
Indicator light	Yes	3- steps	No	Yes	2 power outputs	6-step LED voltage indicator, 2 power outputs (one high and one low)
Distance in the laboratory CEE	4 km	20 km	8 km	55 km	115 km	130 km
Distance with little or no vegetation	0,9 km	1,1 km	3,5 km	15 km	20 km	35 km
Distance with moderate vegetation	2 km	2 km	2 km	4,5 km	7 km	13 km
Distance with dense vegetation	0,8 km	1,7 km	0,8 km	1,7 km	2 km	6 km
Number of nets	2 x 50 m	8 x 50 m	2 x 50 m	8 x 50 m	10 x 50 m	12 x 50 m



GREEN AND WHITE TAPES

Sku. 125165312	
12 mm / 200 m	
Sku. 125165320	
20 mm / 200 m	
Sku. 125165340	
40 mm / 200 m	



GREEN AND WHITE ROPE

Sku. 125165216	
Ø 6 mm / 200 m	



TWISTED GREEN AND WHITE WIRES

Sku. 125165112	
200 m	
Sku. 125165114	
400 m	



BRAIDED WIRES AND ROPES

The monofilaments that make up the wire and the rope are braided in a 3 mm sheath. The monofilaments have more elasticity than ordinary materials. A copper conductor provides the best resistance for fence longer than 1 000 m.

Sku. 125165186	
Braided wires 200 m	
Limited stock	
Sku. 125165188	
Braided wires 400 m	
Limited stock	
Sku. 125176215	
Braided ropes 5 mm / 200 m	
Limited stock	

Technical characteristics	Sku. 125165312	Sku. 125165320	Sku. 125165340	Sku. 125165216	Sku. 125165112	Sku. 125165114	Sku. 125165186	Sku. 125165188	Sku. 125176215
Width x length	12 mm x 200 m	20 mm x 200 m	40 mm x 200 m	Ø 6 mm x 200 m	200 m	400 m	200 m	400 m	200 m
Number	4 x 0.20 mm / 1 x 0.15 mm	6 x 0.20 mm / 1 x 0.15 mm	8 x 0.20 mm / 1 x 0.15 mm	Stainless steel conductor 8 x 0.20 mm	Stainless steel conductor 6 x 0.15 mm	Stainless steel conductor 6 x 0.15 mm	Stainless steel conductor 3 x 0.15 mm / 0.20 mm copper	Stainless steel conductor 3 x 0.15 mm / 0.20 mm copper	Stainless steel conductor 4 x 0.15 mm / 0.20 mm copper
Resistance	5.8 ohms/m	3.9 ohms/m	2.9 ohms/m	2.9 ohms/m	7.20 ohms/m	7.20 ohms/m	0.53 ohms/m	0.53 ohms/m	0.18 ohms/m
Breaking load	115 kg	90 kg	280 kg	450 kg	45 kg	45 kg	48 kg	48 kg	400 kg

PADDOCK P180 BATTERY-POWERED ENERGIZER



Practical, easy-to-use battery-powered energizer. For fences up to 4 km long without vegetation. Indicator light. 2.5 W solar charger included to increase running time. 2 years warranty.

Sku. 125940050



9V - 12V - Solar panel 2,5 W



PADDOCK RB880 3-IN-1 ENERGIZER



Ideal for long fences. Multifunction energizer. Works on a battery, batteries, or the mains power supply. 10 W solar panel included. To plug the energizer into the mains, you will need to add a transformer (not included). Handle for easy transport. Battery level indicator. 3 display levels. Multi-purpose, convenient and easy to use. 2 years warranty.

Sku. 125943980



9V - 12V - 230 V - Solar panel 10 W



PADDOCK S510 MAINS ENERGIZER



Energizer equipped with 2 outputs (maximum and reduced) to adapt the power level to your needs or to electrify two independent fences. Powerful energizer for fences up to 30 km long without vegetation and 6 km with very dense vegetation. 6-step LED voltage indicator. 2 power outputs (one high and one low). Easy to use. Energizer recommended for long and very long fences in difficult conditions (dense vegetation, animals that are difficult to contain). 2 years warranty.

Sku. 125943045



230 V



PADDOCK RB85 MAINS ENERGIZER



This compact, modern energizer is ideal for horse owners. Suitable for medium-length fences. 2 years warranty.

Sku. 125943005



230 V



Technical characteristics	Sku. 125940050	Sku. 125943980	Sku. 125943045	Sku. 125943005
Power supply	9 V / 12 V	9 V / 12 V / 230 V	230 V	230 V
Stored energy	0.18 J	1,25 J / 12 V - 0,7 J / 9 V	5.1 J	0,85 J
Stored energy	0.12 J	0,98 J / 12 V - 0,5 J / 9 V	3.8 J	0,45 J
Voltage	8 500 V	10 800 V / 12 V - 7 000 V / 9 V	10 000 V	7 800 V
Voltage at 500 Ohms	1 500 V	4 500 V / 12 V - 3 000 V / 9 V	5 600 V	3 800 V
Power consumption	15 mA / 12 V - 22 mA / 9 V	90 mA / 12 V - 70 mA / 9 V	8 W	1 W
Indicator light	Yes	3 display levels	6-step LED voltage indicator. 2 power outputs (one high and one low)	No
Distance in the laboratory CEE	4 km	20 km	130 km	8 km
Distance with little or no vegetation	2.8 km	9.5 km	35 km	3,5 km
Distance with moderate vegetation	0.9 km	3.3 km	13 km	2 km
Distance with dense vegetation	0.2 km	1.1 km	6 km	0,8 km
Number of nets	NA	5 x 50 m	12 x 50 m	2 x 50 m

All our energizers come with a 2-year warranty and a warning sign.

FENCING BEAUMONT | Paddock Range

BROWN TAPES  Closure électrique - Elektrozaun - Electric fencing

These tapes have an anti-UV treatment.

Sku. 125167120  3 700393 941405

20 mm / 200 m 

Sku. 125167140  3 700393 913259

40 mm / 200 m 



GREEN AND WHITE TAPES  Closure électrique - Elektrozaun - Electric fencing

These tapes have an anti-UV treatment.

Sku. 125167312  3 700393 911804

12 mm / 200 m 

Sku. 125167320  3 700393 911781

20 mm / 200 m 

Sku. 125167340  3 700393 911798

40 mm / 200 m 



BROWN ROPE  Closure électrique - Elektrozaun - Electric fencing

These rope have an anti-UV treatment.

Sku. 125167005  3 700393 941429

Ø 5 mm / 200 m 



GREEN AND WHITE ROPE  Closure électrique - Elektrozaun - Electric fencing

These rope have an anti-UV treatment.

Sku. 125167216  3 700393 911811

Ø 6 mm / 200 m 





Technical characteristics	Sku. 125167120	Sku. 125167140	Sku. 125167005	Sku. 125167312	Sku. 125167320	Sku. 125167340	Sku. 125167216
Length	20 mm x 200 m	40 mm x 200 m	Ø 5 mm x 200 m	12 mm x 200 m	20 mm x 200 m	40 mm x 200 m	Ø 6 mm x 200 m
Number of stainless steel conductors	6 x 0.15 mm	10 x 0.15 mm	6 x 0.15 mm	4 x 0.20 mm + 1 x 0.15 mm	6 x 0.20 mm + 1 x 0.15 mm	8 x 0.20 mm + 1 x 0.15 mm	8 x 0.20 mm
Resistance	7.2 ohms/m	4.32 ohms/m	7.20 ohms/m	5.8 ohms/m	3.9 ohms/m	2.9 ohms/m	2.9 ohms/m
Breaking load	90 kg	180 kg	120 kg	115 kg	140 kg	280 kg	140 kg

NEED TO CLOSE A POULTRY HOUSE?
 Discover the HOBBY range from Beaumont, ideal for guarding and securing your backyard.

 Closure électrique - Elektrozaun - Electric fencing

→ Discover HOBBY range in our UKAL GREEN catalog page 15

GALVANISED STEEL CABLE



Breaking load 200 kg. Good conductivity.

Sku. 125140001 

250 m 

Sku. 125140002 

500 m 



ZINC-COATED STEEL CABLE



Zinc-coated steel cable with aluminium powder. Excellent conductor. Breaking load 200 kg. Resistance: 0.12 ohms/m.

Sku. 125141 

500 m 



ALUMINIUM CABLE



Breaking load 200 kg. Good conductivity.

Sku. 125145020 

Ø 2 mm / 400 m 



Lead-out cable

SOFT LEAD-OUT CABLE



Soft lead-out cable.

Sku. 125450030 

30 m 

Sku. 125450 

50 m 



PERMANENT FENCING
Choose the best solution
for your pasture fence!

→ Discover our range
in the dedicated
brochure



FENCING BEAUMONT | Connections and strainers

Connections



CONNECTION FOR ROPES



Connection for wire and rope. Guarantees high-quality connections.

Sku. 125139015 3 338020 042999

Stainless steel - By 5 128

Sku. 125139016 3 338020 085651

Aluminium - By 5 54



WIRE CONNECTOR SCREWS



Screw for connecting several cables.

Sku. 125139014 3 700393 941719

By 10 **Limited stock** 10

CONNECTION FOR TAPE



Sku. 125139006 3 388770 020051

20 mm - Aluminium - By 5 80

Sku. 125139046 3 388770 040059

40 mm - Aluminium - By 5 80

Sku. 125139120 3 338020 077083

20 mm - Steel - By 5 178

Sku. 125139140 3 338020 077090

40 mm - Steel - By 5 178



CONNECTION FOR TAPE



Easy to use. Suitable for all standard electric fence tapes. Galvanised metal support. Robust tape connector through the metal support of a part, supported by unbreakable plastic.

Sku. 125139220 3 700393 916458

20 mm - By 10 **Limited stock** 36

Sku. 125139240 3 700393 916465

40 mm - By 5 **Limited stock** 64

Strainers



WIRE STRAINER WITH SPRING



Made of stainless steel.

Sku. 125139020 3 338020 061976

By unit 28



STRAINER FOR WIRE AND ROPE



For straining wire and rope. Includes locking system.

Sku. 125139013 3 700393 941726

By 2 **Limited stock** 80



TAPE STRAINER



Made of aluminium.

Sku. 125139010 3 338020 037995

By unit 74

Connections cables

TAPE/WIRE CONNECTION CABLE

Sku. 125191



By 2



84



TAPE-ROPE CONNECTION CABLE

Sku. 125192002



By unit
Limited stock



80



Professional cable for connecting a tape (40 mm max.) and a rope (6 mm max).
Stainless steel contact plate. Cable length: 60 cm.



CONNECTION CABLE FOR ROPES UP TO 6 MM

Professional connection cable for ropes up to 6 mm max. Cable length: 60 cm.

Sku. 125192003



By unit
Limited stock



100



Insulators

RING INSULATOR

Duplicate-moulded. Designed for wire, cable and tape conductors, up to 12 mm. Robust body with screw, perfect for screwing into wooden posts.

Sku. 125201



Black - By 25



22

Sku. 125201090



Black - By 90

Sku. 125201250



Black - By 250



PREMIUM 3-IN-1 INSULATOR

These uniquely shaped insulators are easy to hold in your hand and to screw in even without a tool. The special feature is the construction of the insulator head. The fence material is inserted easily from above, so the fence material will not fall out at a later date. Special insulator for ropes. Recommended for long fences. Short support. Anti-water-droplet system. Self-tapping screw.

Sku. 125226



Black - By 20
Limited stock



15



COMBINED WOOD AND STEEL RB INSULATOR

Universal, with captive pin. Fastens to a diameter 10-12mm steel post at the required height, to a round or flat wooden post with wire, two screws or two nails.

Sku. 125200050



Black - By 50



18



RBL CAPTIVE-PIN INSULATOR

Fastens to a post with only one wire. For wires or cable conductors. Withstands 15 000 V.

Sku. 125266



Red - by 50



40

Sku. 125266100



Red - by 100



20





FENCING BEAUMONT | Insulators



RBCH INSULATOR

Large model for tapes up to 40 mm, cables and ropes. The screws make it possible to strain the tape properly and install it easily.

Sku. 125223  3 388770 080253



Black - By 25  



INSULATOR FOR WIRE & TAPE, 40 MM

Screw-in insulator for wooden posts. Short support. Self-tapping screw. For tapes up to 40 mm wide. For wires and ropes up to 8 mm in diameter. Extremely long, distinct and tapered screw thread. Self-tapping screw for easy tightening. No need for prior drilling or countersinking in the wood. The insulator screw is made of tempered steel.

Sku. 125225  3 700393 918902



Black - By 30  



INSULATOR FOR TAPE 12 TO 40 MM AND ROPE

12 to 40 mm tape insulator and for rope up to 8 mm.

Sku. 125207  3 700393 913853

Black - By 25  

Sku. 125207090  3 700393 913860



Black - By 90



INSULATOR FOR TAPE (20 MM MAX.) AND ROPE (8 MM MAX.)

Insulator for tape up to 20mm and rope up to 8mm. With a snap fastener.

Sku. 125209  3 700393 942037

Black - By 25  



DELUXE RING INSULATOR, LARGE MODEL

This insulator has a UV treatment.

Sku. 125230101  3 338020 061891



Black - By 25 **Limited stock** 



BLACK UNIVERSAL INSULATOR

Nail-on insulator for wire and tape, for round posts diameter 10/12 mm.

Sku. 125200  3 338020 034222

Black - By 25 **Limited stock**  



NAIL-ON INSULATOR FOR TAPE AND ROPE

Nail-on insulator for tape : 40mm max. and rope: 6mm max.

Sku. 125220001  3 700393 942020



Black - By 25  



IGPB KIT WITH 2 FASTENING PLATES AND 2 RBCH INSULATORS

Kit includes: 2 RBCH insulators, 2 aluminium fastening plates for 40 mm tape.

Sku. 125408003  3 388779 760026

Black - By unit  



DOUBLE ANCHORING INSULATOR



Essential for installing gates.

Sku. 125281



Black - By 2



64



CORNER INSULATOR PULLEY-TYPE



Very good resistance.

Sku. 125211



Black - By 2



60



BLACK PLASTIC ROLLER INSULATOR



For screwing on wooden posts.

Sku. 125210



Black - By 25



22



EGG INSULATOR



Standard quality. Ideal for corners. To be used with wire.

Sku. 125231



Black - By 4



65



STANDOFF RING INSULATOR



Black plastic. Allows to create a distance between the animal and the fence.

Sku. 125230



Black - By 10



16

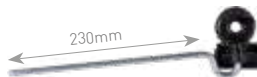

STANDOFF INSULATOR



Duplicate-moulded over 6mm diameter.

Sku. 125230001



Black - By 10



16



STRAIGHT STANDOFF RING INSULATOR



Black plastic straight insulator. Allows to create a distance between the animal and the fence.

Sku. 125230002



Black - By 10



24



PIGTAIL INSULATORS



Insulator for metal or fibreglass fence posts.

Sku. 125250



White - Ø 10 mm - By 50



20

Sku. 125251



White - Ø 12 mm - By 50



20

Sku. 125253



White - Ø 50 mm - By 25



30



METAL CORKSCREW INSULATOR



For oval posts.

Sku. 125276



Yellow - Par 25



18



FENCING BEAUMONT | Insulators and handles



ANTENNA INSULATOR



For top of steel post Ø 12 mm. For wires or cable conductors. Withstands 20 000 V.

Sku. 125280



Black - By 10



ISOLATEUR RB



Universal insulator for wires and tape. Fastens to diameter 6 - 13 mm posts via a nut system.

Sku. 125200400



Black - Par 25



Handles



SPRING TYPE INSULATING GATE HANDLE



Gate handle with extension internal spring.

Sku. 125405010



Black - By 10



LARGE BLACK SPRING-TYPE, INSULATING HANDLE



With spring.

Sku. 125404002/2



Black - By 2



EXTRA-LARGE BLACK GATE HANDLE WITH HOOK



Can also be used as a spool for spooling wire and tape up to 20 mm max.

Sku. 125404004



Black - By unit
Limited stock



SPRING-TYPE INSULATING GATE HANDLE



With internal extension spring.

Sku. 125401



Yellow - By 2



Sku. 125403



Red - By 2



Sku. 125405



Black - By 2



INSULATING GATE HANDLE WITH EXTENSIBLE ELECTRIFIED CORD



Elastic kit with insulating gate handle, recommended for horse enclosures. Can be used to create gateways for farm equipment (opening of up to 8 m).



Sku. 125407



Black - By unit



GATE HANDLE KIT WITH 5 M SPRING



Gate handle : 26cm. 5 m of spring.



Sku. 125406



Handle + spring kit
Black - By unit



Sku. 125406001



Spring only - Black
By unit



INSULATING HANDLE KIT WITH TAPE FASTENING PLATE



Gate handle with plate by piece. Gate handle: 26cm. Plate: 15cm.



Sku. 125408002



Black - By unit



GATE HANDLE WITH 5 M SPRING



Insulating handle with integrated 5 m spring. Easy to set up for temporary fences. Diameter: 2 cm.



Sku. 125406002



Black - By unit



INSULATING SPRING-TYPE HANDLE WITH INSULATOR



Double anchoring insulator Sku. 125281.



Sku. 125402



Black - By unit
Limited stock



FENCING BEAUMONT | Fence posts

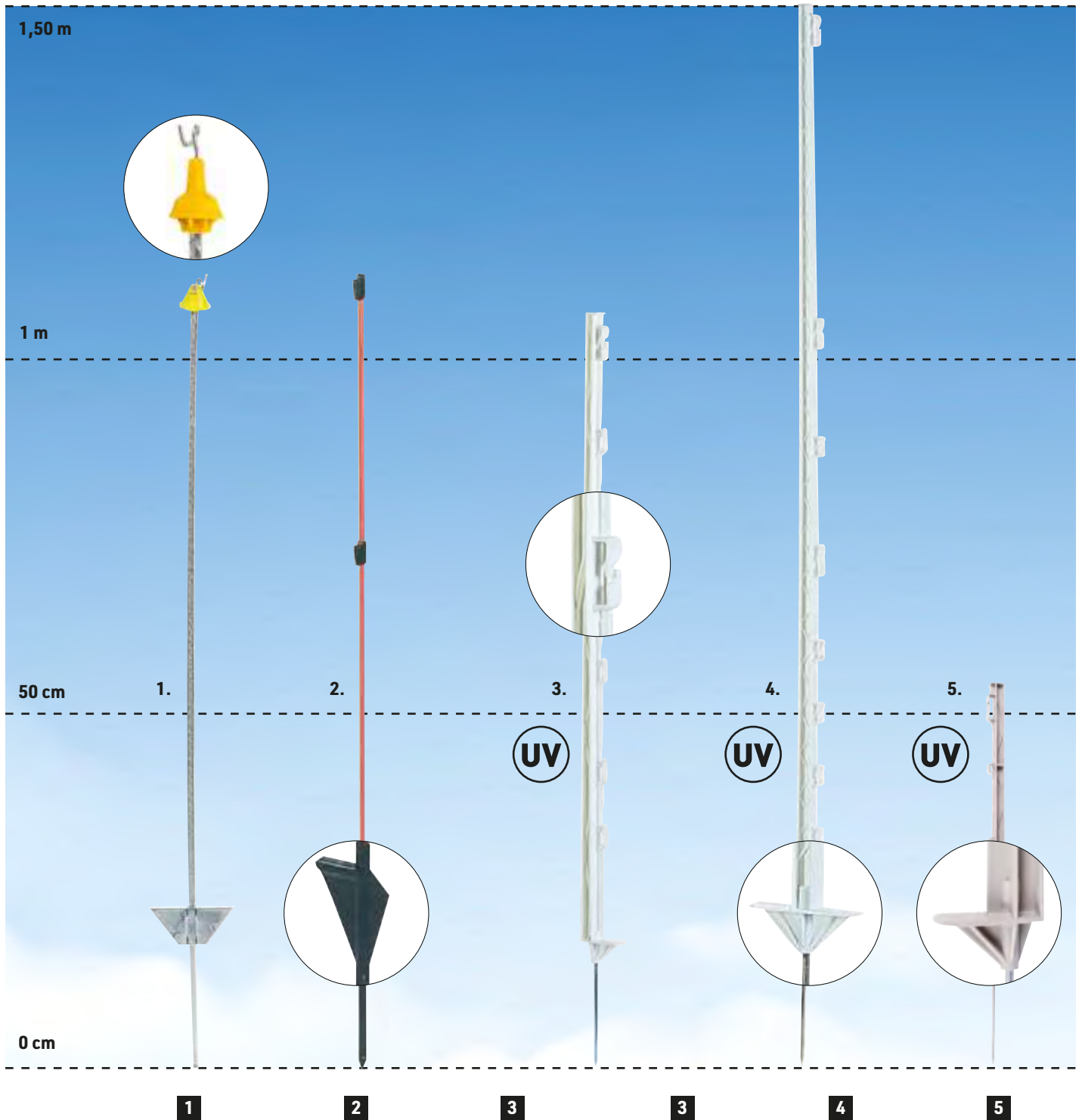

SKU.	125305025	125312050	125331030	125331600	125335020	125340107010
Material	Metal	Fiberglass	Plastic	Plastic <i>Limited stock</i>	Plastic	Plastic
Height*	1,10 m	1,10 m	1,05 m	1,05 m	1,50 m	1,05 m
Number of insulators	1	0	7	7	8	7
Sold in multiples of	25	50	30	600	20	10
Pallet	1 250	1 000	700	600	700	600
Animals						
Gencode						

*Measurement includes full shaft.

UNIVERSAL FENCE PLIERS



Multipurpose tool. Insulated handle.

Sku. 125296



By unit



32

WARNING SIGNS FOR ELECTRIC FENCING



Must be placed every 50 m on electric fences alongside public roads.

Sku. 125590004



By 4



32



SET OF CROCODILE CLIPS



For connecting to an energizer or battery.

Sku. 125865



By unit



38

EARTH ROD WITH WIRE



Earth rod with connecting wire and earth line. Sku. 125891.

Sku. 125891



30 cm - By unit

100



EARTH ROD



Essential. Essential in order to return the current when an animal comes into contact with the wire.

Sku. 125890



1 m - By unit

10



LIGHTNING INSULATOR WITH SPRING



Lightning insulator. When the fence is struck by lightning, it directs the voltage surge generated to the earth and keeps the energizer safe. Your energizer warranty will not be applicable if the energizer has been struck by lightning. Lightning conductors are indispensable to protect your fences.

Sku. 125291



By unit

35



LARGE FENCE SWITCH



Isolator switch with insulated polypropylene body and stainless-steel connection. Can be used to switch off one section of the fence for maintenance while keeping the rest powered up.

Sku. 125293



By unit

Limited stock

90



FENCING BEAUMONT | Reels

SELF-INSULATING REEL



With brake and handle. Mounting holes for attaching to a 30 x 30 mm post (large model) or a 20 x 20 mm post (medium model). Attachment hook.

Sku. 125350 3 338020 032051

Medium model / 1 000 m of wire

Sku. 125352 3 338020 038206

Replacement spool medium model **Limited stock**



BEAUMONT EURO REEL



Plastic reel, spool attached with a pin. Reel can be locked with a hinged locking arm. Metal attachment hook.

Sku. 125343001 3 338020 076369

500 m of wire

BEAUMONT STANDARD REELS



Sku. 125361001 3 700393 965524

Large model 800 m of wire or 300 to 500 m of tape

Sku. 125361002 3 700393 965531

Medium model 500 m of wire or 200 to 300 m of tape



REEL



Reel system with 300 m of wire on the spool.

Sku. 125355017 3 388770 180175

Ø 17 mm - 300 m **Limited stock**

Sku. 125355024 3 388770 180243

Ø 24 mm - 300 m **Limited stock**

Sku. 125355026 3 388770 180267

Ø 26 mm - 300 m **Limited stock**

LARGE REEL WITH SLING



Pass the sling over your head and the reel will rest on the operator's stomach.

Sku. 125360 3 338020 026227

Large model / 1 000 m of wire **Limited stock**



Battery



BP60 - 12 A BATTERY



Clture électrique - Elektrozaun - Electric fencing

12 V, 60 A. Battery with indicator.
Rechargeable using a charger. Ideal for use with the solar charger kit.

Sku. 125090



By unit



Explore our range of Horizon TURBOMAX batteries (Sku. 125H12012, 125H14896, 125H14500...).

Testers

BEAUMONT 12 KV FENCE TESTER



Clture électrique - Elektrozaun - Electric fencing

Indicates the status of your fence via six voltage levels ranging from 2 000 to 12 000 V. Very easy to use.

Sku. 125012



By unit



BEAUMONT DIGITAL FENCE TESTER



Clture électrique - Elektrozaun - Electric fencing

This digital voltmeter is the classic measuring instrument. Easy to handle. Rapid testing.

Sku. 125427001



By unit





FENCING BEAUMONT | Nets





NON-ELECTRIFIED POULTRY NET

Non-electrified poultry net, height 1,12 m.

Sku. 125584225  3 700393 958007 

25 m

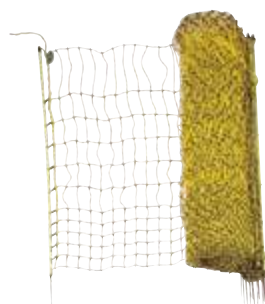

Sku. 125584250  3 700393 958014 

50 m



POULTRY NET, HEIGHT 1.12 M

Poultry net, height 1.12 m.

Sku. 125584  3 338020 043002 

50 m





FENCE POST FOR POULTRY NET

Post for poultry net. Height: 1.12m.

Sku. 125585002  3 338020 065424 



COPPER FERRULE

Sku. 125602  3 338020 011353 

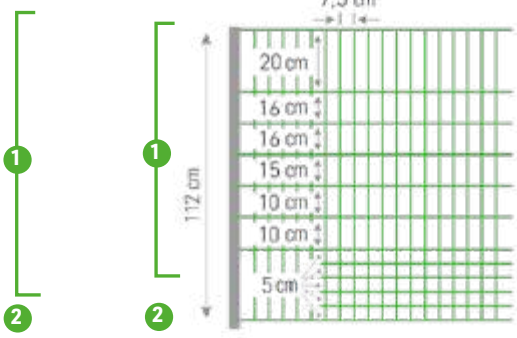

- 1 11 wires: Supporting wire: 3 x 5 monofilament, Ø 0.40 mm; conductor: 3 x 1 stainless steel, Ø 0.20 mm
- 2 1 wire: Supporting wire: 4 x 8 monofilament, Ø 0.40 mm

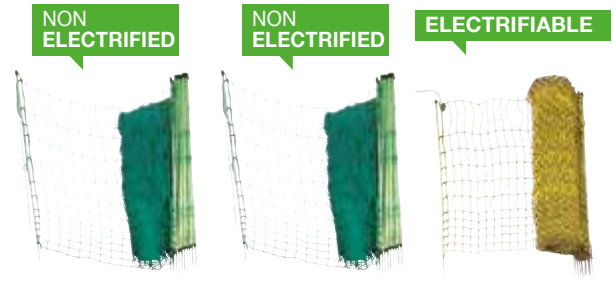

Technical characteristics	Sku. 125584225	Sku. 125584250	Sku. 125584
Length	25 m	50 m	50 m
Height	1.12 m	1.12 m	1,12 m
Electrified	Non	Non	Oui
Number of posts	9	15	15
Colour	Vert	Vert	Yellow
Quantity per pallet	66	45	40



CLASSIC SHEEP NET, HEIGHT 0.90 M



- Height: 0.90 m
- Length: 50 m
- Colour: Yellow
- Number of posts: 14
- **Electrified earth wire**

Electrified horizontal wires, non-electrified vertical wires. Each wire intersection is welded and is thus non-deformable and stronger.

Sk. 125582



50 m

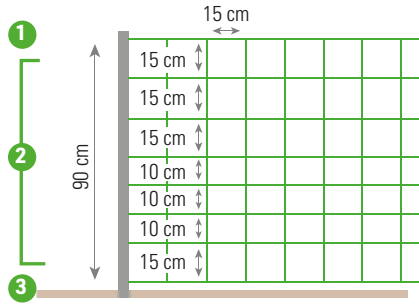

- 1 wire:** Supporting wire: 3 x 8 monofilament Ø 0.40 mm; conductor: 3 x 2 stainless steel Ø 0.20 mm.
- 6 wires:** porteur: 3 x 5 monofilament Ø 0.40 mm; conductor: 3 x 1 stainless steel Ø 0.20 mm.
- 3 wire:** porteur: 4 x 8 monofilament Ø 0.40 mm.

KOMBI SHEEP NET, HEIGHT 0.90 M



- Height: 0.90 m
- Length: 50 m
- Colour: orange and green
- Number of posts: 14

With struts. The struts keep the netting in place when the ground is uneven.

Sk. 125582001



50 m

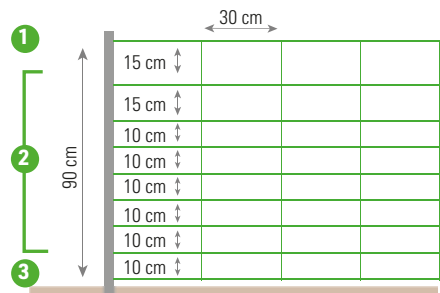

- 1 wire:** Supporting wire: 3 x 8 monofilament Ø 0.40 mm; conductor: 3 x 2 stainless steel Ø 0.20 mm.
- 6 wires:** Supporting wire: 3 x 5 monofilament Ø 0.40 mm; conductor: 3 x 1 stainless steel Ø 0.20 mm.
- 3 wire:** Supporting wire: 4 x 8 monofilament Ø 0.40 mm.

BORDER NET REINFORCED SHEEP NET, HEIGHT 0.90 M



- Height: 0.90 m
- Length: 50 m
- Number of posts: 14
- Colour: red

Red with white intermediate posts. **20% more conductive than other sheep nets.** Nets created for heavy users of nets (migratory farmers, mountain farmers).

Sk. 125582003



50 m

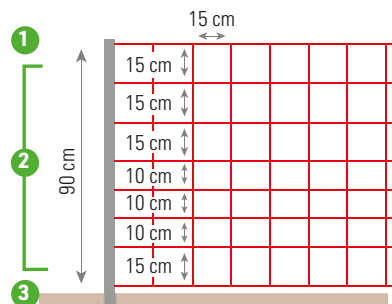
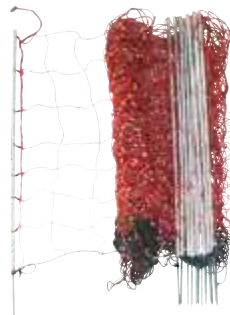

- 1 wire:** Supporting wire: 3 x 8 monofilament Ø 0.40 mm; conductor: 3 x 2 stainless steel Ø 0.25 mm.
- 6 wires:** Supporting wire: 3 x 5 monofilament Ø 0.40 mm; conductor: 3 x 1 stainless steel Ø 0.25 mm.
- 1 wire:** Supporting wire: 4 x 8 monofilament Ø 0.40 mm.

Technical characteristics	Sk. 125582	Sk. 125582001	Sk. 125586002	Sk. 125582003
Length	50 m	50 m	50 m	50 m
Height	0.90 m	0.90 m	0.90 m	0.90 m
Spikes	Single	Single	Double	Single
Struts	No	Yes	Yes	No
Colour	Yellow and White	Orange and green	Orange and green	Red and White
Quantity per pallet	77	66	66	77

FENCING BEAUMONT | Nets



BEAUMONT DOUBLE-SPIKE SHEEP NET



- Height: 0.90 m
- Length: 50 m
- Number of posts: 14
- With struts

The double spike ensures good stability in wet soil.

Sku. 125586002



50 m

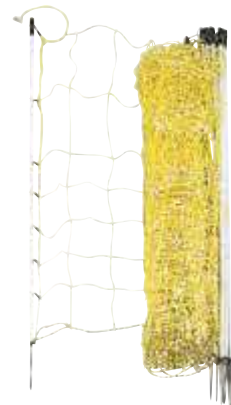

GOAT NET, HEIGHT 1.06 M



- Height: 1.06 m
- Length: 50 m
- Colour: Yellow
- Number of posts: 14
- **Electrified earth wire**

Electrified horizontal wires, non-electrified vertical wires. Each wire intersection is welded and is thus non-deformable and stronger.

Sku. 125583



50 m

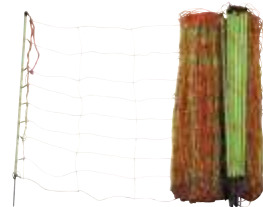

KOMBI GOAT NET WITH STRUTS, HEIGHT 1.06 M



- Height: 1.06 m
- Length: 50 m
- Colour: orange and green
- Number of posts: 15

Sku. 125583001



50 m



FENCE POST FOR SHEEP NET



Sku. 125585

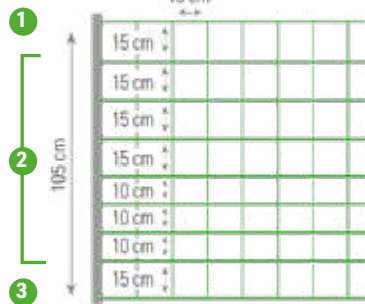

- 1 wire:** Supporting wire: 3 x 8 monofilament, Ø 0.40 mm; conductor: 3 x 2 stainless steel, Ø 0.20 mm.
- 6 wires:** Supporting wire: 3 x 5 monofilament, Ø 0.40 mm; conductor: 3 x 1 stainless steel, Ø 0.20 mm.
- 1 wire:** Supporting wire: 4 x 8 monofilament, Ø 0.40 mm.

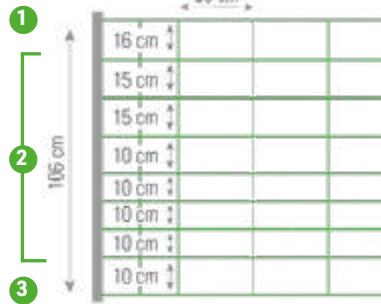

- 1 wire:** Supporting wire: 3 x 8 monofilament, Ø 0.40 mm; conductor: 3 x 2 stainless steel, Ø 0.20 mm.
- 6 wires:** Supporting wire: 3 x 5 monofilament, Ø 0.40 mm; conductor: 3 x 1 stainless steel, Ø 0.20 mm.
- 1 wire:** Supporting wire: 4 x 8 monofilament, Ø 0.40 mm.



FENCE POST FOR NET



Sku. 125585001



Goats



Sku. 125585003



Rabbits



RABBIT NET, HEIGHT 0.65 M

- Height: 0.65 m
- Length: 50 m
- Colour: Yellow
- Number of posts: 15

Sku. 125584001



50 m

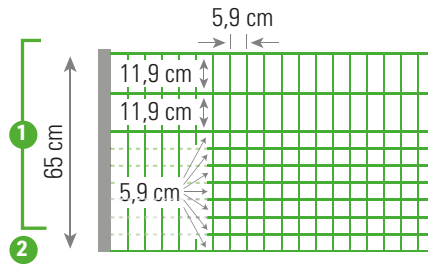
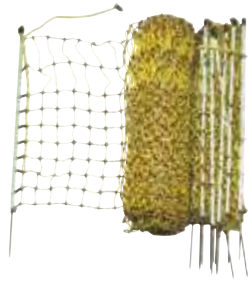

- 1 **9 wires:** Supporting wire: 3 x 5 monofilament, Ø 0.40 mm; conductor: 3 x 1 stainless steel, Ø 0.20 mm.
- 2 **1 wire:** Supporting wire: 4 x 8 monofilament, Ø 0.40 mm.



WOLF NET, HEIGHT 1.20 M

- Height: 0.90 m
- Length: 50 m
- Colour: Yellow
- 13 white fibreglass fence posts, integrated and very sturdy. Single spike: 6 x 90 cm-high posts and 7 x 120 cm-high posts with an insulator enabling a tape to be added.
- 8 electrified horizontal wires:
 - Upper wire: 24 monofilaments including a 6 x 20 mm stainless steel conductor
 - 6 rows of 15 monofilaments, including a 3 x 20 mm stainless steel conductor
 - Lower wire: 32 monofilaments including 4 x 20 mm stainless steel conductor.

Thanks to its extremely robust fence posts, the wolf net is easy to use and offers maximum protection for your flock or herd. Thanks to its extremely robust fence posts, the wolf net is easy to use and offers maximum protection for your flock or herd. The plastic braids are protected against UV. Each wire intersection is welded, ensuring high deformation resistance and optimum conductivity.

Sku. 125581100

50 m
Limited stock



We encourage you to find out about the measures currently in force concerning the protection of livestock from wolves in your region. You may be able to obtain subsidies to fund your equipment.

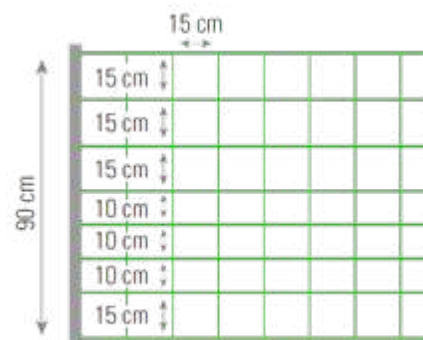

FENCING BEAUMONT | Practical guide

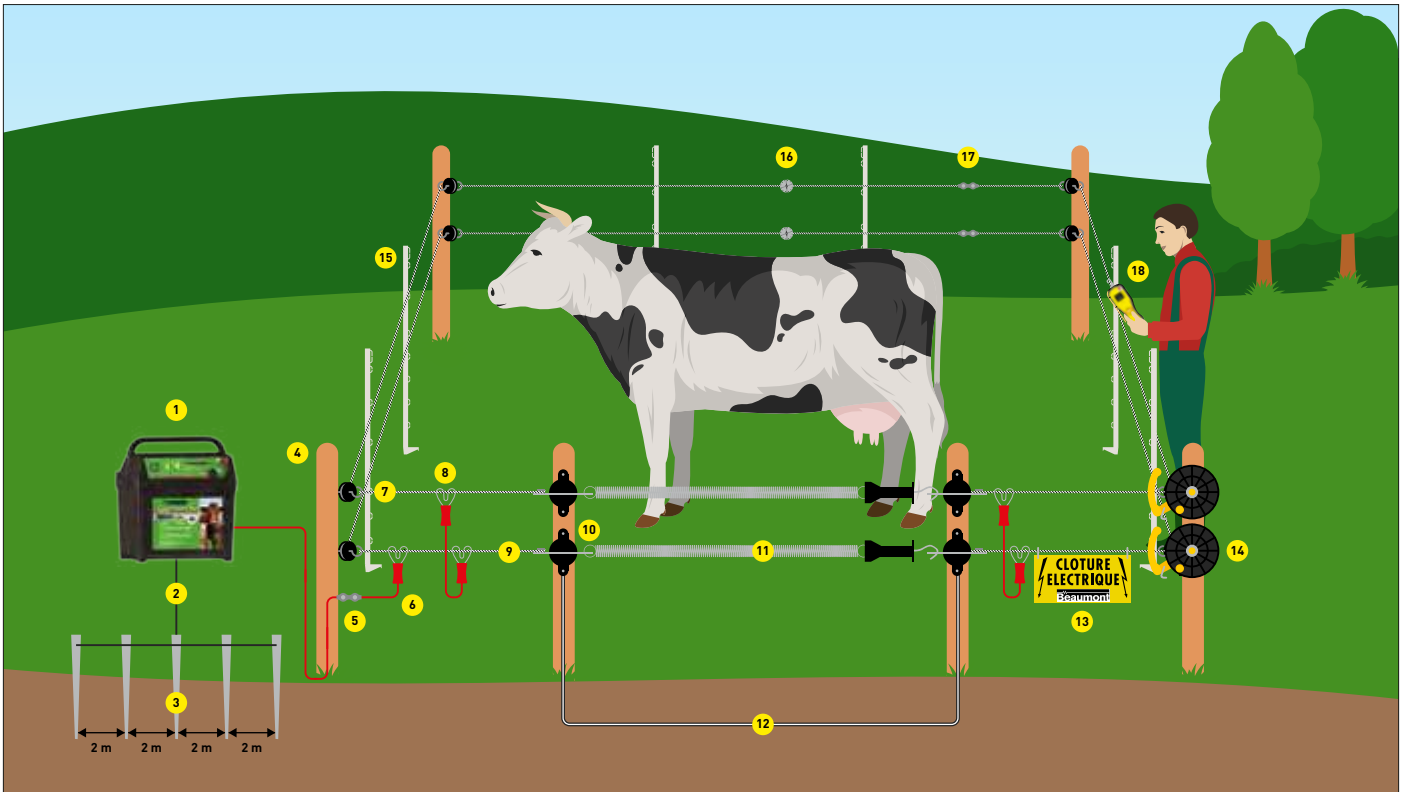

DIAGRAM OF MOBILE FENCING FOR COWS

- | | | |
|--------------------------|--------------------------------------|--------------------------|
| 1. Dual energizer | 7. Corner insulator for wire | 13. Warning sign |
| 2. Earthing wire | 8. Wire-to-wire connector | 14. Reel |
| 3. Earth rod | 9. Fence wire | 15. Plastic fence posts |
| 4. Wooden post | 10. Anchor insulator for wire | 16. Wire strainer |
| 5. Connector | 11. Gate kit with spring | 17. Connection for wire |
| 6. Fence connecting wire | 12. Direct-burial high-voltage cable | 18. Digital fence tester |

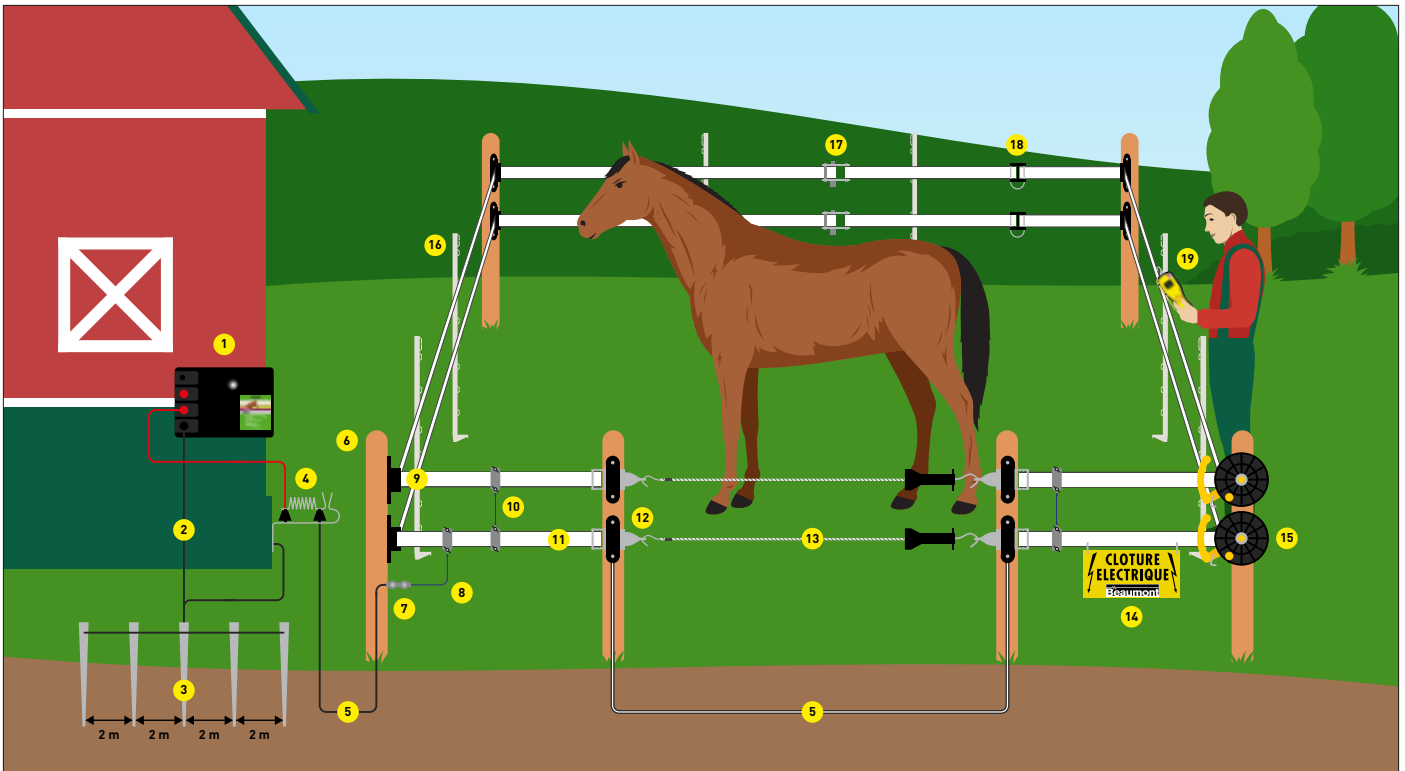

DIAGRAM OF MOBILE FENCING FOR HORSES

- | | | |
|-------------------------------------|--------------------------------|--------------------------|
| 1. Mains energizer | 8. Fence connecting wire | 15. Reel |
| 2. Earthing wire | 9. Corner insulator | 16. Plastic fence posts |
| 3. Earth rod | 10. Tape-to-tape connector | 17. Tape strainer |
| 4. Lightning conductor | 11. Fence tape | 18. Connection for tape |
| 5. Direct-burial high-voltage cable | 12. Anchor insulator | 19. Digital fence tester |
| 6. Wooden post | 13. Gate kit with elastic cord | |
| 7. Connector | 14. Warning sign | |

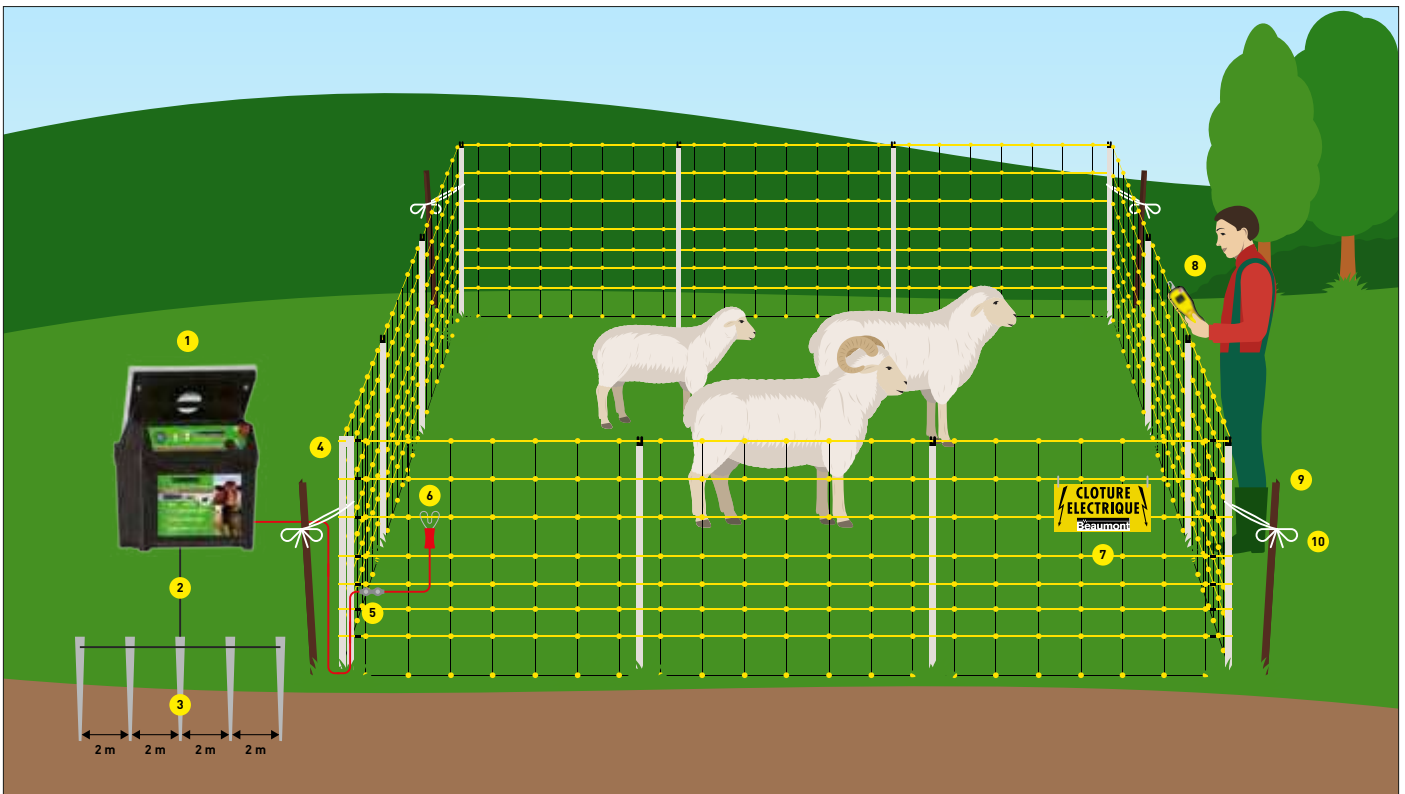

DIAGRAM OF MOBILE FENCING FOR SHEEP

- 1. Solar energizer
- 2. Earthing wire
- 3. Earth rod
- 4. Sheep net
- 5. Connector
- 6. Fence connecting wire
- 7. Warning sign
- 8. Digital fence tester
- 9. Corner post
- 10. Farmer rope

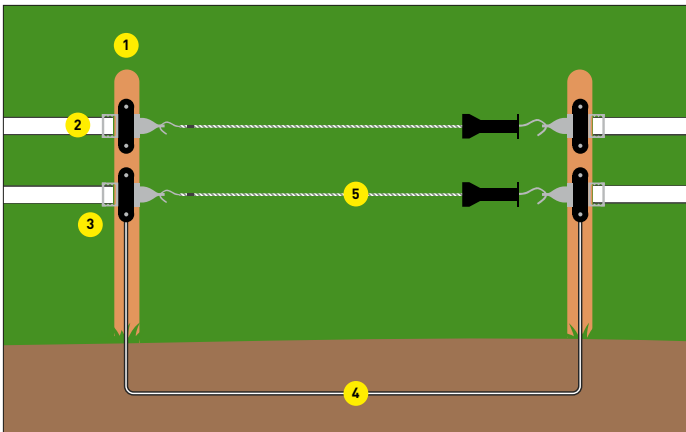
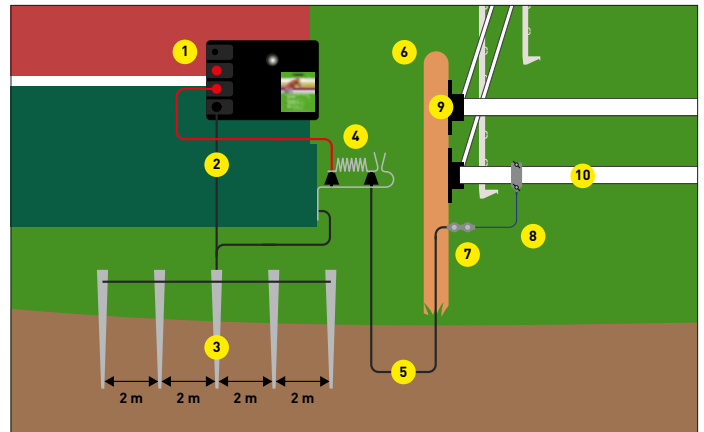

DIAGRAM OF GATE KIT

- 1. Wooden post
- 2. Fence tape
- 3. Anchor insulator
- 4. Direct-burial high-voltage cable
- 5. Gate kit with elastic cord



CONNECTION DIAGRAM FOR FENCE ENERGIZER

- 1. Mains energizer
- 2. Earthing wire
- 3. Earth rod
- 4. Lightning conductor
- 5. Direct-burial high-voltage cable
- 6. Wooden post
- 7. Connector
- 8. Fence connecting wire
- 9. Corner insulator
- 10. Fence tape



OUR ADVICE



TIP REGARDING THE BATTERY:

Take off the scotch tape to air the battery. Ideally, we recommend waiting a few minutes for the chemical reaction to take effect before activating the battery.

Place the battery in the energizer, making sure it is the right way round (red/red - black/black). Place some scotch tape back on the battery when storing it to extend its lifespan.

IN A FEW STEPS
ELEC
FENCING
CONDUCTORS
POSTES
DEVIS

"PLAN YOUR OWN MADE-TO-MEASURE ELECTRIC FENCING PROJECT!"



EASY



QUICK



EFFICIENT

MORE THAN
2000
COMBINATIONS!



OUR BRANDS:



DISCOVER OUR VIDEO!



www.ukal-elevage.com/en/fencecalculator

UKAL    



UKAL

—
**UKAL TECH
SELECTION**

- 202 Mocall
- 203 Luda Farm
- 206 Hotline
- 207 Lorentz



UKALTECH

UKAL TECH is the new branch of UKAL dedicated to technical and innovative products requiring support and advice from our experts. This division adapts to the specificities and constraints of breeders, their animals and their farms. Our aim is to meet their new expectations by offering expert and tailor-made solutions to improve production, the quality of life production, the quality of life of farmers and animal welfare. We focus on innovation and digitalization of farms. Do not hesitate to contact the dedicated team by phone or via their website www.ukal-tech.fr. Find here a selection of UKAL TECH articles.



MOOCALL HEAT

Moocall HEAT significantly reduce the time spent detecting and tracking heat cycles in your herd.

WORKS OF MOOCALL HEAT::

- Moocall HEAT is a collar that is worn by a stock or a teaser / vasectomised bull. Moocall eartags are attached to all cows and heifers. Delivered with 50 RFID eartags. The collar then uses cow/bull proximity, mounting behaviour and bull activity levels to determine to an extremely high level of accuracy when a cow or a heifer is in heat.
- Moocall HEAT sensors measure the bull's activity around the cows to determine which cows are in estrus and when. They will then send you an SMS message, an app notification and an email to let you know that they have detected mounting activity. You can then use the AM/PM rule if you are using a teaser bull to AI at the optimum time.

On average, you will need about 1 device per 50 head. Each collar comes with 50 tags. You can put up

Sku. M0034724 MOOCALL Heat  5 932000 117233



MOOCALL HEAT EARTAGS

For Moocall heat collars.

Sku. M00347241 By 25  5 932000 117226 

FARM CAM MOBILITY 4G



Through its 3G/4G connection and rechargeable battery you can place FarmCam Mobility wherever there is mobile network coverage. Works Anywhere - Anytime. FarmCam Mobility is the perfect surveillance solution in places where you don't have power or Wi-Fi connection. Thanks to the rechargeable battery and SIM-card, you can monitor your property, machines, animals, etc. in remote areas. **As long as you have mobile network coverage, you can setup the camera wherever you need it.** Used together with the SolarCharger FCM you will not even have to think about recharging the battery. In other words, a truly mobile surveillance camera. The Smart Motion Sensor will register and record activities that appears in front of the camera. When the camera registers an activity, you will be informed through a notification in your smartphone or by e-mail. By distinguishing warm objects from tree branches that move in the wind, rain, flies, etc. the Smart Motion Sensor eliminates false alarms and ensures you are alerted to genuine situations. Other useful features that come with the camera are Zoom, Night Vision, Alarm and Two-Way Audio (mic/speaker). If the camera detects trespassers, you can act by talking to them directly or scare them off by triggering the Alarm function of the camera.

Features:

- Use it wherever you have 3G/4G network coverage..
- Rechargeable battery, lasting up to 2 months depending on usage.
- SIM-card that automatically chooses the strongest network included. No settings needed: just Plug-n-Play.
- Rain/sun, day/night - place the camera wherever you want without worrying about the weather.
- Smart heat and movement sensor ensures you are alerted to genuine situations and eliminates false alarms.
- SD-card included for recording of motion events which you access through the FarmCam 2.0 App in your smartphone.

Sku. LUD1086	Farm Cam Mobility 4G		
Sku. LUD1091	Luda SolarCharger FCM		



Solar panel for LUDA FARMCAM MOBILITY 4G and 360S



NEW

CAMERA FARMCAM 360S



Motorized Wi-Fi surveillance camera with a 360° overview. FarmCam 360S is a mobile surveillance camera for both indoor and outdoor use that can cover 360 degrees. The camera has a 16x digital zoom and a 2560x1440 video resolution, which gives you razor-sharp images in Full QHD quality (almost two times sharper than Full HD). FarmCam 360S can be powered by 230V or a Luda.Farm solar panel during warmer months and sunshine, plus temporary with its built-in rechargeable battery when needed. The camera needs Wi-Fi/Internet access for set-up and to be able to view live video in the FarmCam 2.0 App on your smartphone and tablet. The App is free of charge. It has dual-band functionality, which allow users to operate on both the 2.4GHz and 5GHz frequency band for maximum speed and efficiency. FarmCam 360S has motion detection alarm and can record on the 32GB memory card (included) upon motion detection and sends you a notification in the App on your phone or tablet. You can pan, tilt and zoom the camera in the App. FarmCam 360S has night vision, alarm plus microphone and a speaker with talk-back function built-in the camera. In the FarmCam 2.0 app you can talk with the person in front of the camera or use a recording of your voice to scare off an intruder.

- 2560x1440 QHD video resolution
- Dual-band 2.4GHz and 5GHz functionality
- **Lens with a 122-degree field of view**
- Use your phone to easily rotate your camera

Sku. LUD1116	FarmCam 360S	
---------------------	--------------	--



farmCam 360



Additional camera



POWERBANK LUDA GM battery

* with subscription on LUDA website.

MACHINE CAM MOBILITY HD

LUDA FARM

NEW HD VERSION

The Machine Cam Mobility HD camera accompanies you throughout your working day with its new larger and better quality screen! Machine Cam Mobility HD is a truly portable technology: it can be carried like your smartphone. You now have a single video surveillance system per operator, instead of several cameras on different machines. The camera and battery are attached to the machine with powerful magnets. You don't have to worry, the whole thing won't fall down or move around. Moving it from one machine to another takes only a few seconds.

The Machine Cam Mobility HD comes in a sturdy case that's easy to carry, you'll find:

- The camera monitor with its HD screen + a monitor stand
One USB power cable + one 12V IGC adapter
Camera power cable
PowerBank 8700 + one charger
The Powerbank allows the camera to operate for 15 hours with a charging time of 4 hours. At the end of the day, plug in and charge the PowerBank battery directly from the case.
- The Machine Cam Mobility HD transmits video without interference via Wi-Fi.
- The camera and battery are waterproof, IP69K rated.
3-year warranty* (*Subject to product registration on LudaFarm website).
Translated with www.DeepL.com/Translator (free version). Need help choosing your camera? Let us help you by consulting https://ludafarm.typeform.com.

Sku. LUD1096

Machine Cam
Mobility HD
Limited stock



Sku. LUD1064

POWERBANK
LUDA GM battery
Limited stock



IP66 water proof	WIFI	+50° -20°	App Available on Google play App Store	Rec	Zoom
3 Year Warranty	85° Wide angle lens	Night Vision	Motion Alarm	FullHD 1080	Sound



FARM CAM IP2

LUDA FARM

FarmCam IP2 is a smart camera specially developed for farming FarmCam IP2 is the first smart camera, designed to work with the platform.

Delivering stunning HD video wirelessly to your phone, tablet, or computer, FarmCam IP2 packs an impressive range of features. Rugged, water-resistant design, motion detection and night vision, FarmCam IP2 is made for life on a farm. FarmCam IP2 can send alarms and notifications to the farmer, co-workers, and neighbours when it spots suspicious movement outside of normal working hours.

Key benefits:

- FullHD 1920 pixels.
- Watch live video in the My.Luda.Farm app on your phone, tablet, or computer.
- Connects through WiFi and installation takes just 10 minutes.
- Motion detection alarms sent to farmer, co-workers, or neighbours.
- Rugged, water-resistant design (IP66).
- The safety of knowing that your cameras watch your farm 24/7.

Sku. LUD1075

FarmCam IP2



LUDA FENCE ALARM



Luda.Fence is a fence guard that displays the voltage level of your electric fence right on your phone and warns you if the voltage suddenly drops. Luda.Fence can be used in any location with GSM coverage. Using your phone, you can now monitor your fence 24/7 year round. With the Alarm+ option, you will receive an alarm immediately in case the voltage drops in addition to a convenient voltage graph to help you determine whether the voltage drop is due to animals or shrubs/rain. These features are grouped in the same app as your other Smart Farming products to provide an instant overview of key areas on the farm right on your mobile phone. When combined with Luda.SmartPlug*, you can also switch the power to your fence on and off without having to go to the power supply when it is time for maintenance. (*SmartPlug requires an IP 20 protected environment.) Included in package: Luda.Fence fence guard, 220 V outdoor charger, Ground pin, 12 V outdoor charger, Fence clamp, Earth clamp, 3-year warranty.

Sku. LUD1072 Luda Fence Alarm 7 350030 453790



LUDA FARM SOLAR CHARGER



Luda.SolarCharger 3W - The solar panel that charges the battery for you! With the solar panel SolarCharger 3W connected to your FenceAlarm your battery will always be fully charged. This means that you no longer have to mount down and bring home your FenceAlarm unit for charging. Why not save time and energy using the sun rays? Natural energy at its best!

Sku. LUD1085 Luda Farm Solar Charger 7 350030 454551 20



SMART PLUG



The Luda.SmartPlug connects your electric equipment to the My.Luda.Farm app and turns ordinary machines into smart farm equipment. The Luda.SmartPlug connects through the normal phone network for complete coverage, free of charge, and comes equipped with a temperature sensor for an expanded range of functionality. Turn equipment on/ off from your phone or tablet, monitor temperature and power consumption in simple graphs. With the extended Control+ package the Luda.SmartPlug packs a range of advanced timer and climate control functionality. With the extended Alarm+ package you receive alarms when power fails, or when power or temperature moves outside your set alarm range. Save time and money by being able to fix problems when and where they happen. SmartPlug connects any electrical equipment to the My.Luda.Farm app. Turn your important electric equipment on/off using your phone, tablet or computer, wherever you are. Monitor temperature and power consumption in simple graphs directly on your phone. Receive alarms in your phone or by email when there is a power failure. Receive alarms when temperatures fall outside your set range or when they change very fast. Receive alarms when power consumption falls outside of your set range, combine monitoring functions with advanced timers, turn power on/off at sunset and sunrise, or in response to the room temperature. Please check the need of adaptors for your country Front Type F (Schuko) Backside Male Type E (French). **Subscription not included.**

Sku. LUD1071 Smart Plug 7 350030 453783 28





MEADOW PUMP KIT WITH SOLAR PANEL 60 W

Hotline
Electric Fencing

The complete meadow pump kit allows you to supply water to your pasture tank, avoiding water contamination by animal excrements but also stopping erosion of river and stream banks by cattle. An easy, reliable and autonomous way to provide water to livestock when watercourses are fenced off. This maintains water quality at a high level and preserves the healthy growth of local flora and fauna.

The complete prairie pump kit includes:

- 1 control box with compartment for 12V battery. **BATTERY NOT INCLUDED**
- 1 30 m hose with submersible pump
- 1 float switch
- 1 solar panel 60W INCLUDED

Its solar panel provides constant autonomy for this meadow pump kit. The polypropylene battery compartment is very weather resistant and can hold a 12V/85 Ah battery (not included). For optimal operation of your meadow pump, we recommend the use of an 85 Ah battery. Farmers increasingly need to keep their livestock away from waterways. The European Water Framework Directive (WFD) establishes a framework for the protection of inland waters, transitional waters (estuaries), coastal waters and groundwater. River fencing provides protection against bank erosion. Solar battery-powered meadow pump kits can be integrated into all common drinking troughs. The solar pump provides the animals with their water needs without having to change or recharge the battery (depending on storage density, weather conditions, etc.). These kits are simple 12 V pumping systems based on water pump technology to allow the transfer of large quantities of water. The kit is equipped with a float that activates the submersible pump when the water level drops. The pump is connected to a 30 m long hose that leads directly from the water source to the tank. The set is powered by a 12 V battery (not included in the kit) located in a weatherproof housing. We recommend an 85 Ah battery. The water requirements of the animals are very different and are influenced by temperature, humidity and type of feed, among other things. The majority of grazing animals are herd animals and want to drink together, so the size of the drinking trough should allow for this. By increasing the height, the pumping capacity is reduced. At a height of 10 m the pump is running at about 65% of its maximum performance. The charging times of the solar energy vary according to the weather conditions. Keep in mind that in summer the water needs of the animals increase. The water requirements are indicative. Make sure to follow the instructions for use.



Sku. 119150

Meadow pump kit with solar panel



FIND OUR VIDEO ON YOUTUBE

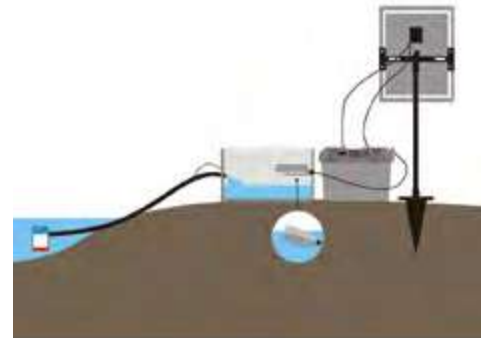
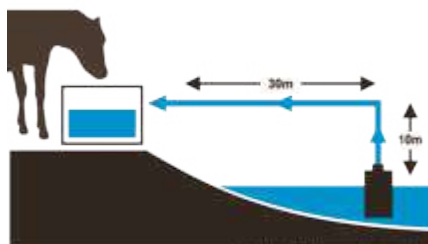

MEADOW PUMP KIT WITH HOSE AND FLOAT

Hotline
Electric Fencing

The complete Meadow pump kit includes: 1 control box with compartment for 12 V battery (battery not included), 1 30 m hose with submersible pump, 1 float switch.

Sku. 119150001 Meadow pump kit with hose and float 5 021385 008400



SOLAR PANEL 60 W WITH SUPPORT

Hotline
Electric Fencing

This 60W solar panel with support is suitable for the meadow pump kit. This element allows to gain autonomy and to ensure a permanent water supply in the pasture tank. A real economic gain!

- Highly efficient crystalline solar module
- Adjustable aluminium support
- Developed for connection to the meadow pump kit - without charge controller
- Dimensions: 685 x 670 x 35 mm

Sku. 119150002 Solar panel 60 W 5 021385 009971



BATTERY FOR MEADOW PUMP

Hotline
Electric Fencing

Battery ideal for meadow pump. Ready to use.

Sku. 119150004 85Ah (C100)
70Ah (C20) 4 250227 511414



SOLAR PUMPING KIT

LORENTZ

Discover our tailored solutions for pumping water in the field. This pumping kit is ready to use and easy to install. This basic kit is ideal for pumping water to a depth of up to 10 m **using only solar power**. It can be used in a borehole, a well, a tank or even a body of water (river, lake, etc.) The pump is powered by the sun, without batteries or any other energy source.

Kit contains:

- HR-07 high performance pump
- 2 100-W solar PV panels
- 1 controller
- 1 low water probe
- MPPT pump controller
- 2 plastic cable ties

Sku. 119150200 0-10m
Daily flow rate: 7000 L 3 700393 924484

Sku. 119150201 10-25m
Daily flow rate: 6000 L 3 700393 924743

Sku. 119150202 25-40m
Daily flow rate: 3 000 L 3 700393 924491



INDEX

A

Adhesive hoof tape 45
 Adhesive tape for films 144
 Aluminium cable 183
 Ankle straps 97
 Antifouling disc 79
 Anti-kick bar 27
 Applicator for calf weaners 25
 Applicator for eartags 96
 Applicator for pig rings 64
 Applicator for rubber rings 55
 Apron 170
 Artery forceps 9

B

Baling twine 130
 Battery 193
 Battery for meadow pump 207
 Bells 47, 48, 58, 59
 Blades 106
 Blanket for calves 7
 Block for harness 100
 Blocks for demotec easybloc 34
 Bloodless castrator 24, 54
 Bolus gun 20
 Boot cleaner 170
 Boots 171
 Boots remover 171
 Bottle holder drinking trough 86
 Bracket for bucket 10
 Braided wires and ropes 180
 Brooms 132, 133
 Brush for colostrum bags 15
 Brushes 44, 45, 46
 Buckets 12, 43, 75, 127, 128
 Bull rings 26
 Butcher knife 165
 Butter churn 155

C

Cables for fencing 183
 Cages 150, 151, 152
 Calf and sheep feeder 129
 Calf buckets 10, 12, 16, 17
 Calving gloves 168
 Calving gown 170
 Calving jack 6
 Calving ropes 6, 7
 Cameras 203, 204
 Cane 27
 Cannula for syringes 121
 Cannulas for hoofglue 35
 Carder 46
 Catch hook 55, 56
 Catheter 39
 Chain for dummies 12
 Clamp for wings 85
 Cleavers 163
 Clippers 104, 105, 112, 113
 Cohesive flexible bandage for compression 36
 Collars 31, 47, 59, 97, 98
 Colostrum bags 15, 52
 Colostrum feeder for lamb 52
 Colostrum scale 13
 Combs 108, 109, 110, 111, 112
 Connection cables for fencing 184, 185
 Connection for ropes and tapes 184
 Control cover 42

Cool spray for comb 115
 Coop 71
 Cow brush 46
 Cow lift 7, 8
 Cream separator 154
 CRESYL® 138
 Curry comb 45

D

Dairy 78
 Dairy brush 44
 Dehorning 21, 22, 23, 54
 Dehorning paste 23
 Dehorning pen 23
 Demotec 90, 95 34
 Detergent 172
 Disk filters 41
 Disposable overalls 169
 Disposable overboots 169
 Dosing cup 39
 Double tissues 38
 Drenching gun 120, 123
 Drenching syringe 121
 Drinker for chicken 77
 Drinking bowl 126
 Drinking trough 73, 75, 77, 78, 81, 86
 Dummies 11, 12
 Dutch bowl 17

E

Ear notcher 100
 Eartags 94, 95, 86
 Earth rod 191
 Egg candler 68
 Eggs (ceramic, wood..) 71
 Electric clippers 104, 105
 Emasculator 54
 Energizers 179, 181
 Ewespoon 50

F

Feeder for calf 10, 13, 14
 Feeder for lamb 51
 Feeder for poultry 72, 74, 75, 76, 79, 80, 82, 87
 Feeding cup 136
 Fence tester 193
 Fish oil 62
 Flashlight 144
 Flexi-tubs 129
 Fly bucket 146
 Fly tapes and strings 146, 147
 Foam dip cup 38
 Food slicer 159
 Food thermometer 161
 Forks 166

G

Gas cannon bird scarer 150
 Gas cartridge for dehorner 21
 Gate handle 188
 Gloves 168
 Glue 250 ml SEPTICARE II 35
 BOND EXPRESS XL 82
 Grain mill 162
 Grills for meat mincer 131
 Grip folding stool 64
 Guide paddle 64

H

Hairnet 168
 Halters 30, 31
 Hand sheep clippers 53

Handles 44, 132, 133
 Handles for fencing 189
 Handles for saw wire 23
 Harness for rams 100
 Hay rack 130, 134
 Hay rake 134
 Head gate for sheep 56
 Head lift 24
 Heating plate for chicks 68
 HEINIGER clippers 106, 113
 Hobbles 27
 Hoof checker 34
 Hoof cutter 32
 Hoof discs 32, 33
 Hoof glue 35
 Hoof knife 33, 57
 Hoof mat 17, 36, 37
 Hoof rasp straight with handle 32
 Hoof scraper 32
 Hoof shears 57
 Hoof tape 36
 Hoof tar 37, 147
 Hutch 85

I

Identification strap digits 98
 Incubators 66, 67
 Infrared protector 90
 Insect killers 144, 145
 Insulators 185, 186, 187, 188, 191
 Intravenous set 121
 Introducer for magnets 20
 IR protector 90

J

Jump cups holder 131

K

Kit for colostrum 15
 Knives 162, 164, 165

L

Lamb feeder 50, 52
 Lamb feeder bottle 52
 Leads 28, 29
 Leg splint for calves 36
 Lid for bucket 10
 Light bulbs 91
 Lubricating gel 8
 LUDA farm solar charger 205
 LUDA fence alarm 205

M

Magnet 20
 Magpie trap 150
 Manger 128, 129
 Marker 96
 Marking fluid 101
 Marking numbers 0-9 101
 Marking spray 99
 Marking stick 100
 Mastitis detection kit 39
 Meadow pump kit 206, 207
 with solar panel 60 w 157
 Meat mincer 24, 54
 Metal knee pad 43
 Milk cans 43
 Milk funnel & aluminium grills 43
 Milk sampler dipper 43
 Milk tank brush 44
 Milk thermometer 18
 Milk warmers 18, 19
 Milk whisks 19

Milking cup	39	Reactive liquid	39	Switch for fence	191
Milking grease	40	Rearing cage	69	Syringes	119, 120, 121, 122, 123
Milking pail	43	Reels	192		
MooCall calving sensor	6	Refractometer	13	T	
MooCall heat	202	Restraining ring	23	Tailwell mk2	105
Muzzles	18	Ropes	180, 182	Tank set for automatics guns	121
		Rubber rings	55	Transport cage	84
		Rubber tourniquet	23	Tape-rope connection cable	185
N				Tapes	180, 182
Needles	124	S		Tar bandage «certoplast»	36
Nesting boxes	71	Saddle rack	131	Tattooing ink	101
Nets	194, 195, 196, 197	Salt lick holder	130	Tattooing paste	101
		Sausage filling machines	158	Teat dip cup	38
O		Saw for bones	163	Teat for veals	10, 11, 12
Oil for milking machine	42	Saw wire for dehorning	23	Teats	10, 12, 11, 41, 51, 52
Overalls	169	Scalpel blades	62	Teats for lambs	51
		Scalpel handle	62	Thermal bag for colostrum bag	15
P		Scissors	9, 115	Thermic depilator	38
Pasteurizer	156	Scoops	135, 136	Thermometers	9, 68, 141
Pasteurizer for colostrum bags	15	Scrapers	135	Tips for dehorner	22
Peach teat	17	Scratchnall™ pad	64	Tomato mill machine	157
Pig catcher	63	Septiject	8	Tooth cutting nipper	63
Pig holder	63	Set of crocodile clips	191	Traps	148, 149, 150, 151
Pig nose rings	64	Shafts	133	Trimmers	110, 113, 114
Pigeon feeder	82	Sharpening paste	115	Trocar	20
Pine tar	37, 147	Sharpening stone	34	Trusti tuber	14
Pliers for fence	191	Shaving fork	133, 134	Twisted wires	180
Plucker	84	Shearing plant	107, 108		
Posts for fencing	194	Shears	53	U	
Posts for net	196	Shepherd leg crook	55	Udder towels	38
Poultry catcher	84	Shepherd stovel	56		
Poultry houses	69, 70	Shepherd's knife	58	V	
Poultry shears	166	Shovels	136	Vaccum machines	160
Powermite	64	Sleeves	170	Vacuum bags and rolls	161
Prolapse needles	8, 50	Smart plug	205	Valve for lamb teats	51
Punch pliers	47	Snap hook	143	Vaseline oil	115, 123
		Snares	148	Visitor's kit	169
Q		Solar panel 60 w with support	207		
Quarter milker	42	Solar pumping kit	207	W	
Quick link	143	Speedy drencher	13	Warning signs for electric fencing	191
		Sprayer	39	Washers	10, 42
R		Spring for anti-kick bar	27	Weaners	25
Rabbit drinking trough	86	Squeegee	135	Weasel box	151
Rabbit hoppers	86	Stablemate	134	Weightband	123
Rabbit killer	85	Staples for pigs	64	Wire connector screws	184
Rabbits trap	151	Stethoscope	9	Wooden blocks	35
Rain gauge	141	Strainer for wire, rope and tape	184	Wrapping set	58
Ram apron	56	Straps	97		



UKAL

THE WORLD OF LIVESTOCK

UKAL ELEVAGE

Parc économique de la Sauer
2 rue de l'Étang
CS 50244 Eschbach
67892 Niederbronn-les-Bains
France
Tél.: +33 3 88 07 40 15
ukatel@ukal.com
www.ukal.com

AFTER SALES SERVICES

sav@ukal.com
Tél.: 03 88 90 73 93

UKAL INTERNATIONAL

Tél.: +33 3 88 07 40 16
Fax: +33 3 88 07 40 14
export@ukal.com

ALLEMAGNE HORIZONT ANIMAL CARE

Homberger Weg 4-6
34497 Korbach
Germany
Tel.: +49 (0) 5631/565-100
agrار@horizont.com
www.horizont.com

UKAL CANADA INC.

7525 rue Pion
J2R 1R8
St Hyacinthe
Québec / Canada
Tél.: (450) 796-1414
Fax: (450) 796-1415
Sans frais: 1 800 665 8389
info@ukal.ca

POLOGNE ROLOS

Ul. Henryka Sienkiewicza 2
Wyszków
PL 07-200
Polska
rolos@horizont.com.pl
Tel.: +48 29 742 33 39
www.horizont.com.pl

SLOVÉNIE HORIZONT CLAIR D.O.O. TRGOVSKO PODJETJE D.O.O.

Zbilje 4 H
1215 SL - Medvode
Slovenien
Tel.: +386 (0) 1 3617 606
Fax: +386 (0) 1 3617 607
info@clair.si
www.agro-clair.si

ROYAUME-UNI HOTLINE ELECTRIC FENCING

Wharf Road
Newton Abbot
Devon TQ12 2DA
United Kingdom
Tel.: +44 (0) 1626 33 11 88
Fax: +44 (0) 1626 33 18 10
sales@hotline-fencing.co.uk
hotline.horizont.com



UKAL.com

UKALAGRI

