



UKAL

THE LEGACY OF A PASSION

2023 | 2024



[UKAL.com](https://www.ukal.com)



Livestock farming, the legacy of a passion

The world is changing.

Consumers' expectations and the farmers' concerns of have evolved, bringing about a slow but progressive shift in the farming sector and even throughout society as a whole.

We constantly adapt to these changes by offering new products. This more comprehensive offer is a response, of course, to the expectations of livestock farmers, but also to those of gardeners, hobby farmers and, at the end of the day, just about everyone else.

Confident in our expertise in the world of farming, we have constructed and segmented our offer in three main product lines - UKAL AGRI, UKAL GREEN and UKAL TECH - to continue to perpetuate our heritage whilst embarking on a new chapter in the life of our firm.

UKAL AGRI THE LIVESTOCK SPECIALIST

Because mankind will always need food, we will continue to advise and assist those generations of farmers and livestock specialists passionate about their profession.

Our mainstay since we were founded 57 years ago, the UKAL AGRI division has changed and adapted constantly over the years and will continue to be our core business. Our go-to partnerships with horizon, Heiniger and more than 48 other brands position us as an essential player on the livestock farming market. In our capacity as a specialist in livestock farming, we make a point of honour of always being innovative, offering value-for-money products that improve animal welfare and simplify the livestock farmer's day-to-day life.

Along with our After Sales Service, which can supply a great many spare parts and offers a repair service, it is our wish to extend the lifespan of the products that we sell.

UKAL.com

OUR KEY FIGURES



6000

PRODUCTS



56

BRANDS



103

COUNTRIES

UKALGREEN

**THE REASON FOR OUR EXISTENCE:
AN ALLIANCE OF EFFICIENCY AND
ENVIRONMENTAL PROTECTION.**

"Good for me, good for my garden, good for my animals, good for my home, good for the planet." This, in a word, is how we sum our ambitions for this new division.

Much more than a passing fad, the green economy has well and truly taken a dominant role in our company. To meet the expectations of private individuals, gardeners and farmers, it was high time for UKAL to embark on a strategy of diversification and propose a range that combines efficiency and nature.

The UKAL GREEN division wants to offer an answer to exacting consumers looking for products in line with their convictions. Ethical and eco-responsible, UKAL GREEN brings you quality products, made in France and Europe, which are also environmentally friendly.

Our product range will be broadened accordingly over the coming years, always adhering to this demanding course of action.

UKALTECH

**INNOVATION TO MEET
FUTURE CHALLENGES**

*The agriculture of tomorrow:
the evolution of our profession 2.0.*

Precision agriculture is becoming increasingly widespread, an irresistible trend. The farming world is changing and the sector is developing to keep step with technological progress. The UKAL TECH division focuses resolutely on the future and wants to offer its know-how and expertise to arable and livestock farmers.

With UKAL TECH we are adapting to the specifics and constraints of livestock farmers, their animals and their farms. To meet their new expectations by offering expert, bespoke solutions is our objective in order to improve production, the quality of life of livestock farmers and animal welfare. We are putting our money on agricultural innovation and digitalisation.

UKAL TECH will work on specific themes such as water management, a priority issue for farmers, and on specific fencing projects.

Our commitments

18 months ago we decided it was time to bring our livestock packaging into line with our CSR policies.

The world moves on and so do the regulations, and we have to keep up. Our goal is to eliminate plastic packaging whenever possible, opting for eco-designed solutions instead.

**THE FUTURE,
IT IS NOW
WE ARE
BUILDING IT**



Visuel non contractuel

DISCOVER SOME OF OUR ACTIONS:



■ BULK

We prefer to sell our products without packaging whenever possible.



■ ECO-FRIENDLY PACKAGING

Eventually, the majority of our plastic packaging will be replaced by 100% recyclable cardboard packs.



■ OPTIMISING OUR PACKAGING

We are also optimising our packaging as part of their redesign (saving shelf space on the shelf, cost savings, more products on your shelves).



■ COST/QUANTITY OPTIMISATION

Changes to certain types of packaging to optimise the cost of the product and packaging.



■ WORK INTEGRATION

To help us introduce the new packaging, we have brought in a local work integration social enterprise.

We will continue to work to improve the day-to-day lives of our the day-to-day lives of our customers and stakeholders.



UKAL

THE UKAL WEBSHOP

More than **6000** product references

More than **2000** spare parts available from our after sales service

Fast ordering **simply** by uploading an Excel file

Online **fence calculator**

Merchandising tools can be ordered

Store locator

with a listing of retail outlets

All safety data sheets are available on our website.

QUICK AND EASY
PLACE YOUR ORDERS
24 / 7!



CHECK OUT THE VIDEO
ON OUR WEBSHOP BY SCANNING
THIS QR CODE

CONTACT US
to get your login code!

Bio EUTRA

THE FIRST ORGANIC
MILKING GREASE!



Beeswax
ORGANIC



Sunflower oil
ORGANIC



100% NATURAL INGREDIENTS.
ORGANIC beeswax and ORGANIC sunflower oil.



Distributed by UKAL Élevage



UKAL
The world of livestock

www.ukal-elevage.com





SUMMARY

07	Cattle	185	Pest control
51	Sheeps	199	Bugs control
63	Pigs	207	Beaumont fencing
67	Heating	231	Horizont fencing
71	Identification	329	UKAL TECH selection
81	Electric clippers	339	UKAL GREEN selection
95	Vaccination & drenching		
103	Farm & stable equipment		
123	Milk & meat processing		
137	Poultry		
161	Horses		
177	Pet well-being		



— CATTLE

8	Calving
11	Care
12	Feeding
22	Magnets
23	Dehorning
26	Castration
27	Restraining
30	Leads and halters
33	Collars
34	Hoof Care
40	Dairy
46	Hygiene
47	Brushes
49	Bells



MOOCALL CALVING SENSOR

MooCall's calving sensors measure contractions and predict when your cows will calve. This non-invasive, tail-mounted sensor collects hundreds of pieces of data per second. It can accurately predict when your cow is most likely to calve by measuring tail movements triggered by labour contractions.

When the contractions reach a certain level of intensity, over a period of time, the sensor sends an SMS alert directly to your mobile phone, on average, 1 hour before calving.

DOES NOT WORK FOR HORSES.

THE ADVANTAGES OF MOOCALL - CALVING SENSOR:

- Connects easily with all networks and phones (GSM signal).
- No need for wifi, stations, router or extra batteries.
- Notification 1 hour before calving by SMS, email and App notification.
- Free application.
- One year warranty.

Non-invasive.

- Cost compensated with about 30 cows.
- Reduces calf and cow mortality.
- After-sales service available by various means.

After one year, an annual fee applies to keep the unit active. The annual fee for the second year is payable directly to MooCall HQ. Annual renewal covers 12 months of unlimited calving alerts, software updates, service and support. The customer can also extend the warranty for a second year. Please note that MOOCALL is not geolocatable.

Sku. MO034716



CALVING JACK BEEF CATTLE Vink

Pulling power **500 kg** (1'100 lbs). For corpulent suckling-cows. The 1,80 meter (5'4") tube provides an efficient support for calving even for very big calves. It is also suitable for hanging the calf upside down to clear out the respiratory tracts.

Sku. 101011



Pulling power: 500 kg



CALVING JACK DAIRY CATTLE Vink

Pulling power **300 kg** (660 lbs). Allows a higher freedom of action as well as a high tension and an alternate motion of the two straps. Made of stainless steel.

Sku. 101010001



Pulling power: 300 kg



VINK CALVING ROPES Vink

Made of nylon. Diameter of 12 mm (1/2"). Supplied in pairs.

Sku. 101104



Red and blue



COTTON CALVING KAMER ROPES WITH RING Vink

55 cm (27") long. Diameter 12 mm. Very soft. The cotton avoids shearing. Supplied in pairs.

Sku. 101105



White

NYLON CALVING STRAPS KAMER

Suitable for calving ropes. After placing the rope through the metal ring, the large strap can be fastened on the leg of the cattle. The strap avoids shearing. Supplied in pairs.



Sku. 101123 

Nylon assorted colors
Limited stock 

BLANKET FOR CALVES UKAL

For optimal strengthening of the calf's immune system in the days after birth. Prevents diarrhoeal diseases. Breathable and moisture-resistant fabric 3 layers of protection with insulation for a better comfort of the calf. Long and adjustable straps. Machine washable at 30° C. Pocket with velcro fastening on the right side for the use of heating pads (not included). Length: 72 cm.



Sku. 101130 

By piece

CALVING GLOVES

90 cm (35.5"). CE standard. 28 microns.

Sku. 101120 

Box of 50  



POLYETHYLENE CALVING GLOVES

These gloves protect against micro-organisms in accordance with directive 89/686/ECC on personal protective equipment. Single use only. For search, calving and autopsy. 90 cm (35.5"). CE standard. Box of 100. The most resistant! 28 microns.



Sku. 101116 

Box of 100 

EXAMINATION GLOVES WITH SHOULDER PROTECTION



Single-use examination glove. Covers the shoulder and armpit for a better fit. Does not slip down the arm. 100 % polyethylene, very resistant. Comes in a handy dispenser box. CE standard. 100 cm.



Sku. 10119001 

Box of 50 

NYLON CALVING ROPES WITH RING KAMER

Length: 43 cm (17"). Diameter 12 mm. Supplied in pairs.



Sku. 101106 

White 

PERLON CALVING CORD 2 M KAMER

Diameter of 7 mm. For calving. Available in several colours. Using different colours during the calving makes it possible to identify the legs and to adjust the traction according to the calving need.

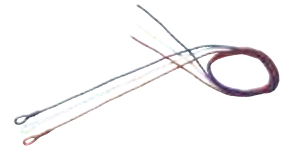

Sku. 101107036 

One blue and one red 

PROLAPSE HARNESS KAMER

It is used to keep the uterus in place in case of a prolapse. In leather.



Sku. 101110 

Leather
Limited stock



5 FINGER ORANGE CALVING GLOVES

92 cm (35.5"). CE standards: EN 374-1 (1994) and EN 420 (1994). One size.



Sku. 101117100 

Box of 100 

SEPTICARE CALVING GLOVES



87 cm (34.3"). Thin but strong. These gloves provide protection against micro-organisms in accordance with directive 89/686/EEC on personal protective equipment. Box of 100. 20 microns. Best quality-price ratio.



Sku. 101121 

Box of 100 

CATTLE | Calving



COW LIFT

KAMER

Suitable model for dairy and beef cattle. The clamps prevent injuries thanks to its rubber foam covering. Double thread and triple tubing for a better resistance. Very simple to adjust. Helps weak cattle to stand up (after a difficult calving, for deficient animals). Maximum weight: **900 kg** (1984 lbs).

Sk. 104453



Grey - Maximum weight
900 kg (1984 lbs)

NEW



COW LIFT



Cow lift robust and stable for cows up to **1500 kg**. A wise investment that pays off quickly and should be a "must" for every dairy farmer. An indispensable apparatus for cows that cannot get up. The clamps are adjustable to the size of every cow. With a pulley or a hoist you can help the cattle to get up.

Sk. 104456



Maximum weight
1500 kg



SEPTICARE LUBRICATING GEL



Lubricating gel ideal for lubricating the arms and hands for rectal and vaginal examinations.

Sk. 101212110



1000 ml . Spermicidal



NEW

ZINC OXIDE OINTMENT SPRAY



Spray-on zinc oxide ointment which protects the skin and allows it to regenerate naturally. This spray forms a barrier to prevent any risk of infection. Its properties allow the skin to retain its elasticity. External use only. Suitable for use on cats, dogs, horses, cattle, sheep, pigs and poultry. Complies with Directives 75/324/EEC and 2007/45/EC.

Sk. 002200



200 ml



NEW

ALUMINIUM SPRAY



The aluminium wound spray forms a protective film which allows the wound to breathe while keeping it clean. Suitable for use on cats, dogs, horses, cattle, sheep, pigs and poultry. External use only.

Sk. 002150



200 ml



NEW

BLUE SPRAY



A best-selling product! Use to clean wounds, bites and stitches. Suitable for use on cats, dogs, horses, cattle and pigs. External use only. Complies with Directives 75/324/EEC and 2007/45/EC.

Sk. 002100



400 ml

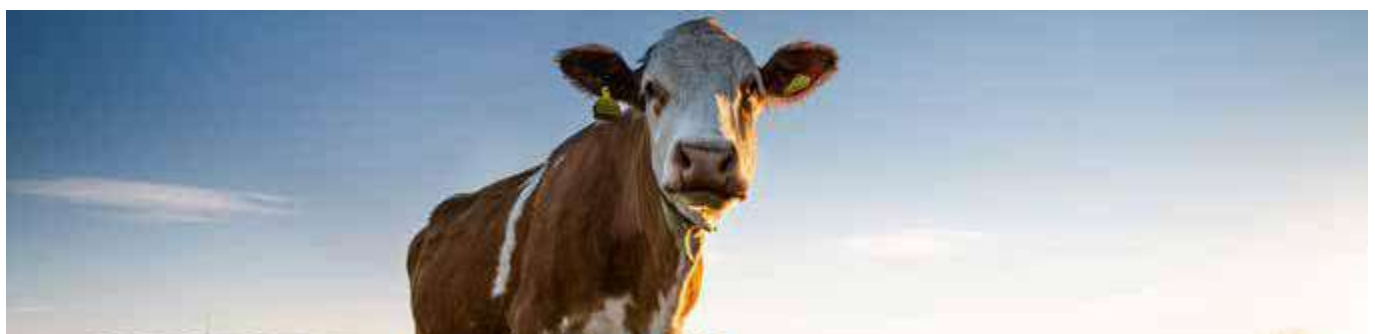



NEW

ELECTRONIC VETERINARY THERMOMETER WITH SIGNAL

UKAL

Digital display from 32°C to 43°C. Audible signal to indicate the temperature calculated.

Sku. 114062100 Electronic veterinary thermometer with signal   



LARGE DISPLAY THERMOMETER

UKAL

Digital display. Measuring time approx. 20 seconds. Measuring range: 32,0° C ~ 43,9 °C. Operates with one 3V lithium button cell battery (CR2032) included. Material ABS + TPE and stainless steel. Soft tip.



Sku. 114064 Assorted colors  



DIGITAL VETERINARY THERMOMETER

UKAL

Measurement from +32° C to +44° C with an accuracy of +/-0.1° C. Automatic shut-offn after 15 seconds. With suspension ring and cord. Supplied in blister pack with manual.

Sku. 114063 Digital veterinary thermometer  



STETHOSCOPE

With 22" (56 cm) PVC tubing. Y shape. Eartips made of polyethylene.

Sku. 114100 Assorted colors **Limited stock**  



UNIVERSAL SCISSORS MULTI-USE

KAMER

Very good cut multi-use: hair, bands, umbilical cord...



Sku. 114025 Multi-use  



ARTERY FORCEPS

KAMER

Used when suturing.

Sku. 114080 Artery forceps  



CATTLE | Feeding



FEEDING BUCKET 8 LITERS

Plastic feeding bucket is graduated. Very resistant. It is equipped with a sloping bottom so that all the milk is consumed. Supplied with handle, teat holder, teat. Food grade plastic, non-toxic. Hygienic, easy to clean. The transparent plastic version allows you to effortlessly check the level of remaining milk. Supplied without lid and bracket.

Sku. 120009630 

Transparent complete feeding bucket

Sku. 120009600 

Blue complete feeding bucket



TEAT HOLDER

With washers included.

Sku. 120009610 

Blue 

Sku. 120009612 

Grey 



TRANSPARENT LID

For TETIBLUE and TETICLEAR buckets.

Sku. 120009621 



METAL BRACKET FOR BUCKET

Sku. 120003004M 



CALF FEEDING BUCKET

Supplied without teat and teat holder. Food safe quality.

Sku. 120009632 

Transparent bucket

Sku. 120009601 

Blue bucket



COMPATIBLE TEAT

Work for TETIBLUE and TETICLEAR buckets. Length: 10 cm. High quality teats. **Box of 5.**

Sku. 120009635 

Red by 5 ; Shore 50 

Sku. 120009500 

Sand by 5 ; Shore 50 

Sku. 120009810 

Honey by 5 ; Shore 35 



WASHERS

Sku. 120009625 

By 5

Sku. 120009626 

By 100





FLOATING CALF DUMMY LARGE

The characteristic of this base is the ability to float with the teat oriented upwards. With its round form it is very steady and unsinkable. It has been specially designed for trough-feeding systems. The stainless steel washer ensures a perfect balance of the base. It is embedded in the valve and can't get in contact with the food. Cleaning and replacement of the base can be done easily and rapidly. Supplied with a teat 120009310.

Sku. 120009 

Diameter: 120 mm. 
Height: 130 mm



FLOATING DUMMY MEDIUM

The characteristic of this base is the ability to float with the teat oriented upwards. The double clamp ring avoids milk permeation, which ensures the sealing and the cleanliness of the base. It is very practical, easy to dismantle and to clean due to its special design. The calf is able to drink all the milk contained in the bucket.

Sku. 120009001 

Diameter: 80 mm. 
Height: 130 mm



SINKING DUMMY

After the milk bucket is filled, this base sinks to the bottom of the bucket. The teat of this sinking base remains constantly facing upwards, thanks to the inclusion of a stainless steel ring in the centre of the valve. The replacement of the teat is practical and quick.

Sku. 120009002 

Diameter: 75 mm. 
Height: 130 mm



FLOATING CALF DUMMY SMALL

The characteristic of this base is its ability to float with the teat facing down. The plastic part does not contain a balancing element, which forces the calf to look for the teat from the sides. It is extremely practical and easy to disassemble for cleaning.

Sku. 120009003 

Diameter: 74 mm. 
Height: 130 mm



NEW



SPARE TEAT

Colour: Red. Compatible with all floating dummies TETIBLUE except Sku. 120009. Shore 42. By 3.

Sku. 120009210 

Diameter: 43 mm. 
Height: 92 mm



NEW



SPARE TEAT

Colour: Sand. Diameter of hole: 3 mm. Compatible with floating dummy Sku. 120009. Shore 50. By 3.

Sku. 120009310 

Diameter: 46 mm. 
Height: 120 mm



NEW



SPARE TEAT

Colour: Sand. Compatible with all floating dummies TETIBLUE except Sku. 120009. Shore 50. By 3.

Sku. 120009120 

Diameter: 43 mm. 
Height: 92 mm

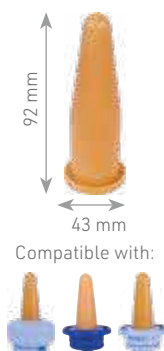

NEW



SPARE TEAT

Colour: Sand. Size: 45 x 100 mm. Compatible with all floating dummies TETIBLUE except Sku. 120009. Shore 50. By 3.

Sku. 120009130 

Diameter: 45 mm. 
Height: 100 mm



CATTLE | Feeding



NEW



ALUMINIUM CALF DUMMY

Aluminium. Shore 50. Sand color. Supplied in pairs.

Sku. 120007004 

Spare teat for aluminium dummy by 4 

Sku. 120006 

Aluminium calf dummy x 2 

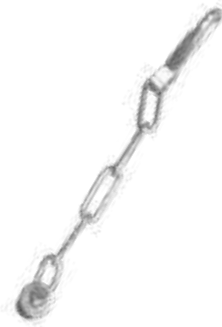

STAINLESS STEEL CHAIN

Sku. 120007006 

By unit



NEW

SMB CALF TEAT

They prevent leaking and assure a good flow so that the calf can suck without any difficulties. The «SMB» teat is suitable for all feeders with a 22 mm teat hole and also for the calf feeding bottle. Supplied in pairs.



Sku. 120038025 

SMB calf teat, by 25 



LATEX TEAT

For calf buckets and feeders.

Sku. 120005 

Latex teats reinforced x 2 



SEMI-CIRCULAR PLASTIC BUCKET WITH LID 6 L

The collar ensures that there are no losses. Very good stability thanks to its flat back. This new model has a metal reinforcement around the lid for a better stability of the handle. Supplied without teat.

Sku. 120015 

6 L 

Sku. 1200241C 

Rubber calf teat by 2 



CIRCULAR PLASTIC CALF BUCKET 7 L

Plastic calf bucket, circular, 7 L. The cone shape allows full flow of milk. To be placed on a circular support for the feeding box. Supplied with: valve, 2 rubber teats (Sku. 1200241C) without support.

Sku. 120001 

7 L

Sku. 120020 

White valve by unit



NEW



PLASTIC CALF FEEDER

With handle and teat. Food safe plastic. 250 ml scale. Supplied with rubber teat Sku. 120025. Sand colour. Possibility to adapt the teat for grains.

Sku. 120025001  3 338020 054084

2 L complete (bottle + teat)

Sku. 120035001  3 338020 087198

3 L complete (bottle + teat)

Sku. 120025002  3 700393 980756

Sand teat. Length: 10 cm. Supplied by 2 

Sku. 120025006  3 338020 068906

2 L bottle holder in metal

Sku. 120035006  3 338020 085705

3 L bottle holder in metal



SPEEDY FEEDER

The speedy feeder is a 3 speed calf feeding bottle. The **3 speeds** control the air inlet to the bottle. A teat is mounted low in the cap to empty the bottle contents completely. **THE ORIGINAL!** Graduation every liter.

Sku. 120050  9 417027 034283

2,5 L

Sku. 120056  9 417027 200923

4 L

Sku. 120055  3 700393 912177

Lid and teat SPEEDY FEEDER 



SPEEDY DRENCHER

The **original** Speedy Drencher is a drenching bottle for calves with the same characteristics as the Speedy Feeder bottle: 3 feed rates, ergonomic handle, a bottle neck with large opening and a wide base for greater stability. The lid and the drenching probe are suitable for the Speedy Feeder bottle. The length of the probe is 48 cm. Great for colostrum.

Sku. 120090  9 417027 200961

4 L

Sku. 120091  9 417027 177232

SPEEDY drencher tip



COLOSTRUM SCALE

Helps to evaluate the quality of the colostrum.

Sku. 124062  3 700393 923173

With test tube



ANTAHI COLOSTRUM REFRACTOMETER



Helps to evaluate the quality of the colostrum. Refractometer with automatic temperature compensation between +10° C and +30° C. Scale from 0 to 32 Brix.

Sku. 124070002  9 421904 214583

Colostrum refractometer



UKAL'S TIP

The colostrum refractometer: what importance does it have for newborns? Newborns don't have antibodies in their blood, which is a critical factor for the running of the immune system. Colostrum contains large quantities of antibodies and is the main source for the new born. Colostrum reduces the risk of diarrhea and pneumonia and saves lives. Refractometers allow you to verify that the milk given to the new born is healthy. Did you know? Colostrum is the milk produced by the female mammals at the end of the gestation, it is the first milk consumed after delivery.



Based in the heart of New Zealand, Antahi develops innovative and efficient products. The best start = optimum health and productivity for life. Through our hands-on experience we know how to achieve this best start for your animals and we are here to help farmers and vets achieve top results in a kinder, easier, safer and easier manner, through better equipment. Why Antahi? An = animal and Tahi = first in Maori. If you look after your animals, they will look after you. Our products are designed to work with the animal, achieving the lowest stress and the greatest result, which in turn makes a farmers work and life easier.

NEW

TRUSTI TUBER



Designed by a vet, the Trusti Tuber significantly reduces calf stress and discomfort. Flexi Tuber can be held in place with one hand. Large 4 liters capacity bottle. Transparent flexible tube makes it easy to clean and monitor flow. Ergonomic bottle handle. Perfect for large and small hands. Reliable valve. Fast flow even with thick colostrum. Shown in trials to almost halve procedure feeding time. Stopper and calf size markers provide easy guide for tube placement and positioning. **Attachment included with Flexi Tuber for use without hands.** Locking ring and calf weight indication for better positioning of the flexible tube (20 to 140 kg). Delivered with a teat for an easy transition between bottle and drenching.

Tip: Never let the liquid drain before the tube is placed in the esophagus.

Sku. 120095001	TRUSTI TUBER 4 L		
Sku. 120096001	FLEXI TUBER 4 L		



NEW

ANTAH FEEDER WITH TEAT



A specially designed bottle for both bottle feeding with the Antahi Suckle Up cap, and tube feeding with the Antahi Tubers. What makes a bottle a better bottle? Well that depends on the user, in this case the farmers and calf rearers, so we asked them: What would you like in a bottle and what makes your job easier? The Antahi Feeder is the result. High quality valve for reliable flow and no leaks. 4 liters or 1 gallon size for less refilling. Wide cap for eas filling and easy cleaning. Clip-on mouthpiece for maintaining hygiene. Ergonomic design for both small and large hands. Broad base for uneven ground.

Sku. 120097	4 L		
--------------------	-----	--	--



COLOSTRUM BAGS ANTAHI

Large spout for easy filling and cleaning. Transparent side – see the colostrum contents, see the colostrum level reduce during feeding. Reusable – due to durability and easy to clean design, the Trusti colostrum bag is the only colostrum bag designed to be reused. (Number of uses dependant on cleaning and care of bag). Comfortable handle. Pasteurisation friendly. Large capacity – **four liters freezes flat**. Quick thawing. Incorporating premium Trusti Tuber and Flexi Tuber oesophageal tube feeders.

Sku. 120098100 

Box of 10 

Sku. 120098500 

Box of 50 



COMPLETE KIT FOR COLOSTRUM ANTAHI

Kit containing colostrum bags, a peach teat and a trusti tube.

Sku. 120095100 

4 bags + teat + trusti tube 

Sku. 120095200 

10 bags + teat + trusti tube 



BRUSH FOR COLOSTRUM BAGS ANTAHI

Allows an efficient cleaning of the colostrum bags.

Sku. 120098 

Stainless steel 



PASTEURIZER FOR ANTAHI COLOSTRUM BAGS

This pasteurizer is specially designed for pasteurization of colostrum bags. Easy to use, very precise and good value for money. This pasteurizer makes it easy to pasteurize colostrum in Trusti bags, it can keep the number and quality of antibodies in colostrum and avoid bacteriological contamination. 60° C = ideal temperature for pasteurizing; for 60 min. 42° C = temperature for defrosting. Heating: depends on the degree of water. Cooling: approx 30 min. The technical characteristics: Plastic material. Capacity: 2 bags of 4 liters at the same time Water capacity: 27 liters. Digital screen.

Sku. 120098300 

Pasteurizer for colostrum bags **Limited stock**



THERMAL BAG FOR ANTAHI COLOSTRUM BAG

Insulated bag to keep colostrum warm when feeding or transporting.

Sku. 120098400 

Thermal bag for colostrum bag 





Since 1984, STALLION, a New Zealand company, has been designing, manufacturing and distributing watering solutions for farms. Mobile and robust, the watering troughs are made of 100% recyclable polyethylene and offer optimal UV protection. The STALLION brand uses Peach Teats, which are recognised throughout the world for their innovative technology that promotes the well-being of the calf by guaranteeing optimal feeding.



NEW

COMPARTMENTS CALF FEEDER

The Milk Maid series features a range of compartmentalized pen feeders available from 1 to 10 teat models. They are made of tough, durable plastic with rounded edges to make it easy for transporting and cleaning. Complete with steel brackets and screw in peach teats, they are easy to take off to ensure a hygienic clean.

Sku. 120018103 

MM3 - 3 peach teats - 16 L

Sku. 120018105 

MM5 - 5 peach teats - 25 L

Sku. 120018106 

Méga MM5 - 5 peach teats - 40 L

Sku. 120018110 

Méga MM10 - 10 peach teats - 66 L



NEW

CALF FEEDER WITHOUT COMPARTMENTS

Stallion's range of pen feeders have been thoroughly tested and proven to effectively feed calves from first day through to weaning. A must for every calf rearer. Non-compartmentalized pen feeders. Easy to install with galvanised steel hooks. Feeding troughs very robust and stable.

Sku. 120018200 

RFC1 - 1 peach teat - 6 L

Sku. 120018300 

BKT - 3 peach teats - 10 L

Sku. 120018115 

FC5 - 5 peach teats - 30 L

Sku. 120018111 

FC10 - 10 peach teats - 80 L



STEP 1

CHOOSE THE CAPACITY

6 L • 10 L • 16 L • 25 L • 30 L
40 L • 66 L • 80 L

STEP 2

SELECT THE TYPE OF COMPARTMENT

- calf feeder with compartments
- calf feeder without compartments

DISCOVER OUR NEW RANGE OF CALF FEEDERS

Choose the product adapted to your needs in 2 steps.

NEW

THREADED PEACH TEAT

The Peach Teat allows no more fluid to pass through it than a cow's udder naturally would, allowing the calf to suckle more intensely than conventional technology. This stimulates the flow of saliva and improves the PH-level in the stomach and leads to better digestion. Peach Teats are manufactured from a natural rubber specially developed to meet the needs of calf rearers, ensuring that the teats feel natural and comfortable to the calf, and will eliminate mouth ulcers. Peach Teats will pull through, or screw-on, all standard calf feeders. Peach Teats can be used for tube or gravity feeding using any container with a hole size of 22mm (7/8").



Sku. 120018405 9 421903 180087

Black - By 50

Sku. 120018404 9 421903 180070

Pink - By 50

Sku. 120018414 3 700393 929540

Pink - By 10

Sku. 120018410 3 700393 982682

Black - By 5



DUTCH BOWL 16 L



Sku. 122010 3 338020 079391

Capacity: 16 L.
Diameter: 36 cm



DUTCH BOWL 14 L



Sku. 122011 3 338020 079407

Diameter: 32 cm.
Capacity: 14 L



GRADUATED CALF PLASTIC BUCKET



Reinforced bottom. With handle. Liters graduation. The real capacity is at least one liter over the indicated graduation. On special request and for a minimum of 500 pieces you can choose the colour and the buckets can be personalised with a logo or with other advertising labels.

Sku. 122013 3 338020 050321

Capacity: 14 L. Grad. 12 L

Sku. 122014 3 338020 050314

Capacity: 16 L. Grad. 14 L

Sku. 122015 3 338020 050307

Capacity: 16 L. Grad. 15 L

Sku. 122018 3 338020 050338

Capacity: 19 L. Grad. 18 L



DID YOU KNOW?

Customised personalization service is available. Do not hesitate to contact us for more information.

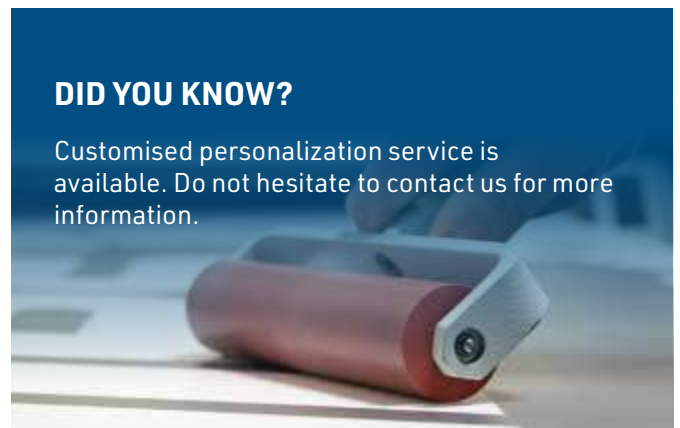

CATTLE | Feeding



CALF MUZZLE WITHOUT STRAP KAMER

White muzzle for calf without bridle. Very robust.

Sku. 120011



Grey in high density polyethylene



LARGE RIGID MUZZLE KAMER

Large model muzzle for fattening calves (heavy breed). Diameter: 18 cm.

Sku. 120011002



White, high density polyethylene
Limited stock



WHITE CALF MUZZLE WITH STRAP KAMER

In nylon.

Sku. 120012



White



MILK THERMOMETER IN PLASTIC CAGE

Temperature range from -10°C to 120°C. Easy to clean.

Thermometer suitable for cooked meats, milk or wine. Comes with a patented white polypropylene, foodsafe protective sheath. Special patented hook for height adjustment. The thermometer and its sheath can be sterilised in a dishwasher. Mercury-free thermometer.

Sku. 124061



Milk thermometer



TEFLON MILK WARMER

This teflon warming milk offers a great thermal power: 2300 W. Optical display in operation. Thermostat for continuous adjustment. Constant temperature: the device turns off automatically. Do not burn the milk. Protection against projections. High stability. Easy to clean. Waterproof IPX7. Operational from 150 mm level. Helps heat the milk and maintain its temperature. Large exchange surface to facilitate heating. Waterproof device and anti-adhesive.

Sku. 120400



In teflon



ALUMINIUM MILK WARMER

To heat the milk and to keep its temperature. Large heat exchange surface to make heating easier. Tight device. Waterproof. High stability.

Sku. 120300



In aluminium



POWERHEAT HORIZONT MILK HEATER 

Heats up the milk in a minimum of time. Reduced energy consumption. Easy temperature control. Flat heating element with fast heat dissipation. Patented and innovative design enables easier cleaning of the heating element and all parts which come into contact with milk. Indicator light and audible signal when the desired temperature is reached. Automatic shut-off feature against overheating of milk. Ergonomic handles and control panel. Aluminium. Stable and waterproof (IPX7). Ideal for use in calf feeders with 8L capacity. Applicable from 150 mm immersion depth. Ergonomic working height at 90 cm. Ø: 165 mm. Low weight: 2,8 kg.

Sku. 120500 Aluminium  4 014803 307569



DIGITAL POWERHEAT MILK HEATER 



Heats up the milk in a minimum of time. Reduced energy consumption. Easily adjust temperature by the degree. Flat heating element with fast heat dissipation. Saves the last temperature. Patented and innovative design enables easier cleaning of the heating element and all parts which come into contact with milk. Indicator light and audible signal when the desired temperature is reached. Automatic shut-off feature against overheating of milk. Ergonomic handles and control panel. Stable and waterproof (IPX7). Ideal for use in calf feeders with 8L capacity. Applicable from 150 mm immersion depth. Ergonomically working height at 90 cm. Ø: 165 Reduces germ formation, protects animal health. **Digital display easily readable in bad lighting conditions.** Teflon PTFE coating.



Sku. 120600 Teflon  4 014803 307576





MILK WHISK



Sku. 124070036 Stainless steel milk whisk and handle 35 cm  3 338020 042340  13

Sku. 124070037 Stainless steel milk whisk and handle 40 cm  3 338020 044511  50

Sku. 124070042 Stainless steel whisk-short wooden handle 40 cm  3 338020 057283  50





RUMINAL MAGNET IN PLASTIC CAGE KAMER

Very powerful magnet that prevents accidents due to the ingestion of foreign metal bodies. The cage's shape provides maximum protection and enables sharp metal pieces to stay in an optimal position. Length: 100 mm To be used with the magnet introducer Sku. 111019.

Sku. 111001  3 338020 008674

Single unit

Sku. 111001012  3 700393 910500

Box of 12 



RUMINAL MAGNETS KAMER

Very powerful magnet that prevents accidents due to the ingestion of foreign metal bodies. To be used with the magnet introducer Sku. 111019. Dimensions: 15 x 55 mm.

Sku. 111002  3 338020 008681

Box of 6 

Sku. 111003  3 338020 050000

Box of 12 



METAL INTRODUCER FOR MAGNETS KAMER

Nickel plated. Retains magnet while guide is being placed.

Sku. 111019  3 338020 008698

Length 55 cm - Inner diameter: 35 mm 



MULTI BOLUS GUN KAMER

Stainless steel with aluminium handle which guarantees a good grip. Allows you to introduce 2 magnets or 2 boluses at the same time.

Sku. 111050100  3 700393 963247

Length: 46 cm
Head diameter: 25 mm
Head length: 75 mm 



BOLUS GUN KAMER

Stainless steel. It retains the magnet while placing the guide.

Sku. 111050026  3 338020 056231

Diameter: 26 mm - metal spring 



ROUND CATTLE TROCAR KAMER

Trocar to pierce the stomach in case of bloating. To be used when the stomach tube is not effective.

Sku. 111114  3 338020 008766

Length: 22 cm, diameter 9 mm (for cattle) 

Sku. 111116  3 338020 008780

Length: 12 cm, diameter 6 mm (for sheep) 

THE 4 R'S OF DEHORNING

The Right moment

As soon as possible and before 4 weeks: the younger the calf, the easier it is to handle. At this age the veins are found just under the skin.

The Right restraint

A calf that does not move makes dehorning easier for the farmer. This represents 80 % of a successful dehorning.

The Right technique

The Right technique Clip first to properly locate the horn. Cauterise in 10 seconds without pressing too hard. Make a furrow of 4-5 mm. Cauterisation is not burning.

The Right pain management after dehorning

Apply a cleaning spray that cools the cauterisation. We recommend using Septiject (ref 002007). Treat against flies. Keep under careful observation for the next 48 hours. Avoid putting animals outside in wet weather.



WHY DEHORN?

For practical reasons:

- Easier access to the fence
- Save space
- Safe Handling

For safety reasons:

- Avoid accidents with the breeder
- Avoid accidents between animals

For economic reasons:

- A damaged skin decreases profitability

Different methods proposed:

- Electric or gas iron



GAS DEHORNER



Wireless, the NETHORN gas dehorner offers a run time of ± 2 hours. Thanks to its power of 350 W and its speedy rise of temperature in less than 2 minutes, this dehorner allows dehorning in 3 seconds per horn. The NETHORN dehorner has no exposed flame and has an automatic piezo ignition for starting up which can be changed without tools in a few seconds. It is a safe device in wet conditions, it can work in all positions and down to -10° C. Lightweight 770 g. 19 mm diameter nozzle supplied, **2 propene / propane / butane cartridges included**. Also works for goats (nozzle not supplied).



Sku. 103016



Supplied with 2 cartridges



GAS CARTRIDGE



Sku. 103016100



60 g propene/propane/ butane



ARKOS GAS CARTRIDGE FOR CATTLE

Gas cartridge for dehorner.

Sku. 103015446



60 g Butane, propane, propene



Sku. 103401556



340 g Butane, propane



ARKOS GAS DEHORNER FOR CATTLE



The pistol Grip - new model. Lightweight: 470 g. No cable/Portable. Works with gas cartridge Sku. 103015446. Built-in Piezo ignition. Temp.: 700° C / 1292° F, Max temp. reached in less than 3 minutes. Safety: Lock position. Operation position. Easy to handle: Non-slip dual-material handle. Pistol shape for good grip handling. Support stand. Reversible tip internal Ø 17 and 19 mm, to best adapt to various calf breeds. Additional tip internal Ø 15 mm available on request. Self-maintenance: change the trigger/ Piezo-ignition and gas nozzle without tools.



Sku. 103015144



Supplied with 1 cartridge





COSMOS DEHORNER

The Cosmos electric dehorner, with its Ø 16 mm tip specifically designed for cattle, is battery-operated making it very mobile and enabling the dehorning of up to 40 animals before recharging. Thanks to its mobility, animal restraint is greatly simplified and ensures total respect for animal well-being. Featuring numerous technological innovations, such as its closed circular heating wire and its built-in charge indicator, it helps operators save time and enables work in complete safety. Dehorning is made simple, with no more endless rotations. Always ready for use, it heats up and cools down almost instantly. With its unique patented system, it stops automatically when the 10-second dehorning cycle is complete. This guarantees quality dehorning for breeders, who know as soon as the operation is finished.

Sku. 103017200	On mains		
-----------------------	----------	---	---



SAROS DEHORNER

Fast, powerful, simple. Ecological innovation: less power consumed for more heating power. Lightweight and ergonomic handle: protection of the user's hand against the risk of burns.

- Fast: <5 minutes to heat up.
- Powerful: > 600 °C.
- Lightweight: 360 g handle.
- Cable length: 4 m.
- Low voltage: 24 V.
- IP68 transformer: allows working in wet areas.
- 17 mm tip.
- 2 years warranty.



Sku. 103018	On mains		
--------------------	----------	---	---



COMPLETE ELECTRIC DEHORNER 24 V UKAL

For calf dehorning. Dehorner tip goes up to 600°C. Supplied complete with a 24 V transformer. Built-in iron holder. 4 m power cord. Power 250 W. Tip of 17 mm diameter included.



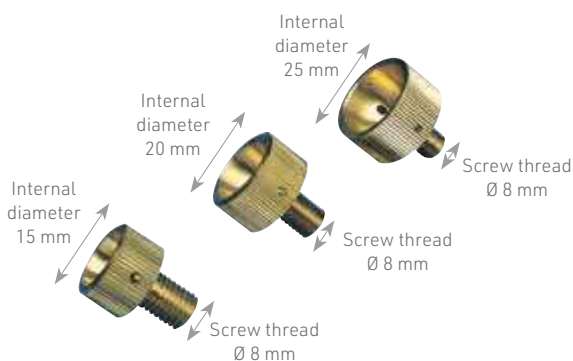



Sku. 103290100	24 V	
-----------------------	------	---



TIPS FOR DEHORNER



For dehorner sku: 103301001.

Sku. 103302015	Diameter 15 mm Limited stock		
Sku. 103302020	Diameter 20 mm Limited stock		
Sku. 103302025	Diameter 25 mm		

MECHANICAL BARNES DEHORNER

For cutting through the horns of calves. Metallic handle. Not for use on calves over 6 weeks.

Sku. 103307002 

Diameter 13 mm **Limited stock** 

Sku. 103307003 

Diameter 17 mm **Limited stock** 



DEHORNING PASTE



For the dehorning of calves younger than 3 weeks. In a syringe with scale. Corrosive substance, to use with caution. Consult the instructions for use.

Sku. 103306 

45 g 



DEHORNING PEN

For the dehorning of calves younger than 3 weeks. Corrosive substance, to use with caution. Please follow the instructions.

Sku. 103305 

8 g 



DEHORNING SAW KAMER WIRE

For the dehorning of adult cattle and embryotomy. This wire is extremely resistant. To be used with the dehorning saw wire handles, ref. 103312.

Sku. 103311 

12 m 



SWEDISH DEHORNING SAW WIRE

For the dehorning of adult cattle and embryotomy. Veterinary quality.

Sku. 103310 

10 m 



RESTRAINING RING FOR CALF KAMER

Galvanised steel. Fastens with 2 pins onto the vertical tube of a fence. The aim is to immobilise the head orientation of the calf whose snout is engaged inside the ring. Supplied with a rope.

Sku. 103315 

Galvanised steel

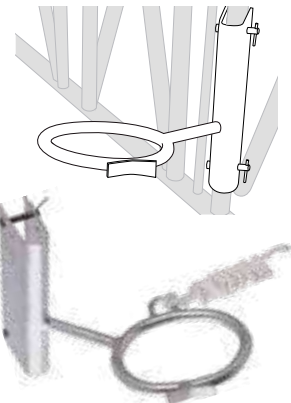

DEHORNING SAW KAMER WIRE HANDLES

To be used with ref.103311, or with ref. 103310. Antislip grooves. Supplied in pairs.

Sku. 103312 

Supplied by 2 



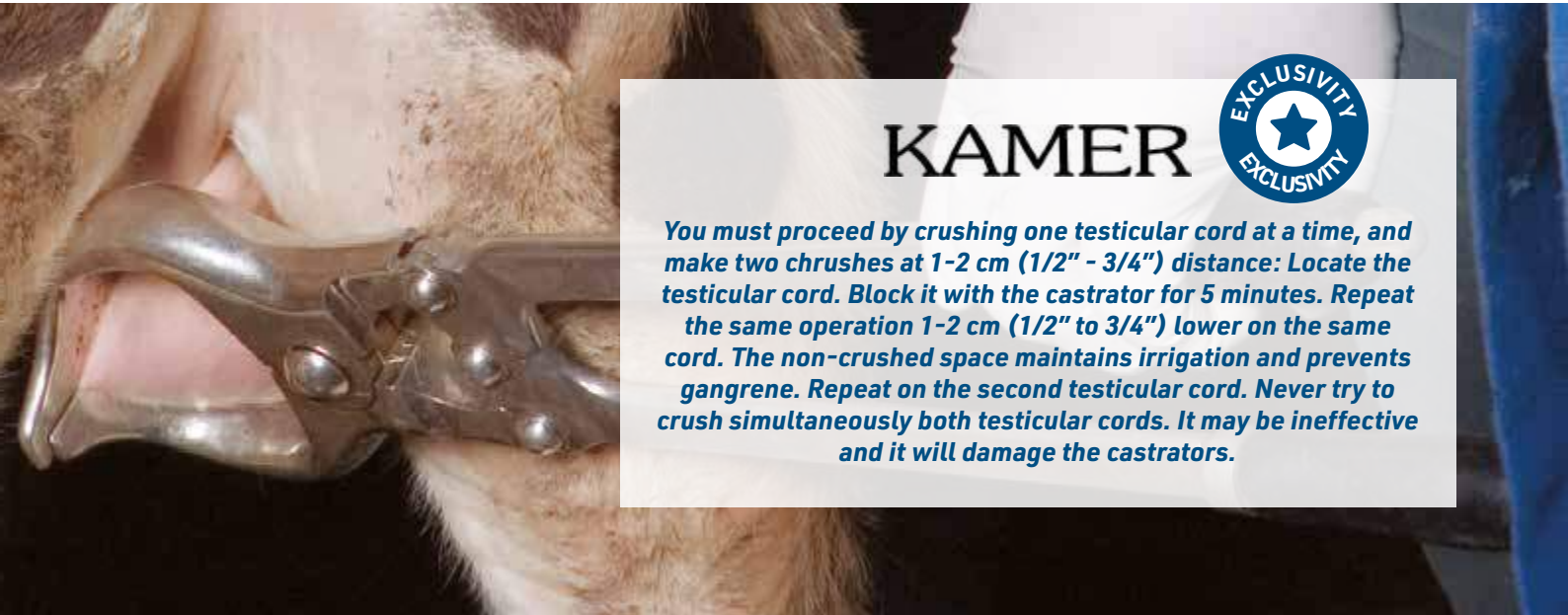

KAMER

You must proceed by crushing one testicular cord at a time, and make two crushes at 1-2 cm (1/2" - 3/4") distance: Locate the testicular cord. Block it with the castrator for 5 minutes. Repeat the same operation 1-2 cm (1/2" to 3/4") lower on the same cord. The non-crushed space maintains irrigation and prevents gangrene. Repeat on the second testicular cord. Never try to crush simultaneously both testicular cords. It may be ineffective and it will damage the castrators.

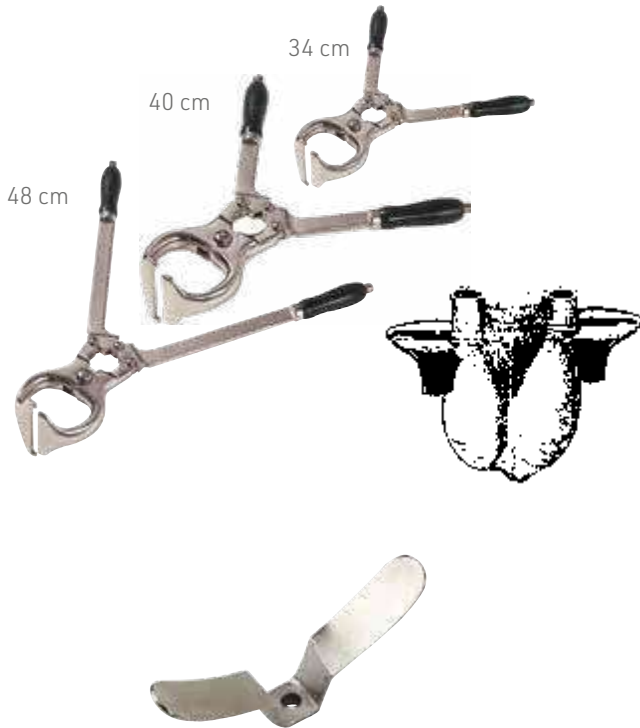

BLOODLESS CASTRATOR

KAMER

Articulated with closing stop. Made of high quality forged nickel-plated steel. Supplied with a tightening key. The castration can be performed as soon as the testicles have reached their final firmness (not their final size) and within the first 6 months. The bloodless crushes the testicular cord through the scrotum skin. After use and cleaning the castrator must be stored opened.

Sku. 102223035	34 cm	3 338020 001460	
Sku. 102223040	40 cm	3 338020 001477	
Sku. 102223048	48 cm	3 338020 001484	
Sku. 9102223048CLE	Tightening key	3 700393 939280	

METAL KNEE PAD

KAMER

Suitable for all the different bloodless castrators.

Sku. 102224	Metal	3 338020 001491	
--------------------	-------	-----------------	--

Restraining



VINK HEAD LIFT

Vink



It helps to position the head of the animal parallel to its body. In this position the animal is unable to move and it facilitates swallowing without wasting the drenching products or the mineral and vitamin supplements.

Sku. 104500	VINK head lift	8 719558 130931	
--------------------	----------------	-----------------	--

SPIKED KAMER SWINGARM CALF WEANER

Sturdy aluminium weaner with adjustable screw and butterfly adjustment nut. For a semi permanent implementation. The most popular weaner.





Sku. 104441  3 338020 002146
Aluminium   48



CALF WEANER KAMER WITH SPRING ADJUSTMENT AND SPIKES

Aluminium calf weaner with aluminium disc and spring adjustment. Quick and easy to install and remove. With spikes.





Sku. 104439001  3 338020 034123
Aluminium   84



METAL SUCKING KAMER PREVENTOR RING



For long term use. Available in 4 sizes: Weaner size, Calf size, for calves up to 5 months. Heifer size, for calves between 5 and 24 months. Adult size, for adult calves (older than 2 years).



Sku. 104440000  3 338020 054008
Weaner size x 5   84

Sku. 104440001  3 338020 031481
Calf size x 5   74



Sku. 104440002  3 338020 031498
Heifer size x 5   48

Sku. 104440004  3 338020 052080
Adult size x 2   40

APPLICATOR FOR KAMER CALF WEANERS

Double sided: the front is used to attach the weaners. The back is to detach the weaners. Anti-slip handle.



Sku. 104440  3 338020 931474
Calf weaner applicator  20

PLASTIC KAMER ADJUSTABLE CALF WEANER WITH SPIKES



Practical, efficient, economical. Weaner with screw adjustment. Avoid nasal injuries. For calves and small animals. Sold in pack of 2, 5 or 12.







Sku. 104446000  3 700393 927065
Small model x 2   64

Sku. 104446100  3 700393 930836
Small model x 5   30



Sku. 104200000  3 700393 959592
Petit modèle x 12   20

Sku. 104446001  3 700393 923258
Medium model x 2   64

Sku. 104446101  3 700393 930829
Medium model x 5   30

Sku. 104201001  3 700393 959585
Medium model x 12   18

Sku. 104446002  3 700393 927096
Big model x 2   40

Sku. 104446102  3 700393 930812
Big model x 5   28



HOW TO CHOOSE THE SIZE OF THE WEANER?



MODEL	Weaner	Calf	Heifer	Adult
AGE	Birth	up to 5 months	5 to 24 months	More than 24 months
REFERENCES	104 440 000	104 440 001	104 440 002	104 440 004
		104 446 000	104 446 001	104 446 102
		104 446 100	104 446 101	104 446 002
		104 200 000	104 201 001	104 202 002



BULL HOLDER HARMS KAMER

The two balls provide a perfect grip in the nose. **Length: 19 cm.**

Sku. 104412  3 338020 001811

Nickel-plated forged steel  

Sku. 104412S  3 338020 058402

Stainless steel  
Limited stock



BULL HOLDER WITHOUT CHAIN KAMER

Very robust bull holder. Supplied without chain. With two holes which allows use of a tightening rope. **Length: 20 cm.**

Sku. 104416001  3 338020 035076

Nickel-plated forged steel  



BULL HOLDER KAMER

For a fast animal capture. Handle length: 44 cm.

Sku. 104414  3 338020 041930



Steel 



BULL HOLDER WITH SPIRAL SPRING KAMER

Allows quick catch and release. Anti-panic system. Very robust. **Length: 17 cm.**

Sku. 104413  3 338020 001828

Chrome plated forged steel  



NICKEL-PLATED STEEL BULL RINGS KAMER

Self piercing bull rings. No applicator needed. Flat opening of the arches. The indicated diameters are the internal in mm. Supplied with break off screw.

Sku. 104420050	Ø 50 mm	 3 338020 039067		
Sku. 104420060	Ø 60 mm	 3 338020 001866		
Sku. 104420070	Ø 70 mm	 3 338020 001873		
Sku. 104420080	Ø 80 mm	 3 338020 001880		
Sku. 104420090	Ø 90 mm	 3 338020 001897		
Sku. 104420100	Ø 100 mm	 3 338020 001903		



BRASS BULL RINGS KAMER

Self piercing bull rings. No applicator needed. Flat opening of the arches. The indicated diameters are the internal ones and in mm. Supplied with break off screw.

Sku. 104421050	Ø 50 mm	 3 338020 039074		
Sku. 104421060	Ø 60 mm	 3 338020 001910		
Sku. 104421070	Ø 70 mm	 3 338020 001927		
Sku. 104421080	Ø 80 mm	 3 338020 001934		
Sku. 104421090	Ø 90 mm	 3 338020 001941		
Sku. 104421100	Ø 100 mm	 3 338020 001958		

CANE

KAMER

Plastic. Assorted colors.

Sk. 104402101



Ø 25 mm.



98 cm

ANTI-KICK BAR UKAL

Very robust and adjustable Anti-kick bar. Supplied in a box with rubber ends and springs. Recommended for every breeder! It is the safest, easiest, most efficient and most humane way to avoid kicks. Immobilizes both sides and keeps the animal calm during examinations or all other handlings.

Sk. 104409



Zinc - Supplied in a carton box



Sk. 104409001



Zinc. Supplied assembled - Supplied without box



NYLON HOBBLE KAMER TRIPLE ADJUSTMENT

Nylon hobble with an adjustment at the strap and another one at the legs. Very high quality.

Sk. 104411100



Blue



ANTI-KICK BAR US MODEL

KAMER

Very robust. Hand crank to adjust the opening.

Sk. 104410



Anti-kick bar



TOP RANGE STAINLESS STEEL ANTI-KICK BAR

Professional quality! 2 years warranty. New system to close quickly. Ref. 9104451R (by 1) or 104448 (by 2).

Sk. 104409010



Stainless steel



ANTI-KICK BAR KIT

KAMER

For the articles 104 409 and 104 409 001.

Sk. 104449



2 springs and 2 rubber ends. Black. 6 mm



Sk. 9104450E



2 rubber ends. Blue and red. For sku. 104409010



Sk. 104450



Rubber ends by unit



REPLACEMENT SPRING FOR ANTI-KICK BAR

KAMER

Sk. 104451006



By 6. Diameter: 6 mm



Sk. 104451009



By 6. Diameter: 9 mm



Sk. 104448



By 2. For Sku. 104409010



MATCHING:

SPRINGS	HOBBLES
104451009	104409
104451009	104409001
9104451R (X1) ou 104448 (X2)	104409010
9104451R (X1) ou 104448 (X2)	104409020





CORDERIE PALUS

Nestling in the heart of the Corrèze countryside, Corderie Palus, the family-run rope making firm, has become a reference, over the years, in mechanically- and hand-made rope. Since 1908, the Palus artisanal long rope making firm has been renowned for its age-old know-how that combines tradition and modernity. It has managed to maintain its traditional expertise while taking on board more modern production methods, always attentive to the needs of its market. This comprehensive understanding of the entire manufacturing process guarantees a high level of quality in production and finishing made in France.

— PPTEx LEADS



PPTex is a hemp-like synthetic fiber. This fiber is rot-proof and floats. PPTex is a real revolution in the world of rope: you benefit from a quality rope with a natural appearance without the usual inconveniences of hemp (odor, premature wear, etc.). Available in several sizes and diameters. Sold by 12.



Sku. 121115001V 

Length: 2,50 m. Diameter: 12 mm.  

Sku. 121116001V 

Length: 2,50 m. Diameter: 14 mm.  

Sku. 121117001V 

Length: 4 m. Diameter: 14 mm.  

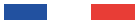

— PP LEADS





Polypropylene is a synthetic material that is rot-proof and anti-UV treated. Assorted colors; Available in several sizes and diameters. Sold by 12.



Sku. 121113002 

Diameter 12 mm - 1,5 m  

Sku. 121000000 

Diameter 12 mm - 2 m  

Sku. 121116002 

Diameter 16 mm - 3,5 m  









— PP/SISAL LEADS



Available in different sizes. Sold by 12.

Sku. 121115V Length: 2 m. Diameter: 12 mm   

Sku. 121116V Length: 2,5 m. Diameter: 14 mm   

Sku. 121116003 Green Length: 3,5 m. Diameter: 16 mm   

Sku. 121113001 Orange Length: 1,5 m. Diameter: 8 mm   

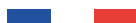

SISAL LEADS



Sisal is a natural fiber from the Agave (agave sisalana) and is particularly strong. It has a very wide range of applications thanks to its good resistance and its neutral smell. Natural, ecological and biodegradable. Available in several sizes and diameters. Sold by 12.

Sku. 121116004			
Diameter 16 mm - 3,5 m			
Sku. 1211113			
Diameter 8 mm - 1,5 m			
Sku. 1211114			
Diameter 8 mm - 2 m			



HEMP - PP LEADS



Sold by 12.

Sku. 121112101			
Diameter 10 mm - 2 m			
Sku. 121112102			
Diameter 12 mm - 2 m			
Sku. 121112103			
Diameter 14 mm - 2 m			
Sku. 121112104			
Diameter 16 mm - 2 m			

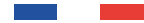

HEMP LEADS



Hemp is a natural fiber that is glued and polished using the same traditional methods of mechanical rope making since 1908. The advantages of hemp are numerous: Very good grip, does not burn. Heat and abrasion resistant. Low elongation. 100 % biodegradable. Available in several sizes and diameters. Sold by 12.

Sku. 1211112	Diameter 8 mm 2 m			
Sku. 121112001	Diameter 10 mm 2 m			
Sku. 121112002	Diameter 12 mm 2 m			
Sku. 121112003	Diameter 14 mm 2 m			
Sku. 121112004	Diameter 16 mm 2 m			

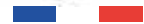

PPTX HALTERS



PPTex is a hemp-like synthetic fibre that is rot-proof and odourless. Supplied by 12.

Sku. 121110001V	Length: 3 m. Diameter: 12 mm			
------------------------	---------------------------------	--	--	--



CATTLE | Halters



PP HALTERS



Polypropylene is a synthetic material that is rot-proof and resistant to the weather. Sold by 12.

Sku. 121110003	Blue white Diameter 16 mm - 3 m	3 700393 926167		
Sku. 121110004	Blue Diameter 16 mm - 3,5 m	3 700393 926174		



SISAL HALTERS



Natural, ecological and biodegradable, the sisal is very resistant. Sold by 12.

Sku. 121110006	Diameter 16 mm - 3,5 m	3 700393 926259		
-----------------------	------------------------	-----------------	--	--



PP/SISAL HALTERS



Sold by 12.

Sku. 121111V	Length: 4 m. Diameter: 14 mm	3 338020 042302		
Sku. 121110005	Orange white Length: 3,5 m. Diameter: 16 mm	3 700393 926181		

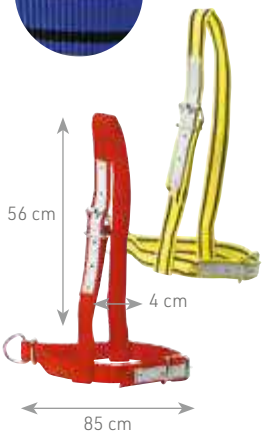

NYLON HALTER FOR COWS KAMER

Very resistant. Two reinforced adjustment loops (headpiece and noseband). Made in Europe.

Sku. 121107	Yellow and black	3 338020 058549		
Sku. 121107003	Red	3 338020 058570		
Sku. 121107006	Blue	3 338020 058587		



COW PRESENTATION HALTER KAMER

Very robust nylon. Reinforced leather strap. Chinstrap chain and fastening ring. Supplied without lead. Height: 47,5 cm, circumference: 64 cm, width: 4 cm. Made in Europe.

Sku. 121103	Yellow/black	3 338020 055029		
--------------------	--------------	-----------------	--	--

HIGH QUALITY KAMER NYLON COLLAR FOR COWS

Very robust double thickness nylon collars. Attachment ring. 125 cm x 4 cm. Thickness: 5 mm. Made in Europe.

Sku. 121161002  3 338020 076123

Black 

Sku. 121161003  3 338020 076130

Red 

Sku. 121161006  3 338020 076147

Blue 



HIGH QUALITY KAMER NYLON COLLAR FOR BULLS

Very sturdy nylon collars due to their width and double closure. Leather reinforcement of the loop. Attachment ring. **New color: yellow and black.** Made in Europe.

Sku. 121126010  3 700393 918810

Length 1,70 m - 
Width 7 cm

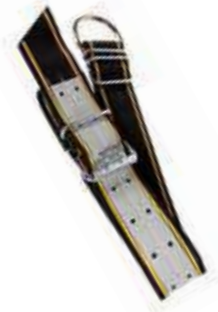

SUPERIOR KAMER QUALITY NYLON COLLAR FOR COW

The top of the range. Necklace 1,30 m. Leather reinforcement at the adjustment loop. Nice finish. Width 4 cm. Made in Europe.

Sku. 121128006C  3 700393 920394

Blue 



NYLON CALF COLLAR KAMER

Leather reinforced adjustment strap. Supplied with attachment clip. **80 cm long. Width: 4 cm.** Available in different colours. Practical to distinguish groups. Made in Europe.

Sku. 121122  3 338020 010707

Yellow and black 

Sku. 121122003  3 338020 044313

Red 

Sku. 121122006  3 338020 044320

Dark blue 

Sku. 121122008  3 338020 044337

Green 



HALTER FOR CALF KAMER

This calf halter is made of high quality nylon. Leather finish. Tightening loop. Made in Europe.



Sku. 121139  3 700393 915444

Blue 







ADDITIONAL HOOF SCRAPER KAMER

Sk. 106625  3 338020 002696
Black painted steel
30 cm 





ONE HAND HOOF CUTTER KAMER

Sk. 106601  3 338020 043231
One hand hoof cutter 





HOOF CUTTER ARTICULATED KAMER

High transmission ratio. Powerful jaws with removable blades. For horizontal attack to the callus. Antislip handle. Total length: 41 cm (16").
Sk. 106602  3 338020 002429
41 cm 





PROFESSIONAL HOOF CUTTER KAMER

Round head with crossed jaws. Allows a side cut of the callus.
Sk. 106604  3 338020 043040
Nickel-plated steel 







HOOF RASP STRAIGHT WITH HANDLE KAMER

Double sided (fine and coarse). Plastic handle. Length: about 35 cm (13 3/4").
Sk. 106621  4 019003 004287
35 cm with handle 











SPECIAL HOOF DISC UKAL

Especially for trimming the hooves of cattle. Fits on all current types of electric hoof trimmers. Boring 22 mm. **Supplied in sets of 5.**
Sk. 106681120  3 700393 929373
Ø 115 mm 
Sk. 106681220  3 700393 929366
Ø 125 mm 







HOOF DISC

The granulometry avoids dirtying the disc and heating of the foot. Boring 22 mm.
Sk. 106690115  3 338020 048007
Medium grain
Ø 115 mm 
Sk. 106690125  3 338020 048014
Medium grain
Ø 125 mm 
Sk. 106691115  3 338020 048038
Large grain Ø 115 mm 
Sk. 106691125  3 338020 048045
Large grain Ø 125 mm 





DL DISC Demotec

Lightness and robustness combining cutting efficiency and incomparable life time! No heating of the foot, no dust nor smoke. One blade set treats over 400 cattles. Tungsten blade.
Sk. 106695001  3 700393 900143
DL Disc - Ø 115 mm 
Sk. 106695002  3 700393 900518
Blade and screw set 

DL SOFT DISC Demotec

Less aggressive cutting due to the positioning of the blades. Blades can be used on both sides.

Sku. 106695101  3 700393 920547

DL soft disc Ø 115 mm   48

Sku. 106695102  3 700393 921247

Replacement blade x 1 

Sku. 106695102SET  3 700393 921254

Replacement blade x 7 



BLACK BLUE HOOF KNIFE



Black Blue hoof knives are of high quality. The blade is tempered to allow easy sharpening and also to allowing the blade to stay sharp. Available in several models. The Black Blue knives are very strong. Ergonomic shape. Treated steel blade.

Sku. 106609BB1  3 338020 043613

Wide blade right   108

Sku. 106609BB2  3 338020 043620

Wide blade left   108

Sku. 106609BB3  3 338020 043637

Wide blade double 

Sku. 106609BB4  3 338020 054947

Thin blade right 

Sku. 106609BB5  3 338020 055159

Thin blade left   54



BLACK BLUE RING HOOF KNIFE



BLACK BLUE ring hoof knife. Steel blade. Wooden handle. Very nice finish.

Sku. 106613BB  3 338020 052103

Ring hoof knife   172



PROFESSIONAL HOOF KNIFE TOP RANGE

The professional hoof knife! Handle made of exotic wood (bubinga). High cutting quality due to its very sharp blades. The blade is 65 mm long.

Sku. 106609001  3 338020 061006

Wide right blade 

Sku. 106609002  3 338020 061013

Wide left blade 

Sku. 106609003  3 338020 061020

Wide double blade 



LE PAREUR HOOF KNIFE



Steel blade. Ergonomic wooden handle for a better grip. Very nice finish. Economical hoof knife.



Sku. 106612001  3 338020 002535

Wide blade right   32

Sku. 106612002  3 338020 002542

Wide blade left   108

Sku. 106612003  3 338020 002559

Wide blade double   40





RING HOOF KNIFE



Steel blade. Wooden handle. Good price quality ratio.

Sku. 106613  3 338020 002566

Standard ring hoof knife   72





SHARPENING STONE KAMER

Essential to sharpen hoof knives, hoof shears and other knives used by shepherds. The very fine grit of the stone allows for precise sharpening of cutting tools for optimal use. 13 cm long.

Sku. 106616 

Sharpening stone



HOOF CHECKER Demotec

Shows the ideal shape of the hoof in a fast and safe way. It also allows to check the hoof angle between the base and the upper front part of the hoof. The angle should be between 45° and 50°. The angle of the tester is 50°.

Sku. 106643020 

Hoof checker



DEMOTEC EASY BLOC Demotec

Easy, quick, safe and economical. Lameness of cows can lead to significant economical losses due to a reduction of the production and weight loss in the short term. The Easy Bloc makes it possible to treat the lameness in an easy and economical way even for unexperienced users. It can be used on all kinds of hooves.

Packaging: box of 4 or 12 treatments.

Sku. 106643004 

Box of 4 treatments 

Sku. 106643010 

Box of 12 treatments 

Sku. 106643011 

250 ml liquid 

Sku. 106643012 

Powder 500 g 



BLOCKS FOR DEMOTEC EASYBLOC Demotec

Sku. 106643013 D/2 

Right x 2 

Sku. 106643013 G/2 

Left x 2 

Sku. 106643013 DG2 

2 right, 2 left 



DEMOTEC 90 Demotec

The DEMOTEC 90 mixture produces a very fluid (liquid) paste. After 2 to 3 minutes this mixture gets thicker and more pasty. Now it can be spread on the put it on the healthy hoof and on the wooden block. 7 to 8 minutes later the DEMOTEC 90 is completely hardened.

Sku. 106645002 

2 treatments

Sku. 106645011 

Liquid 500 ml

Sku. 106645012 

Powder 1 kg 



DEMOTEC 95 Demotec

The DEMOTEC 95 mixture gives you immediately an adhesive paste ready to spread on the healthy hoof and the wooden block. **6 to 7 minutes later the mixture is completely hardened.** Box of 14 treatments.

Sku. 106644010 

14 treatments

HOOF CARE ADHESIVE



Fast 2-components glue for hoof care. The green colour indicates a good mix of the two components. Works between 10 and 20 seconds. The cow can be released after a maximum of 4 minutes. Works from -10° to +30°. To be stored between 0 and 25 degrees. No GHS08 warning.

Sku. 106653001



200 ml in a bag



HOOF CARE ADHESIVE



Fast 2-components glue for hoof care. The green colour indicates a good mix of the two components. Works between 10 and 20 seconds. The cow can be released after a maximum of 4 minutes. Works from -10° to +30°. To be stored between 0 and 25 degrees. No GHS08 warning.

Sku. 106653002



200 ml in bulk



HOOF CARE ADHESIVE- SINGLE USE



Fast 2-components glue for hoof care. The green colour indicates a good mix of the two components. Works between 10 and 20 seconds. The cow can be released after a maximum of 4 minutes. Works from -10° to +30°. To be stored between 0 and 25 degrees. No GHS08 warning. Delivered with a cannula for 1 application.

Sku. 106653003



25 ml syringe in a bag



CANNULAS FOR HOOF CARE ADHESIVE



These cannulas are essential for a right application of the glue.

Sku. 106653100



Bag of 10



CANNULAS FOR HOOF CARE ADHESIVE



These cannulas are essential for a right application of the glue.

Sku. 106653101



Box of 100



GUN FOR HOOF CARE ADHESIVE



For the application of BLOCK BOND 200 ml, we strongly recommend the use of this gun. Compatible with the following glues: sku.106653001 and 106653002. This gun has been tested and approved by BLOCK BOND. Assorted colors.

Sku. 106653200



By piece



WOODEN BLOCKS



For the range DEMOTEC 90, DEMOTEC 95 and SEPTICARE BOND EXPRESS.

Sku. 106645013002



By piece



Sku. 106645013020



By 20

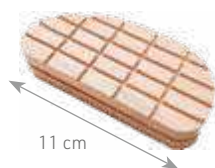

11 cm

WOODEN BLOCKS XL



For the range DEMOTEC 90, DEMOTEC 95 and SEPTICARE BOND EXPRESS.

Sku. 106645014



XL 13 cm. By piece



13 cm



FIND OUR VIDEO ON YOUTUBE



LEG SPLINT FOR CALVES



Specifically designed for calves suffering from flexion of the pasture joints. The joint attachment allows the calf to be held and the calf to stand upright on the front legs and move freely. Leave in place for 2 to 4 weeks minimum. Durable washable nylon and durable molded ABS material. Internal padding. Velcro® safety fasteners. Treatment without plaster and bandages. Fully adjustable and reusable. Length: 22 cm.

Sku. 101125 By piece 3 700393 915789 22



ADHESIVE HOOF TAPE



Adhesive and very resistant tape. Ideal for bandaging hooves of cattle and horses.

Sku. 106646 3 338020 002795 32

25 m x 5 cm

Sku. 106646050 3 700393 940439 30

50 m x 5 cm



TAR BANDAGE "CERTOPLAST"



To bandage and apply protection bandages on large animals. Adhesive on both sides. Aluminium packaging. Black.

Sku. 106646100 4 022742 000632 60

25 m x 4,5 cm



COHESIVE FLEXIBLE BANDAGE FOR COMPRESSION



Quick and easy application. Beginning easy to find. Strong fabric, can be torn by hand. Size stretched: 10 cm x 4 m. Size unstretched: 10 cm x 2,5 m. Contains latex.

Sku. 106700 3 700393 962899 12

Assorted fluorescent colors - By 18

Sku. 106710 3 700393 962905 12

Assorted classic colors - By 18

Sku. 106710102 3 700393 922282 12

Black - By 18

Sku. 106710103 3 700393 922237 12

Red - By 18

Sku. 106710106 3 700393 922220 12

Blue - By 18

PREMIUM HOOFMAT

The "Premium Hoofmat" uses a 31 mm foam encased in a premium quality blue outer fabric. To optimise treatment, place the mat at the entrance to the milking platform. After milking, hang the hoofmat over a rail and hose it down. The "Premium Hoofmat" lasts over 100 000 cow passes. Contains up to 35 liters of hoofbath remedy. Top up the mat after 80 cow passes. Size: 180 x 90 cm.



Sku. 113001 9 417027 231743 5

180 x 90 cm





SEPTICARE CATTLE HOOF MAT

Disinfecting foam for building entrances. Perfect for the passage of animals. Large and top class model. The whole hoof treated due to the thickness of the mat. Capacity: 120-160 liters.

Sku. 113100001	180 x 90 x 10 cm		3 338020 062997
-----------------------	------------------	---	-----------------



NORWEGIAN PINE HOOF TAR



Hoof tar is made of natural wood tar. This natural tar protects and nourishes the hoof. Available also for hunting.

Sku. 000020	1 kg <i>Limited stock</i>		3 338020 000029 
Sku. 000025	5 kg <i>Limited stock</i>		3 338020 000036



BEECH HOOF TAR



Beech Tar. Protects hooves and nourishes the hoof horn. Available also for hunting. **Very good price-quality ratio.**

Sku. 000030	1 kg		3 700393 927102 
Sku. 000035	5 kg		3 700393 927119



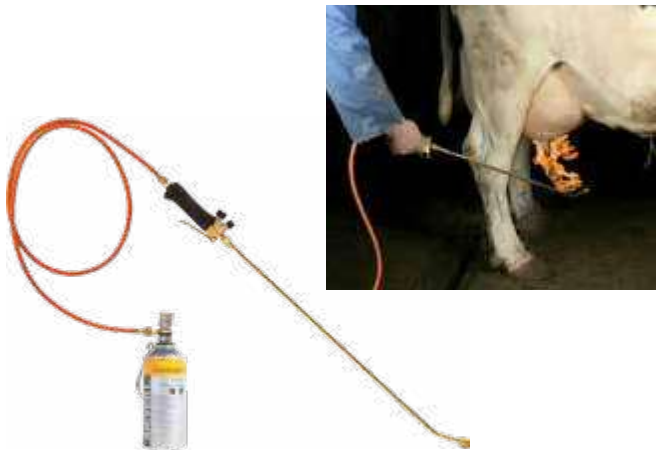

— THERMIC DEPILATOR

Depilates udder hair in a secure way and without causing pain by a cold flame. It does not pose a danger to people nor animals. Appreciated for its fast action. Depilate approximately 40 to 50 animals. Supplied with: a 750ml propane gas cartridge (99 %) Sku. 103400001, a 2 bar regulator, a flexible tube (20 bar) of 2 meters, a 80 cm spray nozzle, an ergonomic handle with 2 plugs and a belt clip.

Sku. 103400	Thermic depilator		
Sku. 103400001	Propane gas refill for thermic depilator. Cartridge 750 ml of propane (99 %)		



— DOUBLE TISSUES



For udder cleaning. Very resistant to water washout. Do not shrink.

Sku. 112131	
Dimensions: 2 x 35 x 32 cm. By 10	



— SEPTICARE UDDER TOWELS



Non-woven tissues made of 80 % viscose and 20 % polypropylene. Conform to food standards. Do not contain formaldehyde. Used to wash the cow udders. Much softer than woven tissues. They ensure an excellent cleaning and a better wiping of the teat due to the non-woven composition. Equal weight, absorb twice as much water than woven tissues. Machine washable, also in very hot water. Weight: 240 g/m².

Sku. 112131001	
Dimensions: 34 x 37 cm. Bag of 25	



— FOAM DIP CUP



Produces a dense foam. Increases the contact surface and efficiency of foaming products.

Sku. 112130006	
-----------------------	--



— TEAT DIP CUP



For soaking the teat prior to milking.

Sku. 112130	
--------------------	--



MANUAL TEAT SPRAYER

Manual sprayer with rotary nozzle directional jet, facilitates spraying.

Sku. 112126



680 ml



CONICAL PLASTIC MILKING CUP

Conical strainer with tab to remove the strainer easily.

Sku. 124070047



1 L



TRANSPARENT DOSING CUP

Food safe plastic.

Sku. 124064



1 L



MASTITIS DETECTION KIT



For mastitis detection of reactive liquid. The kit contains: 1 paddle, 1 dosing bottle, 1 liter of reactive liquid, 1 teat wipe, 5 Velcro ankle straps, test report leaflet.

Sku. 112137



Complete kit



REACTIVE LIQUID

For the test to detect mastitis. This test gives information about the situation of the quarters before any changes in appearance are visible (inflammation of mammary tissue, lumps, water and blood, etc.). To be used with the test paddle. Consists of anionic surface-active agent and bromocresol purple.

Sku. 112134



Reactive liquid



Sku. 112136



Dosing bottle 1 ml

Limited stock

Sku. 112132



Test paddle



PLASTIC CATHETER



Supplied by 10.

Sku. 112204



By 10

Sku. 112204250



By 250



NEW

CATHETER

Ogival catheter. Used for intra-mammary injections in the lactiferous sinus (antibiotic depletion). Used with a metal or plexi DERMAPLAST syringe. Luer lock end. By 5. Diameter: 2,5 mm.

Sku. 112210001/5



38 mm

Limited stock

Sku. 112206/5

Limited stock



100 mm

Sku. 112206/12



10 cm par 12

Sku. 112205/12



8 cm par 12



MASTITIS INDICATOR TEST PAPER

The use of reactive paper helps to detect rapidly milk acidification caused by increased number of cells. The mastitis touches rarely the whole teat. That's why it is important to control and compare the 4 quarters. Delivered in bag of 25 pieces.

Sku. 112219



By 25

Limited stock



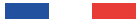

ORGANIC MILKING GREASE

The first ORGANIC milking grease! **Ideal for organic farming.** This new organic milking grease, MADE IN FRANCE, is formulated with beeswax and sunflower oil. It facilitates milking thanks to its lubricant properties. It protects and helps to heal udders by creating a protective layer. No preservatives, no disinfectants, no perfumes, no dyes. White color.

Sku. 112503	500 ml	4 012113 051547	6
-------------	--------	-----------------	---



EUTRA MILKING GREASE

Milking grease is for protecting and caring for teats and udders. Made from high-quality refined mineral oils, it facilitates milking due to its lubricating properties. Helps to protect and care for the udders by creating a protective layer and helps the healing of small wounds. **Swiss original formula.** No preservatives, no disinfectant, no fragrance substances, no colorings. Composition: Paraffinum liquidum, Petrolatum. Color: white. **Can not be used on organic farms.**

Sku. 112500002	250 ml	4 012113 015501	6
Sku. 112500005	500 ml	4 012113 016904	6
Sku. 112500010	1 L	4 012113 014900	6
Sku. 112500030	3 L	4 012113 014306	4
Sku. 112500050	5 L	4 012113 015709	2



EUTRA GEL

Gel made of Menthol and tea tree extract to protect and take care of the teats. **Cooling effect.** Effective cleaning thanks to the antiseptic properties of the plants extracts. **Can not be used on organic farms.**

Sku. 112520005	500 ml	4 012113 003362	6
----------------	--------	-----------------	---

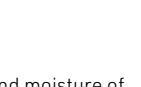

CREMAPIS MILKING GREASE

High-quality milking fat. **Necessary for a good softening** and moisture of the teat tissue. Aseptic. Color: yellow.

Sku. 112160030	3 L	3 338020 029471	4
----------------	-----	-----------------	---



TRAYBAIN MILKING GREASE

Facilitates milking and maintains healthy and soft teats. **Protects from cold and draughts.** Color: green.

Sku. 112170001	1 L Limited stock	3 275970 006490	12
Sku. 112170005	5 L Limited stock	3 275970 006513	2



TEAT PLUG FOR MILKING LINERS

Closes a milking liner when a teat is not working or if a teat does not exist.

Sku. 112390002	By 2		
-----------------------	------	---	---

NON-WOVEN DISK FILTERS BOSCH AND SCHÖRLE



New generation non-woven milk filters welded through a process without glue or chemicals. **Öko -Tex Standard 100 and can be used on organic farms.** They don't affect the quality of milk and allow a smooth and rapid flow. Very resistant, they are not weakened by the holes formed by the stitching unlike sewn filters. Box of 200.

























Sku. 124075170	170 mm		
Sku. 124075180	180 mm		
Sku. 124075200	200 mm		
Sku. 124075230	230 mm		



NON-WOVEN FILTERS BOSCH AND SCHÖRLE



New generation non-woven milk filters welded through a process without glue or chemicals. **Öko -Tex Standard 100 and can be used on organic farms.** They don't affect the quality of milk and allow a smooth and rapid flow. Very resistant, they are not weakened by the holes formed by the stitching unlike sewn filters. **No thread = no hole = better filtration.** Box of 250.

Sku. 124064250	250 x 125 mm		
Sku. 124064570	570 x 44 mm		
Sku. 124065250	250 x 58 mm		
Sku. 124065320	320 x 58 mm		
Sku. 124065465	465 x 58 mm		
Sku. 124065500	500 x 58 mm		
Sku. 124065530	530 x 58 mm		
Sku. 124065620	620 x 58 mm		
Sku. 124068455	455 x 80 mm		
Sku. 124068600	600 x 80 mm		
Sku. 124068620	620 x 80 mm		
Sku. 124068640	640 x 80 mm		
Sku. 124068800	800 x 80 mm		
Sku. 124069610	610 x 95 mm		



FIND OUR VIDEO ON YOUTUBE



DID YOU KNOW?

Milk filters are used for safety and health reasons. They are put on the milking machines to filter milk from dirt and bacteria. The filter size must be chosen according to the milking machine.



— OIL FOR MILKING MACHINE UKAL

The special oil for milking machine is designed for the lubrication of vacuum milking machine pumps. Used in summer and winter. Suitable for all types of vacuum pumps. **Viscosity: to 40° C: 46 cst, to 100° C:7,6 cst.**

Sku. 112600005



5 L



— CONTROL COVER WASHER

For control cover (Sku. 112601).

Sku. 112601001



— CONTROL COVER WITHOUT SEAL

Without seal.

Sku. 112601



Control cover without seal
Limited stock



— QUARTER MILKER

For the milking of a teat which is sick or under treatment. Avoids mixing with healthy milk.

Sku. 112129



8 L
Limited stock



Milk cans

STAINLESS STEEL MILKING PAIL

Robust and very durable. Very easy to clean. Without lid. Food grade quality.

Sku. 124008030



Height: 49 cm.
Ø base 33,5 cm.
Ø opening 18 cm



STAINLESS STEEL MILK CAN FOR TRANSPORT

Really robust, made in stainless steel. Food grade quality.

Sku. 124009030



30 L. H 50 cm.
Ø 33,5 cm



MILK CAN WITH ALUMINIUM LID

Made of aluminum, robust and very resistant to impacts. Does not pick up odors and easy to clean. Food grade quality.

Sku. 124100010



With handle 10 L.
H 32 cm. Ø 25 cm

Sku. 124100020



Without handle 10 L.
H 32 cm. Ø 25 cm



ALUMINIUM MILK SAMPLER DIPPER

Can measure and collect the milk.

Sku. 124063010



1 L



MILK FUNNEL & ALUMINIUM GRILLS

Sold with cones set, lower disc, strainer and circlips. Food grade quality. Fits on milking pots for optimal filtration.

Sku. 124020030



Ø 300 mm



ALUMINIUM BUCKETS

Aluminum bucket with spout. Capacity: 12 L.

Sku. 120003012



12 L



Curry Comb



SPECIAL DAIRY BRUSH

Can be boiled. Food grade nylon bristles. Very robust. Bristles length: 40 mm. Weight: 270 g.

Sku. 124001



L 195 x W 60 x H 60 mm

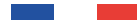

SCRUBBING BRUSH

Can be boiled, robust. Food grade nylon bristles. Weight: 260 g.

Sku. 124002



L 195 x W 60 x H 60 mm



MILK TANK BRUSH

Food grade nylon bristles. Can be boiled. To use with a handle. Supplied without handle. Very robust. Bristles length: 40 mm. Weight: 280 g.

Sku. 124003



L 90 x W 55 x H 115 mm



CLEANING BRUSH

Food grade. Supplied without handle. Width: 26 cm.

Sku. 124004



26 cm



BRUSH WITH SHORT HANDLE

Bristles length: 40 mm. Weight: 220 g. Food grade.

Sku. 124006



L 260 x W 172 x H 55 mm

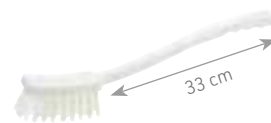

BRUSH WITH LONG HANDLE

Bristles length: 40 mm. Weight: 220 g. Food grade.

Sku. 124007



L 400 x W 45 x H 55 mm



HANDLE FOR BRUSH

Polypropylene handle.

Sku. 124000P



Length: 1,20 m



SHORT STRAIGHT BRUSH

Straight brush used to clean milking tubes. Food grade nylon bristles.

Sku. 124010001



L 40 cm - Ø 10 mm



ROTARY BRUSH

Rotary brush used to clean milking liners. Can be used with all brands. Food grade nylon bristles.

Sku. 124010



Food grade nylon bristles



LONG STRAIGHT BRUSH

Straight brush used to clean milking tubes. Food grade nylon bristles.

Sku. 124010002



L 100 cm - Ø 15 mm



METAL CATTLE CURRY COMB

KAMER

Nickel-plated comb with metal handle. Flat body with coarse teeth, mane and tail comb.

Sku. 123302



Nickel-plated comb with handle
21 x 17,5 cm



SQUARE CURRY COMB WITH COMB

KAMER

Coarse teeth, flat body, equipped with a mane and tail comb, nickel-plated metal. Plastic handle.

Sku. 123303



22 x 24 cm



SQUARE CURRY COMB FLAT BODY

KAMER

Coarse teeth, flat body, made of nickel-plated metal. Plastic handle. 7 rows.

Sku. 123305



14,5 x 22,5 cm



CURRY COMB

Round metallic curry comb (also called "american") serrated differently on each side for more or less sensitive horses. Stays dirt free.

Sku. 130E700029



14 x 27 cm



CATTLE | Brushes



NATURAL FIBER BRUSH KAMER

Sku. 123307



220 X 55 X 700 mm -
Big model
Limited stock



WOODEN CARDER KAMER

Size: 120 x 170 mm.

Sku. 151010



120 x 170 mm -
Large claw



PNEUMATIC CARDER KAMER

Size: 120 x 170 mm.

Sku. 151030

120 x 170 mm -
Fine claw



COW BRUSH KAMER

Zinc coated metal. Very strong spring. Supplied with 2 brushes with plastic back and nylon bristles. **The cow brushes are essential elements of hygiene and comfort in a cattle's life in a shed.** Avoids injuries caused by rubbing against concrete and metal parts of the shed. Spring Sku.: 9123327.

Sku. 123315

Cow brush in zinc
coated metal



SPARE BRUSH KAMER

For shed brushes Sku. 123315 and 123325. Plastic back. Nylon bristles.
Size: 50 x 10 x 10 cm.

Sku. 123316

Spare brush for
shed brushes



COW BRUSH Vink

Special nylon brush for livestock. Horizontal moveable brush. Solid spring suspension. Spring Sku.: 9123325.

Sku. 123325





















VINK nylon cow
brush



ROUND BRASS BELL

KAMER

Clapper available on request. Please consult the list in the price list and on the website.



Sku. 121803100	Ø 100 mm. Loop: 50 mm. Height: 70 mm			
Sku. 121803110	Ø 110 mm. Loop: 50 mm. Height: 77 mm			
Sku. 121803120	Ø 120 mm. Loop: 70 mm. Height: 84 mm			
Sku. 121803130	Ø 130 mm. Loop: 70 mm. Height: 91 mm			
Sku. 121803140	Ø 140 mm. Loop: 70 mm. Height: 98 mm			
Sku. 121803150	Ø 150 mm. Loop: 70 mm. Height: 105 mm			
Sku. 121803180	Ø 180 mm. Loop: 82 mm. Height: 126 mm			



BLACK BLUE STEEL BELL



Steel bell for sheep and goats. Nice tone. Clapper available on request. (Sku. 1218069064 and 1218069088). Please consult the list in the price list and on the website.

Sku. 121806064	Ø 64 mm. Loop: 50 mm. Height: 64 mm			
Sku. 121806088	Ø 88 mm. Loop: 50 mm. Height: 115 mm			
Sku. 121806104	Ø 104 mm. Loop: 75 mm. Height: 104 mm			
Sku. 121806120	Ø 120 mm. Loop: 82 mm. Height: 120 mm			
Sku. 121806144	Ø 114 mm. Loop: 82 mm. Height: 144 mm			



BROWN LEATHER COLLARS

KAMER

Soft chrome-tanned leather. Ideal for bells. Different sizes available: 6 or 8 cm wide. Length: 120 or 135 cm.

Sku. 121162126	120 x 6 cm			
Sku. 121162128	120 x 8 cm			
Sku. 121162136	135 x 6 cm			
Sku. 121162138	135 x 8 cm			



PUNCH PLIERS

To adjust your leather goods.

Sku. 130E700423	By piece		
------------------------	----------	---	---



Heiniger

XPLORE THE POWER

XPLORERPRO
≡2-SPEED≡



PATENTED

SWISS MADE  PRECISION



TENSION
INDICATOR



2-speed



Li-Ion



-120 min



ERGONOMIC



light



UKAL

— SHEEPS

52	Lambing
53	Feeding
55	Clipping
56	Dehorning
56	Castration
57	Restraining
59	Hoof care
60	Bells



EWESPOON WITH TIES

KAMER

The ewespoon is a simple and economical way to control gestation problems. It is used for ewes and goats to keep the uterus in place in case of a prolapse. His model is made of plastic with two ties and is heat resistant.

Sku. 101112

By 4



USE OF THE EWESPOON

There are several reasons of uterus prolapse by ewe:

- mineral deficiency,
- traumatic (caught up in a rush during feed distribution),
- obstetrical (early contractions).

For ewes, the uterus prolapse is before the lambing. The ewespoon, must be placed after cleaning and placing the genital tract in its original place.

Use always disposable gloves, and obstetrical gel. To keep the ewespoon in place, attach it to the wool, or attach a tie of the ewespoon to the ewe straps. The ewespoon must be released while lambing. Pay careful attention to ewes with a ewespoon to avoid any problems with lambing and delivery.



SHEEP EWESPOON IN NYLON

KAMER

Helps to keep the uterus in place in case of an prolapse. Heat-proof plastic.

Sku. 101110002



By unit



PROLAPSE NEEDLES

KAMER

Length: 8 cm used in supporting the uterus after prolapse. Nickel pins. Supplied by 5.

Sku. 101114



Without eyelet.
Size: 8 cm



Sku. 101114A



With eyelet.
Size: 8 cm



DID YOU KNOW?

Latex is made from the sap of rubber trees and offers an easier sucking thanks to its softness and flexibility.



LAMB FEEDER 11 L

Multi-bottle twin compartment placed on rack or board. Comes complete with teats and the corresponding valves. With the new flared shape of each of the two compartments, the flow of milk is total. No more waste or loss of milk. In addition, it is very robust due to the reinforcement of the central part. High Density Polyethylene (HDPE) grade. The original! Comes with 6 natural rubber lamb teats Sku. 120004 and 6 valves Sku. 120022.



Sku. 120008006





11 L



COMPLETE SET FOR LAMB FEEDER

It consists of 6 natural rubber teats for lamb Sku. 120004 and 6 valves. For multi-bottle feeder Sku. 120008006.



Sku. 120008007  3 338020 010493  84

Complete set for lamb feeder



VALVE FOR LAMB TEATS

For lamb teat Sku. 120004.



Sku. 120022  3 338020 010561  130

In aluminium. By 6



LATEX LAMB TEAT

With hole.

Sku. 120004006  3 700393 960901  84

By 6

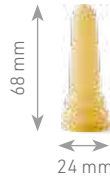

LATEX TEAT FOR BOTTLE

Pierced. Really supple.

Sku. 120019042  3 700393 960796  84

By 6

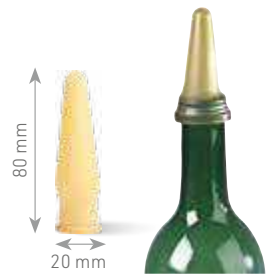

COMPLETE LAMB FEEDER, 6 RUBBER TEATS



Nursing trough for lambs without handle. Ideal for 6 lambs. Plastic with steel hook. Supplied with 6 natural rubber teats and aluminum valve. Dimensions: 38,1 x 30,5 x 25,4 cm. Capacity: 12 liters.

Sku. 120008002 12 L  3 700393 966064 



NATURAL RUBBER LAMB TEAT FOR LAMB FEEDER

Very flexible natural rubber teats. X shaped hole. For lamb feeder bucket Sku. 120008006.

Sku. 120004050  3 700393 923586  20

By 50

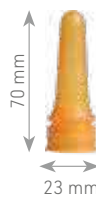

NATURAL RUBBER LAMB TEAT FOR BOTTLE

Pierced. Supple.

Sku. 120019  3 338020 010547  84



By 6





LAMB FEEDER BOTTLE



38 mm extra wide neck for easy filling, with a strong plastic collar to ensure secure fixing of the teat. Extra tough to prolong life and calibrated for accurate feeding, sterilize by boiling. Delivered with one teat.

Sku. 120008120  3 700393 924521
500 ml 



COLOSTRUM FEEDER FOR LAMB



Suitable for feeding the correct amount of colostrum to large lambs without refilling; positive pressure can be applied to save time. Length: 33 cm.

Sku. 120008130  3 700393 924507
250 ml 



TEAT FOR LAMB BOTTLE



Specially designed teat with unique moulded in vacuum release valve. Bulbous teat end encourages more rapid acceptance by lambs. Hollow cone tip allows flow of milk to be regulated.

Sku. 120008220  3 700393 924750
By 6 



TRUSTI FEEDER FOR LAMB

A specially designed Trusti Tuber ANTAHI rehydrator for lambs with a specific mouthpiece and a flexible and transparent tube. Simple to use with one hand, very practical and easy to hold. Ergonomic and stable shape allowing a good flow by gravity and not under pressure, safer and easy to control. Capacity: 240 ml.

Sku. 120008200  9 421904 214224
240 ml 





COLOSTRUM BAGS FOR LAMBS 1 L



Colostrum bags help to develop and strengthen lambs' immunity from birth. They come with a large opening to facilitate filling and cleaning and can hold **1 litre** to meet the feeding needs of young lambs and kids. The bags can be deep-frozen flat to preserve the nutritional qualities of colostrum over time. They are suitable for pasteurisation and can be quickly defrosted. Their comfortable handles make them very user-friendly for the farmer. The bag's transparency is also a plus point. It allows the user to see at a glance how much is left in the bag. Colostrum bags are **designed to be reused** (durability and easy cleaning). Please note that the number of times a bag can be reused will depend on how well it has been cared for.

Sku. 120008210 By 10  9 421904 214644  

Sku. 120008250 By 50  9 421904 214651

Sku. 120008300 Teats for colostrum bags By 6  3 700393 923883  



HAND SHEEP CLIPPERS

KAMER

Sku. 100337



1-hand sheep clippers



Sku. 100337101



Comb blade set
Limited stock



NICKEL-PLATED SHEEP SHEARS



Very nice finish in nickel-plated steel. This nickle plated straight blade sheep shears is great for small sheep. Easy clipping. Single bow. High quality cutting.

Sku. 100339002



Size: 29 cm
Blade's length: 14,5 cm



DOUBLE BOW SHEEP SHEARS

KAMER

Double bow, red painted handle sheep shears comes with straight blades. The handle and blades are one piece of forged steel. Used for parts which are difficult to reach or for shearing the whole sheep. Available in two sizes.

Sku. 100339



Size: 34 cm.
Blade's length: 16,5 cm



Sku. 100339001



Size: 29 cm.
Blade's length: 14,5 cm

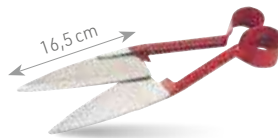

BLACK BLUE SHEEP SHEARS RIGHT-HANDED



The black blue sheep shears are incontestably the finest shears in our range. Made from hardened and tempered steel, they are equipped with rubber stoppers to smoothen the shearing. Strong and long lasting.

Sku. 100350



Size: 29 cm
Blade's length: 16 cm



PROFESSIONAL YELLOW SHEEP SHEARS

KAMER

Professional yellow sheep shears. One piece handle and blades / double bow **for intensive use**. Its manufacturing quality and 16,5 cm blades allow you to shear your sheep easily.

Sku. 100360



Size: 34 cm
Blade's length: 16,5 cm

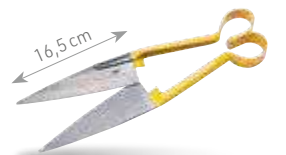

SHEEPS | Dehorning and castration

Dehorning



COSMOS ELECTRIC DEHORNER FOR GOATS

The Cosmos electric dehorner with its Ø 14 mm tip specifically designed for goats, is mains-operated for extreme ease-of-use. Always ready for use, it heats up and cools down almost instantly. With its unique patented system, it stops automatically when the 10-second dehorning cycle is complete. This guarantees quality dehorning for breeders, who know as soon as the operation is finished. You no longer need to worry about the power supply as its 6-metre mains cable offers superb handling for high-quality dehorning. With numerous technological innovations, such as the ceramic head with integrated circular heating wire and a built-in power supply indicator, it helps operators save time. Weight: 560 g. Heating temperature: 700 °C.

Sku. 103017300	On mains		
-----------------------	----------	---	---

THE 4 R'S OF DEHORNING

The Right moment

As soon as possible and before 4 weeks: the younger they are, the more they are easy to handle. At this age the veins come just under the skin.

The Right restraints

A lamb that does not move restraining dehorning easier for the farmer. This represents 80% of a successful dehorning.

The Right technic

Shear prior to properly locate the horn. Cauterize in 10 seconds without pressing too hard (10 seconds max). Make a furrow of 4-5 mm. Cauterization, not a burn.

The Right pain management after dehorning

Apply a cleaning spray that cools cauterization. Treat against flies. Keep under careful observation the following 48 hours. Avoid putting animals outside in wet weather.



Castration



BLOODLESS CASTRATOR

KAMER

Articulated with closing stop. Made of high quality nickel-plated. The castration can be performed as soon as the testicles have reached their final firmness (not their final size). The bloodless castrator allows the testicular cord to be crushed through the scrotum skin. You must proceed by crushing one testicular cord at a time, and make two crushes at 1-2 cm (1/2" - 3/4") apart.



- Locate the testicular cord.
- Block it with the castrator for 5 minutes.
- Repeat the same operation 1-2 cm (1/2" to 3/4") lower on the same cord. The noncrushed space maintains irrigation and prevents gangrene.
- Repeat on second testicular cord.
- Never try to crush simultaneously both testicular cords. It may be ineffective and it will damage the castrators. After using and cleaning the castrator must be stored opened.

Sku. 102223023	23 cm		
Sku. 102223030	30 cm		
Sku. 9102223048CLE	Tightening key		

METAL KNEE PAD KAMER

Suitable for all bloodless castrators.



Sku. 102224		
By unit		

RUBBER RING APPLICATOR

KAMER



With a wide opening for an easy application and with a high gear ratio. Made of nickelplated forged steel. Very resistant. High-quality model! Can also be used for tailing.

Sku. 102201  3 338020 001262

Nickel-plated forged steel 



STANDARD RUBBER RINGS APPLICATOR

Economical model.

Sku. 102200  3 338020 058372

Steel 



CLASSIC ORANGE RUBBER RINGS

KAMER

Rubber used for tail docking and castration. Premium quality, rolled rubber. Please check the safety instructions before use. Keep away from children. Professional use only.

Sku. 102202100  3 338020 001279

By 100 

Sku. 102202500  3 338020 001286

By 500



ELASTRATOR RUBBER RINGS



Quality rubber rings. For castration and tailing of lambs, goats and calves. The younger the animal the better. Elastrator rings are designed to be used on calves no older than two weeks, and lambs and goats no older than three weeks. Use after this period is not recommended.

Sku. 102150100  9 321509 130373

Box of 100 

Sku. 102150500  9 321509 130380

Box of 500



SHEPHERD LEG CROOK

KAMER

With a fixed and a movable handle.

Sku. 104452  3 338020 002269

0,95 m 



NICKEL PLATED STEEL CATCH HOOK

KAMER

Made of nickel-plated steel. Use with a 28 mm diameter handle.

Sku. 104452100  3 338020 036837

Ø 28 mm 



ALUMINUM CATCH HOOK KAMER



Made of aluminium. Use with a 21 mm diameter handle.

Sk. 104452200 

Internal Ø 21 mm 

SHEPHERD STOVEL KAMER





Made of nickel-plated steel. Use with a 20 mm diameter handle.

Sk. 104452500 

Internal Ø 20 mm
Limited stock

RAM APRON KAMER

Prevents unwanted mating, Fastening strap made of nylon. Clip closing. Adjustable strap length. Width 60 cm and height 30 cm. Depending on availability.

Sk. 104452700 L 60 cm x H 30 cm  



HEAD GATE FOR SHEEP KAMER

Ideal for preparations for shows, shearing, styling, tattooing, identification, hoof care, replacing of a prolapse, difficult lambing or dosing. Robust and solid design. To fix on barriers, fences, grills or any other rails. Height adjustable by the slidable headpiece. Supplied with lanyard. Locking closure. Very practical to carry. For all sizes of animals. **It only weighs 7,5kg!** Structure of zinc-plated steel, ensures a long life time. **Works also for calves.**

Sk. 106901 

Minimum height 36 cm

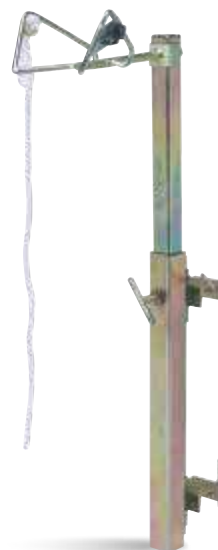

SHEEP HOOF SHEARS

KAMER

Large 6 cm replaceable blades. Lightweight and resistant. Thick aluminium handle for a better grip. The hoof shears of professionals!

Sku. 106607  3 338020 002450

Not serrated 6 cm 

Sku. 106607001  3 338020 034857

Serrated 6 cm 



SHEEP HOOF SHEARS

KAMER

Nickel-plated steel. Short or long blades, serrated or non serrated. Very resistant. Very nice finish.

Sku. 106605  3 338020 036707

Not serrated 6 cm 

Sku. 106605001  3 338020 038527

Serrated 6 cm 

Sku. 106606  3 338020 002443

Not serrated 8 cm 

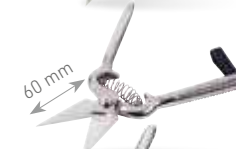
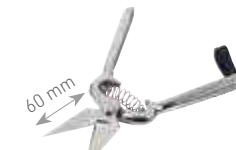

PREMIUM SHEEP HOOF SHEARS

KAMER

Non-serrated high-carbon steel blades - heat treated to cleanly cut even hard hooves. Does not rust, padded handle protects hand and joints. Easy action, one-handed locking device. Quality product, practical and lightweight shears for daily use.

Sku. 106605002  5 019360 200451

Not serrated 



FELCO HOOF SHEARS



They improve considerably the working conditions for the breeder. Increased efficiency due to the easy handling and exceptional cutting performance. Light forged metal handle. Lightweight and resistant. Xylan coated blades for better hygiene. Closing with rubber shock absorber. 2 models available: with a fixed handle and with a rotating handle (for an intensive use and saves effort).

Sku. 106608001  0 783929 100111

Rotating handle 

Sku. 106608002  0 783929 100128

Fixed handle 



SHEEP HOOF KNIFE



Steel blade. Ergonomic wooden handle for a better grip. Very nice finish.

Sku. 106612  3 338020 051915

Double blade 



BLACK BLUE HOOF KNIFE



High quality. One piece blade and handle. Black handle. Ergonomic shape. Treated steel blades. Available in different versions.

Sku. 106609BB4  3 338020 054947

Right fine blade 

Sku. 106609BB5  3 338020 055159

Left fine blade 



SHEEPS | Foot care and bells

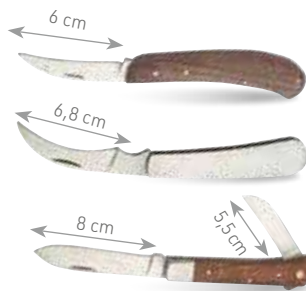

SHEPHERD'S KNIFE KAMER

Sku. 128300		1 x 6 cm blade	
Sku. 128301		1 x 6,8 cm blade	
Sku. 128302		2 blades 8 cm and 5,5 cm	

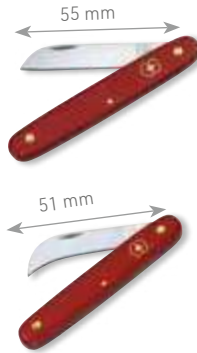

VICTORINOX SHEPHERD'S KNIFE

Original Victorinox Folding Knife. Length: 100 mm. Swiss quality.

Sku. 128303		Straight blade 55 mm	
Sku. 128304		Curved blade 51 mm	



WRAPPING SET

The essential kit for wrapping the legs of lambs and goats. Contains 2 strips of plaster 2 m x 10 cm and a jersey sock 2 m x 3 cm.

Sku. 106608100	Complete kit		
-----------------------	--------------	--	--

Bells

ROUND CAST BRASS BELL

KAMER

Alpine type bell for sheep. Clapper available on request.

Sku. 121800050	N°5 Ø 50 mm. Loop: 30 mm. Height: 35 mm		
Sku. 121800057	N°6 Ø 57 mm. Loop: 30 mm. Height: 40 mm		
Sku. 121800067	N°7 Ø 67 mm. Loop: 35 mm. Height: 50 mm		
Sku. 121800075	N°8 Ø 75 mm. Loop: 45 mm. Height: 55 mm		
Sku. 121800090	N°9 Ø 90 mm. Loop: 45 mm. Height: 65 mm		



ROUND STEEL BELL

KAMER

Bronze color. Traditional alpine and Jurassic bells for sheep and goats, type redon. Clapper available on request.

Sku. 121801045	Ø 45 mm. Loop: 30 mm. Height: 60 mm		
Sku. 121801055	Ø 55 mm. Loop: 38 mm. Height: 75 mm		
Sku. 121801060	Ø 60 mm. Loop: 42 mm. Height: 90 mm		
Sku. 121801080	Ø 75 mm. Loop: 42 mm. Height: 110 mm		







For spare parts, please contact us.

STRAIGHT STEEL BELL

KAMER

Bronze color.

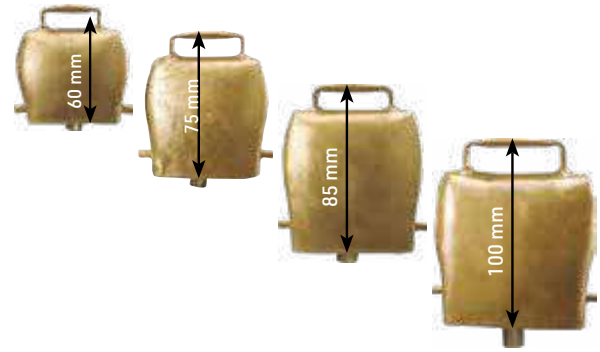

Sku. 121802055	Ø 55 mm. Loop: 35 mm. Height: 60 mm	3 338020 077007	
Sku. 121802065	Ø 65 mm. Loop: 43 mm. Height: 75 mm	3 338020 077014	
Sku. 121802075	Ø 75 mm. Loop: 50 mm. Height: 85 mm	3 338020 077021	
Sku. 121802090	Ø 90 mm. Loop: 60 mm. Height: 100 mm	3 338020 077038	



BLACK BLUE STEEL BELL



Steel bell for sheep and goats. Nice tone. Clapper available on request. (ref. 1218069064 and 1218069088). Please consult the list in the price list and on the website.

Sku. 121806064	Ø 64 mm. Loop: 50 mm. Height: 64 mm	3 338020 077649	
Sku. 121806088	Ø 88 mm. Loop: 50 mm. Height: 115 mm	3 338020 077434	



COPPER PLATED STEEL BELL

KAMER

3 types of traditional bell for cattle and goats.

Sku. 121807020		
80 x 95 mm		
Sku. 121807001		
50 x 50 mm. 9 mm loop		

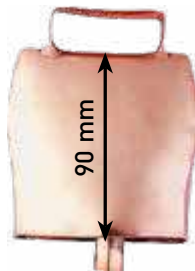

LEATHER COLLAR FOR SHEEP

KAMER

Buffalo leather.

Sku. 1211727055		
27 mm x 55 cm		
Sku. 1211747055		
47 mm x 55 cm		



Heiniger

Sheep shearing
machine

XPERT

2-SPEED

NEW!
2-SPEED

**Fast &
ergonomic**

Developed and manufactured
in Switzerland

High speed with
2500/2800
double strokes

Extremely
quiet

Lightweight,
small and ergonomically
shaped for comfort

Robust and
durable

Controlled
airflow

quality  swiss made

Int.Pat.Nr DM/078 110 EU
Pat.Nr. 138501 CH
Pat.Nr. 340969 AUS
Pat.Pending US/CN

Sku. 100279001



UKAL

—
PIGS

- 64 Feeding
- 64 Scalpel
- 62 Tooth cutting
- 65 Restraining

PIGS | Feeding, scalpel and tooth cutting

Feeding



FISH OIL WITH 100% COD LIVER OIL

UKAL

High quality nutritional supplement naturally rich in omega 3, in AD3E vitamins and essential fatty acid. Blends with traditional foods. Use daily or as a cure. **Contains 100 % cod liver oil.** Only for animal consumption. Our new formula contains winterized oil, much more digestible. Wintering consists of the cold filtration of oils.

Sku. 000100100	1 L		
Sku. 000500100	5 L		

Scalpel



SCALPEL HANDLE KAMER NO. 4

Accepts all scalpel blades for fixed handle no. 4. Sterilizable.

Sku. 102204

Fixed handle. Delivered by unit



SCALPEL BLADE KAMER NO. 22

Delivered in pack of 10.

Sku. 102206022

Box of 10

Tooth cutting



NICKEL-PLATED KAMER TOOTH CUTTING NIPPER

Nickel plated, length: 13 cm.

Sku. 105520

Cut length: 16 mm



STAINLESS STEEL KAMER TOOTH CUTTING NIPPER

Length: 13 cm. Stainless steel.

Sku. 105521

Cut length: 20 mm



Restraining

PIG HOLDER, SELF-LOCKING

KAMER

Heavy and very robust model. Self-locking loop. Reinforced loop and end. Cable easy to replace. 60 cm.

Sku. 105509001



3 338020 035106

60 cm. Nickel-plated metal and steel cable



Sku. 105509002



3 338020 058242

Pig catcher 60 cm, self locking



MINI ALUMINIUM PIG CATCHER

KAMER

Mini catcher. Molded aluminium handle. Safety device on restraining cable.

Sku. 105509005



3 338020 076680

Aluminium



PIG CATCHER WITH SLIP KNOT

KAMER

Steel cable. Large rubber handle that ensures a good grip. Not very cumbersome. 80 cm.

Sku. 105510



3 338020 002368

Nickel-plated
Limited stock



PIG STAPLES APPLICATOR

Aluminium screw to adjust the opening. Used to place the wire pig staples no. 3 (Sku. 105 504 003) and no. 4 (Sku. 105504004).

Sku. 105507



3 338020 002344

Aluminium



TRIANGULAR PIG STAPLES

Stop pigs from foraging on the ground. To be used with applicator Sku. 105507. Two sizes available. Delivered in pack of 100.

Sku. 105504003



3 338020 002320

3 cm / box of 100
Limited stock



Sku. 105504004



3 338020 002337

4 cm / box of 100



PIG RING APPLICATOR

For rings Sku. 105502. Nickel-plated steel. High quality. Robust.

Sku. 105503



3 338020 002313

Nickel-plated steel



NICKEL-PLATED STEEL PIG NOSE RINGS

High quality. Keeps a perfect circular shape after application. Self-locking. To be used with applicator 105503. Pack of 10.

Sku. 105502



3 338020 002306



Box of 10



HOT SHOT POWERMITE

Pocket powermite. Compact and robust. Works with 2 9V 5LF22 batteries (not included). Works even on wet animals.

Sku. 104405010  3 700393 929397

Works with 2 9V 5LF22 batteries (not included)   72



GUIDE PADDLE

With rattling noise. For guiding animals in an animal-friendly way. PVC handle and rubber arm.

Sku. 105511  4 014803 327512

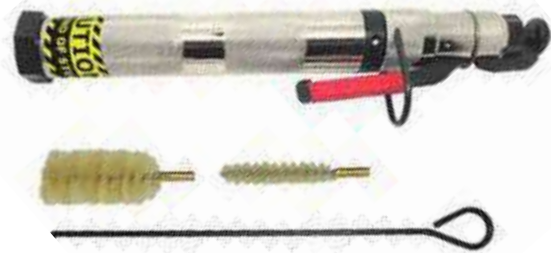

110 cm  20

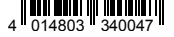

HOT SHOCK PLUS POWERMITE

Effective electric shock! Cuts off after 2 seconds in accordance with the latest animal protection law. Long life expectancy. Can also be operated with an extension handle. 5000 V max. voltage.

Sku. 104405020  4 014803 340047

Hot Shock Plus powermite   20



SCRATCHNALL™ PAD



Offers wellness for all kind of animals! Safe and effective way of self-scratching. No danger to skin, face and eyes. Durable quality. Flexible nubs for comfortable scratching. Unique interlocking design. Adjust the grooming surface as large as needed. Mounted individually or in groups flat on walls or around a corner. Can be folded on a 90° angle on corners.

Sku. 123340002  4 014803 307781

12,7 x 15,24 cm
Limited stock



NEW

BLITZ-KERNER CAPTIVE BOLT STUNNER

This German-made instrument uses powerful 9mm centerfire blank cartridges to deliver a dependable, effective and high-velocity penetration. A simple design and fewer internal parts mean this is a highly efficient, affordable and easy-to-maintain product. Centerfire cartridges hold higher pressures than rimfire cartridges, making them more powerful and efficient. It is a heavy-duty device that withstands rugged farm conditions. Bullets are not included.

Sku. 104460100  3 700393 978616

NEW

CARTRIDGE FOR CAPTIVE BOLT STUNNER

Sku. 104460203 For large oxen up to 650 kg red cartridges by 50  4 000294 174278

Sku. 104460206 For heavy animals (medium cattle, young bulls) - blue cartridges by 50  4 000294 174285

Sku. 104460208 For piglets (5-30 Kgs) and small animals (lambs, kids under 1 year old) - green cartridges by 50  4 000294 174261

Sku. 104460210 For sheep and goats, horses, fattening cattle and dairy cattle weighing less than 500 kg and beef cattle weighing less than 450 kg : yellow cartridges by 50  4 000294 174254



UKAL

—
HEATING

- 68 INTERHEAT
- 69 PHILIPS
- 69 HORIZONT

HEATING



3 wires

— INFRARED interHeat PROTECTORS - 250 W

Infrared protector, model meets CE standards and the French standard IPX4 (guaranteeing its compliance with sprinkling tests of electrical equipment). Usable with IR lamps from **100 to 250 W** and quartz reflectors. Ideal for keeping your chicks, calves, piglets and other animals warm under all circumstances. Delivered with attachment chain. 3 wires. Screwed sockets E27. Meets CE standards. 2 cable lengths available. Delivered not mounted.

Sk. 116602  8 809078 175014

Simple infrared protector 5 m of cable 

Sk. 116602001  8 809078 174017

Simple infrared protector 2,5 m of cable 

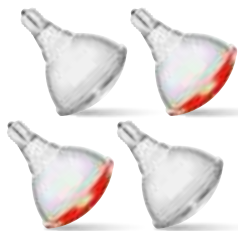

— IR LAMP interHeat

Experience shows that their life expectancy is greater than traditional infrared light bulbs. Infrared heating bulb, **captive screw base**, guaranteed for life. Provides a regular warmth and improves the conditions of breeding for young animals. **Available in PAR glass**. Set of 2.

Sk. 116622150R  8 809078 172068

IR lamp red 150 W **Limited stock** 

Sk. 116622175R  8 809078 172082

IR lamp red 175 W **Limited stock** 

Sk. 116622250R  8 809078 172105

IR lamp red 250 W **Limited stock** 

Sk. 116623100R  8 809078 176028

IR/PAR lamp screw red 100 W **Limited stock** 



— INFRARED interHeat PROTECTOR WITH DIMMER SWITCH - 250 W

Infrared protector, model meets CE standards and the French standard IPX4 (guaranteeing its compliance with sprinkling tests of electrical equipment). Usable with IR bulbs from **100 to 250 W**. Ideal for chicks, lambs, piglets etc. Delivered with attachment chain. 3 wires. E27 screw socket. Meets CE standards. Equipped with a dimmer switch and 5 m cable.

Sk. 116601  8 809078 175021

IR protector with dimmer switch 5 m of cable 



3 wires



— IR PROTECTOR IPX4 - 175 W

Aluminium lamp holder. Cable length: 2,5m. Chain length: 2m. This infrared protector meets CE standards. For lamps **up to 175 W**. Delivered in a box, unassembled.

Sk. 116605  3 275970 068689

IR protector 

Sk. 116605001  3 275970 068696

IR protector with dimmer switch 

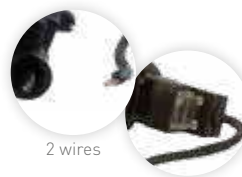

2 wires



— IR PROTECTOR IPX4 - 175 W

For normal or energy-saving infrared lamps with a maximum output of **175 Watts**. Rubber cord.

Sk. 116613  4 014803 326614

IR protection 5 m 

Sk. 116613001  3 700393 923111

IR protection 5 m with dimmer switch 



— IR PROTECTOR IPX4 - 250W

With ventilation slots for optimum air circulation. For normal or energy-saving infrared lamps up to **250 Watts**. Aluminium protection cage ø 21 cm with galvanised grid. Supplied with 2 m galvanised chain and ceiling hook (minimum suspension capacity 20 kg) GS/CE approved for more safety. Conforms to EN standard Splashproof (IPX4) with safety insulation E27 cap with silicone gasket. Set of 2.

Sk. 116610  3 700393 923128

IR protection 2,5 m 

IR LIGHT BULB



Incandescent infrared Philips reflector lamps are designed for the toughest environments: farms, bathrooms, kitchens. They offer a reinforced structure through the use of hard glass. Their compact form and base of universal cowling allows them to be used with any adaptive equipment. Thermal lamps are a great way to produce warmth. They provide direct warmth without draught to animals, people and food. Tungsten filament lamps for instant response, with an average lifetime of 5,000 hours. Available in classic or PAR glass.

Sku. 116400150C	
IR 100 W - white	
Sku. 116400150R	
150 W - red	
Sku. 116400250C	
IR 150 W - white	
Sku. 116400250R	
IR 250 W - red	

Sku. 116401100C	
IR PAR 100 W white	
Sku. 116401100R	
IR PAR 100 W red	
Sku. 116401175C	
IR PAR 175 W white	
Sku. 116401175R	
IR PAR 175 W red	



Advantages

- 90% of the energy is redistributed in infrared.
- Average lifetime of 5,000 hours.
- Instantly controllable radiant heat.
- Easy installation.

IR LIGHT BULB



Incandescent infrared reflector lamps are designed for the toughest environments: farms, bathrooms, kitchens. They offer a reinforced structure through the use of hard glass. Their compact form and base of universal cowling allows them to be used with any adaptive equipment. Thermal lamps are a great way to produce warmth. **Please use the proper lamp holder, especially for the 250 W.** They provide direct warmth without draught to animals, people and food. Tungsten filament lamps for instant response, with an average lifetime of 5,000 hours. Available in classic or PAR glass. Really good price/quality ratio.

Sku. 116404100C	
IR 100 W - white	
Sku. 116404150C	
IR 150 W - white	
Sku. 116404150R	
IR 150 W - red	
Sku. 116404175C	
IR 175 W - white	
Sku. 116404175R	
IR 175 W - red	
Sku. 116404250C	
IR 250 W - white	

Sku. 116404250R	
IR 250 W - red	
Sku. 116405100C	
IR PAR 100 W - white	
Sku. 116405100R	
IR PAR 100 W - red	
Sku. 116405175C	
IR PAR 175 W - white	
Sku. 116405175R	
IR PAR 175 W - red	





NEW RANGE OF BULBS AVAILABLE

Provide all the heating
needed by your animals!



FROM 100 W TO 250 W

White and red bulbs.

UKAL





UKAL

— IDENTIFICATION

- 72 Eartags
- 75 Collars and ankle straps
- 77 Temporary marking
- 79 Permanent marking

IDENTIFICATION | Eartags

HOW TO APPLY THE EARTAG CORRECTLY:

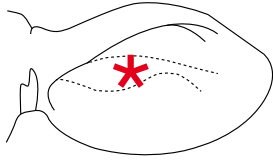

Always make a new hole. Dip the male tag into antiseptic or disinfectant solution. Make sure the male part is on back of ear. Avoid penetrating cartilage and blood vessels.

1 Super Maxi + Button

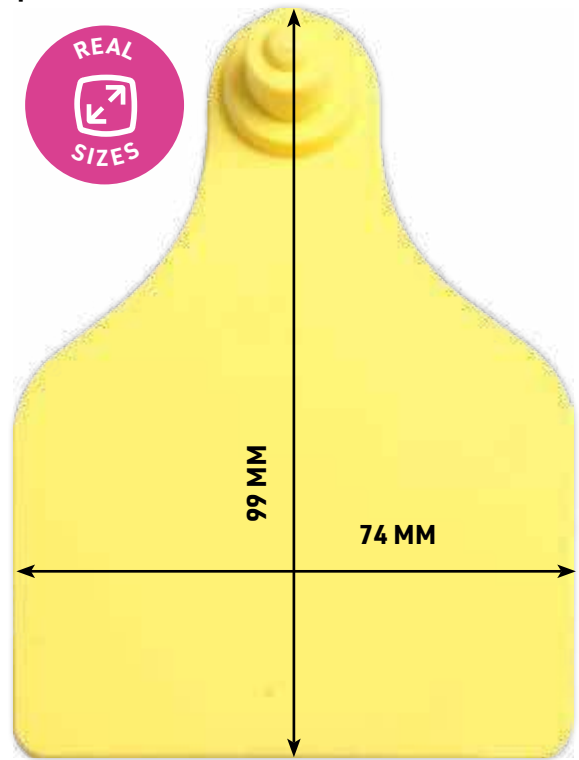

UKAFLEX MAXI + MAXI EARTAGS

Available in 8 sizes and 5 colors. Supplied in pack of 20 pairs. Can be marked with our different markers. For cattle, we recommend the size Maxi or Super Maxi. Metal pin. For more information, please have a look at the chapter on identification.



Type	Dimensions	Plain eartag white	Plain eartag red	Plain eartag blue	Plain eartag green	Plain eartag yellow	Printed laser 1 side	Printed laser 2 sides
1 Super Maxi + Button	99 x 74 mm	108068001	108068003	108068006	108068008	108068010	Upon request	Upon request
2 Maxi + Maxi	71 x 63 mm	108060001	108060003	108060006	108060008	108060010	108060100	108060200
3 Maxi + Button	Female part: 71 x 63 mm Male part: Ø 30 mm	108061001	108061003	108061006	108061008	108061010	108061100	108061200
4 Wide + Wide	45 x 55 mm	108063001	108063003	108063006	108063008	108063010	108063100	108063200
5 Wide + Button	Female part: 45 x 55 mm Male part: Ø 30 mm	108064001	108064003	108064006	108064008	108064010	108064100	108064200
6 Small + Small	45 x 55 mm Plastic pin	108066001	108066003	108066006	108066008	108066010	108066100	108066200
7 Button + Button	Ø 30 mm	108067001	108067003	108067006	108067008	108067010	-	-

2 Maxi + Maxi

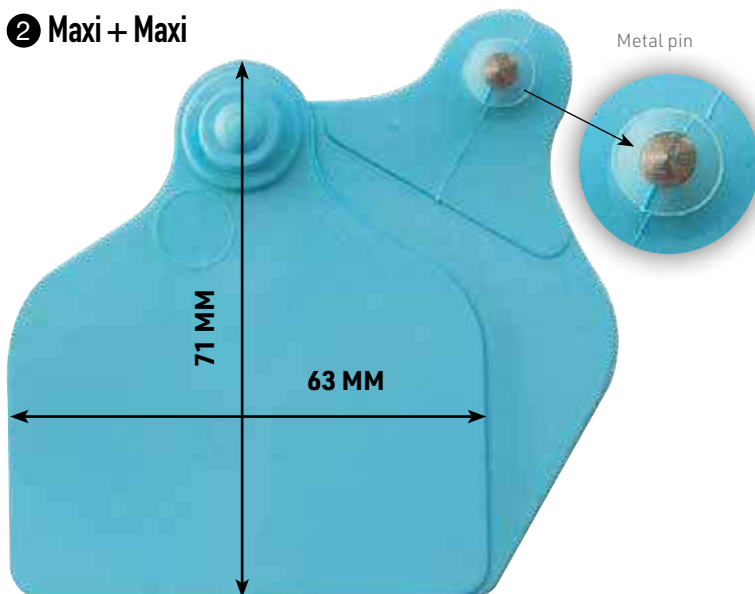

3 Maxi + Button

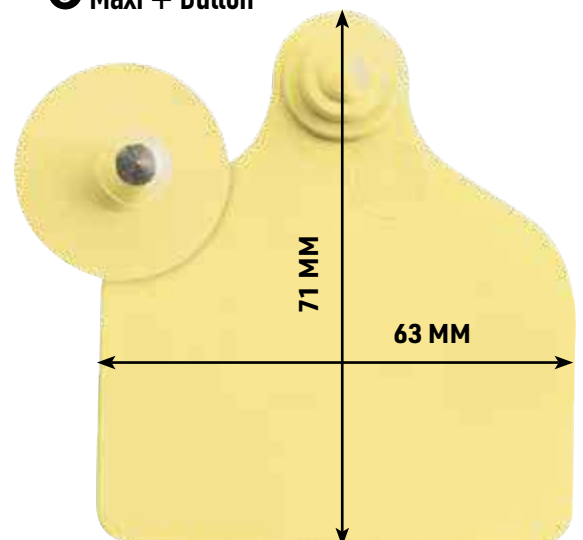

4 Wide + Wide

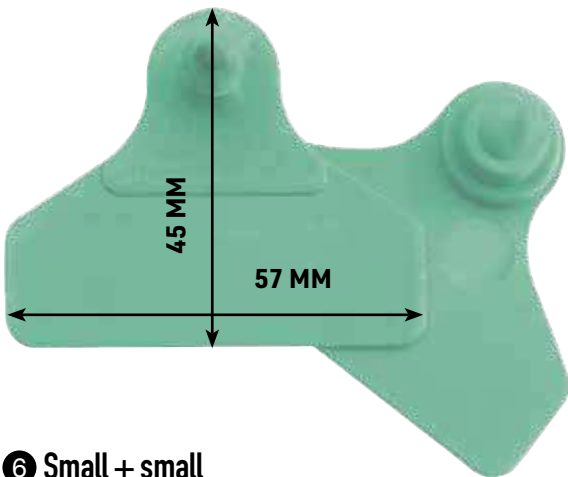

5 Wide + Button

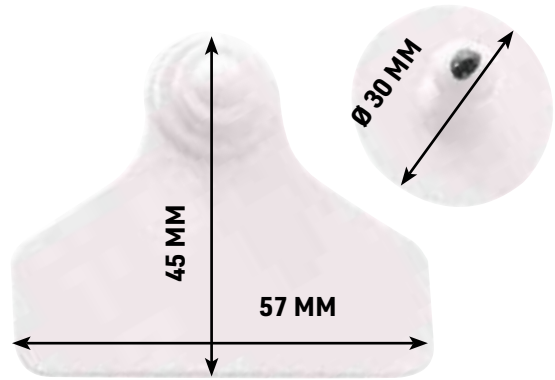

6 Small + small

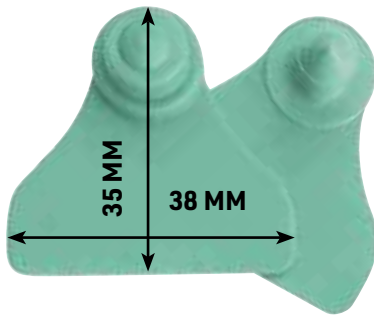

7 Button + Button



MAXI + MAXI

Eartags. By 20.

Sku. 108060001 

White 

Sku. 108060003 

Red 

Sku. 108060006 

Blue 

Sku. 108060008 

Green 

Sku. 108060010 

Yellow 

MAXI + BUTTON

Eartags. By 20.

Sku. 108061001 

White 

Sku. 108061003 

Red 

Sku. 108061006 

Blue 

Sku. 108061010 

Yellow 

SUPER MAXI + BUTTON

Eartags. By 20.

Sku. 108068001 

White 

Sku. 108068010 

Yellow 

Sku. 108068003 

Red 

Sku. 108068006 

Blue 

Sku. 108068008 

Green 

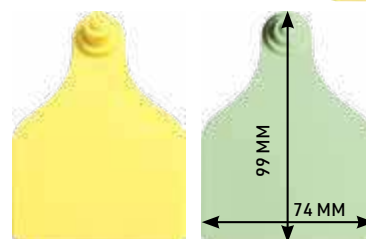
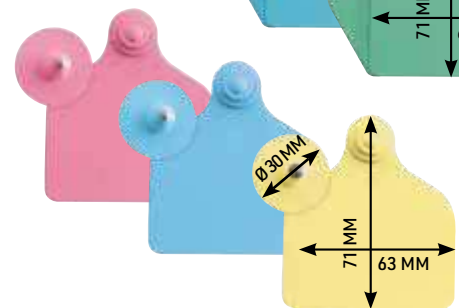
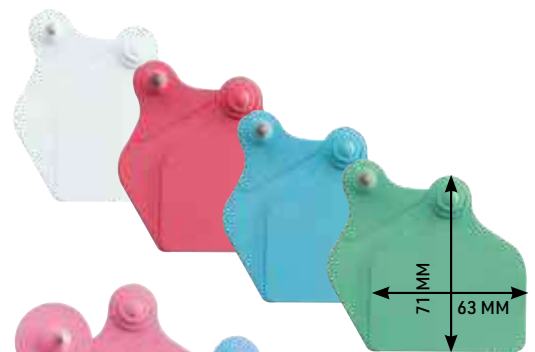

Super Maxi + Button

IDENTIFICATION | Eartags

APPLICATOR FOR UKAFLEX EARTAGS



Complete with 2 universal pins. Can be used with most cattle eartags on the market. Can be used to apply Ukal-Flex, Kelflex and Allflex eartags.

Sku. 108000		3 338020 003020
Applicator with 2 universal pins		
Sku. 108000002		3 700393 930904
Universal pin x 2		

BLACK MARKER



Smear proof markers to mark sheep collars, neck tags, ankle straps and all kinds of eartags. Reistant to contact with organic matter, bases and acids.

Sku. 108280001		0 048615 960234
Fine tip		
Sku. 108280003		3 660447 100755
Round tip		

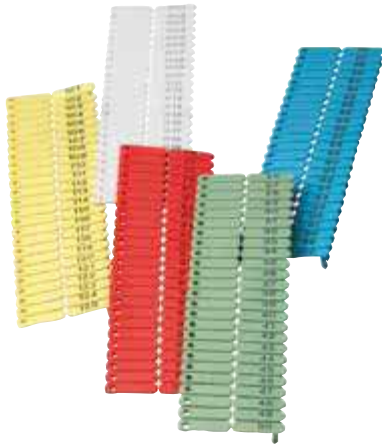

UKALTAG EARTAGS

UKAL

Ukaltag eartags are made of high quality nylon (nylon 6-6). The standard version of the eartags is available in several U.V. resistant colours. Dimensions: 3 x 1 cm. **Special printings can be made on request.** Tags can be printed on both sides as follows: - consecutive numbers. - 8 fixed numbers. - 8 fixed characters (letters, numbers). Supplied by 100 pairs.

PRINTING FROM 1 TO 100

	Sku. 109922001		3 338020 007783
	Sku. 109922003		3 338020 007806
	Sku. 109922006		3 338020 007820
	Sku. 109922008		3 338020 007837
	Sku. 109922010		3 338020 007844

PRINTING FROM 101 TO 200

	Sku. 109922101		3 338020 007882
	Sku. 109922103		3 338020 007905
	Sku. 109922106		3 338020 007929
	Sku. 109922108		3 338020 007936
	Sku. 109922110		3 338020 051571

LASER PRINTING 1 OR 2 SIDES

	Sku. 109922701		3 338020 078936
	Sku. 109922703		3 338020 078943
	Sku. 109922706		3 338020 078950
	Sku. 109922708		3 338020 078967
	Sku. 109922710		3 338020 078974



UKALTAG APPLICATOR

UKAL

Can be used with most sheep eartags available on the market.

Sku. 109925	Metal		3 338020 008087
--------------------	-------	--	-----------------



PLASTIC COLLAR FOR SHEEPS

KAMER



Very solid and resistant to chemicals. With safety catch fastening. Can be marked with marking pen. Length: 57,5 cm. Available by box of 50 also. Made in Europe.

	Sku. 121150010	Yellow		3 700393 961458	
	Sku. 121150003	Red		3 700393 961496	
	Sku. 121150019	Orange		3 700393 961472	
	Sku. 121150006	Blue		3 700393 961373	
	Sku. 121150008	Green		3 700393 961533	
	Sku. 121150002	Black		3 700393 961519	
	Sku. 121150021	Salmon		3 700393 929618	

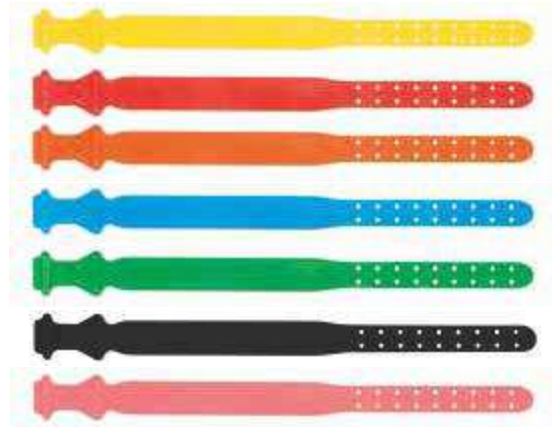

NYLON COLLAR FOR SHEEPS

KAMER



Adjustable. With D-ring to put a lanyard. Very sturdy and reinforced leather, they are suitable for all types of sheep. Length about 65 cm. Width: 2,5 cm. By unit. Made in Europe.

	Sku. 121152006	Blue		3 700393 922152	
	Sku. 121152008	Green		3 700393 922169	
	Sku. 121152010	Yellow		3 700393 922145	



SELF-ADHESIVE FLUORESCENT ANKLE STRAP FOR COWS

KAMER



Very resistant and easy to put on and remove. Better hold due to a plastic loop. Allows a fast identification of the cow and udder (1 leg = 1 teat). Facilitates use of colour coding in case of any treatment. Fluorescent colours for a very good visibility. Long. Sold in bag of 5 ankle straps. Dimensions: 3,8 x 41 cm.

	Sku. 108701008	Fluorescent Green By 5		3 338020 086320	
	Sku. 108701010	Fluorescent Yellow By 5		3 338020 086306	
	Sku. 108701019	Fluorescent Orange - By 5		3 338020 086313	
	Sku. 108701021	Fluorescent Pink By 5		3 338020 086337	



NEW

PLASTIC STRAP FOR COWS

KAMER



Extra long model. Easy to use. Precise tightening by non-return catch. Use these bright neon coloured straps for all temporary i.d. needs. Approx. 340 mm long. In pack of 10.

	Sku. 108811003	Fluorescent Cherry By 10		3 700393 923241	
	Sku. 108811008	Fluorescent Green By 10		3 700393 923265	
	Sku. 108811010	Fluorescent Yellow By 10		3 700393 923272	



IDENTIFICATION | Collars and ankle straps



NYLON COW COLLAR

KAMER

Can be used with strap digits. Nice finish. Length: 120 cm. By unit. Made in Europe.

	Sku. 121160	Yellow and black	3 338020 058631	
	Sku. 121160003	Red	3 338020 058648	
	Sku. 121160006	Blue	3 338020 058655	
	Sku. 121160008	Green	3 338020 058662	



PLASTIC IDENTIFICATION STRAP DIGITS

KAMER

Fits on most collars, halters, straps. Each digit is 4 cm - 2" high. Printed with 1 digit. In pack of 10.

Sku. 108906050	0	3 700393 926402	
Sku. 108906051	1	3 700393 926419	
Sku. 108906052	2	3 700393 926440	
Sku. 108906053	3	3 700393 926464	
Sku. 108906054	4	3 700393 926471	
Sku. 108906055	5	3 700393 926488	
Sku. 108906056	6/9	3 700393 926495	
Sku. 108906057	7	3 700393 926501	
Sku. 108906058	8	3 700393 926518	



MULTI-LINE MARKING SPRAY

Livestock spray marker specifically formulated for short-haired animals. Non aggressive formula. Box of 12. 500 ml.



Sku. 108312103		3 338020 045563	
Red			12
Sku. 108312106		3 338020 045570	
Blue			12
Sku. 108312108		3 338020 045587	
Green			12

MARKING SPRAY

RAIDEX

Specifically formulated for marking cattle, pigs, and short-haired animals. Delivered in box of 12. 500 ml.



Sku. 108307003		4 019726 005332	
Red			12
Sku. 108307006		4 019726 005356	
Blue			12
Sku. 108307008		4 019726 005363	
Green			12



OVI-LINE MARKING SPRAY

High quality formula specifically for marking wool, long or short. Long lasting (2 months). **Composition: contains lanolin.** The Ovi-line spray meets the highest standards of the wool industry. The quality of the paint and lanolin-based marker allows for legible and long-lasting marking (2-3 months). The Ovi-line spray is the only spray which allows the mother and lamb to be marked at lambing with a quantity comparable to paint marking. To mark a number with the spray, hold the tip 5-6 cm from the fleece and write the number by moving the can like a marker. 500 ml. Delivered in box of 12.



Sku. 108316003		3 338020 042432	
Red			12
Sku. 108316006		3 338020 042449	
Blue			12
Sku. 108316008		3 338020 042456	
Green			12

MARKING SPRAY RAIDEX FOR SHEEP

RAIDEX

RAIDEX sheep marking spray is suitable for marking sheep and lambs. It is an advancement of the established RAIDEX sheep branding fluid and offers improved drying and washability. It contains harmless, light-fast pigments, mildly-odorous solvent, lanolin grease and natural resins. This composition achieves good drying and removal during the wool wash. 500 ml. Supplied by box of 12. The markings/numbers are applied by spraying from a distance of 10-15 cm. RAIDEX sheep branding fluid dries within 4 to 8 hours depending on ambient temperature and consistency of the dye. As these fluids take several hours to dry, care must be taken to prevent contact with the dye and hence smudging. The dye markings wash out if conventional wool washing is employed. The dye markings should be left on the animal for approx. 4-6 weeks in order to guarantee washability. Ensure that the markings are applied to sheep in an appropriate place, e.g. head or legs.



Sku. 108308002		4 019726 054088		Sku. 108308020		4 019726 054040	
Black			12	Purple			12
Sku. 108308003		4 019726 054033		Sku. 108308021		4 019726 054071	
Red			12	Pink			12
Sku. 108308006		4 019726 054057					
Blue			12				
Sku. 108308008		4 019726 054064					
Green			12				
Sku. 108308010		4 019726 054019					
Yellow			12				
Sku. 108308019		4 019726 054026					
Orange			12				

IDENTIFICATION | Temporary marking



RAIDEX MARKING STICK

RAIDEX



Sticks made of special waxes and paraffin oil. We use high-quality pigments to achieve an excellent colour quality. The sticks are set apart by effective writing capability on hide, temperature stability, colour intensity and high luminance. The ingredients are harmless for humans or animals. By 3 (108303003 to 108303020), by 10 (108304002 to 108303020) and by 50 (108305021). Packaging and any unused materials can be discarded with residual waste. The marking remains visible on the upper back of cattle and sheep for approx. four weeks. Please note that markings on sheep are impossible or difficult to wash out. They should therefore be applied in a more suitable place, e.g. head or legs.



Sku. 108303003		Sku. 108303020	
Red - By 3		Purple - By 3	
Sku. 108303006		Sku. 108303100	
Blue - By 3		Red - Blue - Green	
Sku. 108303008		Sku. 108304002	
Green - By 3		Black - By 10	

Sku. 108304003		Sku. 108304010	
Red - By 10		Yellow - By 10	
Sku. 108304006		Sku. 108304019	
Blue - By 10		Orange - By 10	
Sku. 108304008		Sku. 108304020	
Green - By 10		Purple - By 10	



BLOCK FOR HARNESS

RAIDEX



RAIDEX wax blocks consist of high-quality special waxes and paraffin oil. We use high-quality pigments to achieve an excellent colour quality. The ingredients are harmless for humans or animals. RAIDEX wax blocks can be used at any temperature without any problem. To be stored between 5 and 25 degrees. For cattle and sheep.

Sku. 108601002		Sku. 108601008	
Black		Green	
Sku. 108601003		Sku. 108601010	
Red		Yellow	
Sku. 108601006		Sku. 108601019	
Blue		Orange	



SUPER BLUE HARNESS FOR RAMS

KAMER



The new Super blue harness has been specially designed by animal breeders. Easy to use and to adjust. Very resistant. Easy maintenance. Padded straps prevent cuts and chafing. Nylon.

Sku. 108605006	
Nylon	



HARNESS FOR RAMS

KAMER



The new Super blue harness has been specially designed by animal breeders. Easy to use and to adjust. Very resistant. Easy maintenance. Padded straps prevent cuts and chafing. Nylon.

Sku. 108605	
Nylon	



EAR NOTCHER

KAMER





Nickel-plated steel. Very sharp for a neat cutting. Available in 5 shapes.

Sku. 108400010	10N		
Sku. 108400011	11N		
Sku. 108400012	12N		
Sku. 108400013	13N		
Sku. 108400014	14N		

SHEEP MARKING FLUID

To be used with marking numbers (Sku. 108430-440). Specific composition which respects the wool. Completely washable, leaves no residue in the wool. 4 kg container.



	Sku. 108455003	Red		
	Sku. 108455006	Blue		
	Sku. 108455008	Green		

MARKING NUMBERS 0-9

KAMER

Only to be used with Master laine sheep marking fluid. Made of aluminium (Sku. 108455003, -006, -008). Set of 9 number from 0 to 9 (6 and 9 are the same). Available in 2 sizes.



Sku. 108430	8 cm	
Sku. 108440	10 cm	



Permanent marking

BLACK TATTOOING PASTE **RAIDEX**

Veterinary quality paste. Can be applied with finger. Massage areas to be tattooed with paste. Black.

Sku. 109175600 

600 g jar



BLACK TATTOOING INK

UKAL

High quality tattooing ink, intense black. Apply with a small brush on area to be tattooed or used in the ink pad for pig tattooing hammers. Ready to use. Density 1,24/1,25 g/liter.

Sku. 109946100 

1 L





UKAL

— ELECTRIC CLIPPING

- 82 Clippers for cattle and horse
- 84 Blades for cattle and horse
- 84 Clippers for sheeps
- 86 Combs for sheeps
- 90 Trimmers
- 92 Blades
- 93 Accessories and care



HEINIGER IS THE WORLD NUMBER 1 IN ANIMAL SHEARING

Founded in 1946, Heiniger quickly established a good reputation as a manufacturer of quality products and agricultural services. Following the great success of exports, the product range and sales were widened. Worldwide, millions of animals are shorn with Heiniger products. Heiniger instruments are designed for precise shearing, clean and fast. Each shear corresponds to a type of animal so that all clippings, even the most difficult, can be easily accomplished with the right tools. Discover the range, perfect for shearing your horse, cattle, sheep with a 2 year warranty provided by UKAL Livestock France. A 30 years partnership.

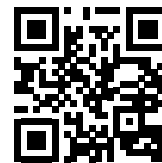

DISCOVER OUR WEBSITE

www.heiniger.fr



XPERIENCE ELECTRIC CLIPPER 2 SPEEDS



The XPERIENCE clipper is the perfect balance between power and lightness. It will fulfil all your shearing needs for horses and cattle. Thanks to its unique ergonomic design, it ensures a perfect grip making for fatigue-free working. The innovative connecting system between the cutting head and the reinforced body, coupled with a powerful engine, ensure a long-life use. Light, sleek and silent. The XPERIENCE clipper will satisfy your needs of quality, style and precision. Supplied in a box including operating instructions, screwdriver, cleaning brush, oil. **Power: 250 W. Weight: 1180 g. Noise: 68 dB(A). Motor speed: 2600/2900 rpm. Power supply: 240 V. Supplied with 21 and 23 teeth blade set/ screwdriver/brush/oil.**

Sku. 100272001

On mains



CORDLESS CATTLE XPLORER



The Xplorer accumulator clipper is the latest technological innovation. The perfect tool for cattle and horse clipping. Wireless, it has up to 2 hours run time and offers more flexibility thanks to its wireless system. Practical thanks to LED charging indicator. No disturbing air output. No power loss due to the development of the dual pinion drive. Strong and durable thanks to its fibreglass reinforcement. The Xplorer clipper meets all requirements in the field of shearing horses and cattle. **2600mAh Li-Ion battery with no memory effect.** Li-Ion high performance 3-cell. Safety certification: CE/electrosuisse Delivered in a box including operating instructions, screwdriver, cleaning brush, oil. **Fitted with a 21/23 teeth combs set. Weight: 990 g. Noise: 65 dB(A).**

Sku. 100264

Supplied with
1 battery + 1 charger



Sku. 100264001

1 extra battery



NEW

CORDLESS XPLORER PRO - 2 SPEEDS

heiniger



Heiniger revolutionises cattle and horse clipping with its new XplorerPro clipper. Ever more powerful than its predecessor, the XplorerPro features two speeds and is the only clipper to date to include a patented clipping pressure display. This guarantees more precise clipping than ever before and also extends the clipper's life.

Delivered with a carrying case including a set of 21/23 teeth combs, instructions for use, screwdriver, cleaning brush, oil and a charging station.

Features:

- **2 speeds: 2450 et 2 900 double strokes per minute**
- Battery capacity: 2850 mAh
- Battery run time: approx. 120 min
- Battery charging time: approx. 90 min
- Sound pressure level: approx. 65 dB
- Integrated battery charge indicator
- Handy and light: 975 g
- Length: 300 mm

2 YEARS WARRANTY.



Sku. 100264004 Supplied with 1 battery + 1 charger 7 613073 065581

Sku. 100264005 1 extra battery 7 613073 063846

PROGRESS - ELECTRIC CLIPPER FOR HORSE

heiniger



Equipped with last generation electronic features, the Progress clipper is now even more powerful and user-friendly. Thanks to its ultra-streamlined handle, its light weight and its low-noise running, it is the best solution for nervous horses shearing. Particularly well suited to women's hands. Adaptable with combs from the other clippers. Also suitable for cattle finishing touch. Performance: 80 W. Speed: 2200 oscillations/min. Length: 280 mm. 5 m wire. Weight: 930 g. Noise emission: 70 dB. **Mounted with: 31/15 teeth combs.** Supplied in a storage box with instruction manual, screwdriver, cleaning brush and oil.



Sku. 100268 On mains 3 338020 087570

TAILWELL MK2

The use of Tailwell 2 facilitates shearing cows tail hair to ensure optimum hygiene of the cattle. Silent, fast and safe shearing. Works with 14V cordless screwdrivers, 1250 rpm. Supplied with the cutting head, 1 bottle of lubricant for the blades and 1 syringe for the lubricant. Supplied without screwdriver.



Sku. D100500 9 417027 206703



DISCOVER THE VIDEO

ELECTRIC CLIPPERS | Blades for cattle and horse ans clippers for sheeps



FAST CLIPPING



Sku. 100246SET



Blade set 18
and 23 teeth



SPECIAL BLADE SET CHAROLAIS



Sku. 100242SET



Blade set 18
and 15 teeth



Sku. 100247015



15 teeth cutter



ALL-ROUND BLADE SET FOR CATTLE



Sku. 100244SET



Blade set 21
and 23 teeth



Sku. 100246



21 teeth comb



Sku. 100245



23 teeth cutter



BLADE FOR VETERINARY USE



Sku. 100241SET



Blade set 53
and 23 teeth



Sku. 100241053



53 teeth comb



Sku. 100245



23-teeth cutter



Clippers for sheeps



XPERT SHEARING 240 V 2 SPEEDS



The latest machine by Heiniger, Xpert is a powerful, yet still ergonomic and lightweight machine. **2 speeds.** The unique, innovative, stable connection between the shearing head and the fibreglass-reinforced housing ensures low vibration shearing. Silent. This shearing machine will amaze anyone who shears. Supplied in an extra-strong carrying case including a set of combs, screw driver, oil bottle, brush and user manual. Manufactured in Switzerland. **Fitted with OVINA PREMIUM comb set. Weight: 1180 g, noise: 79 dB. Power supply: 240 V / 200 W. Motor speed: 2500/2800 rpm.**

Sku. 100279001 On mains



SHEEP CLIPPER XTRA 320 W



Large head, powerful engine. Equipped with an exclusive clipping system. Less vibrations. The motor consists of a 320 watts and 2400 cycles per minute. The sheep clipper is equipped with a large head and comes with Ovina Premium. This powerful electric HEINIGER sheep clipper is supplied in a case. Weight: 1530 g. Noise: 80 dB. Power supply: 220-240 V.

Sku. 100280 On mains



Sku. 100281 Shearing head only



Sku. 100145 Motor only



Sku. 9H100280 Maintenance kit for sheep clipper XTRA 10 control points



ONE PROFESSIONAL SHEARING PLANT 300 W



Ideal for shearing big herds. Thanks to its ICON handpiece the ONE shearing plant is very compact and easy to handle. The powerful electric motor allows you to shear sheep and goats. Supplied with a flexible shaft of 200 cm and ICON handpiece. Available in WORM DRIVE or PIN DRIVE. **Color non contractual.**

Sku. 100123001	ONE professional shearing plant 300 W WORM DRIVE		7 613073 002272
Sku. 100123002	ONE professional shearing plant 300 W PIN DRIVE		3 700393 903861
Sku. 100123005	Wall mount		3 338020 081363



PIN DRIVE



WORM DRIVE

EVO PROFESSIONAL SHEARING PLANT 300 W



The HEINIGER professional shearing plant is the only one in the world equipped with an electrical safety device with an international ratification certificate. **3 speeds:** 2700, 3200 and 3500 rpm. An autoadjustable belt ensures the transmission. It is protected by a very sturdy case made of synthetic material reinforced by fiberglass. **Color non contractual.** Noise: 70 dB.

Sku. 100124100	EVO professional shearing plant 300 WORM DRIVE		7 613073 000391
Sku. 100124200	EVO professional shearing plant 300 PIN DRIVE		3 338020 084128
Sku. 100124101	Flexible shaft WORM DRIVE		3 338020 084135
Sku. 100124201	Flexible shaft PIN DRIVE		3 338020 084142



PIN DRIVE



WORM DRIVE

ICON HANDPIECE FOR PROFESSIONAL SHEARING PLANTS



Quality handpiece provides top professional shearing. Ergonomical form for a better grip or handle. Supplied without comb and cutter. **Color non contractual.**

Sku. 100122030		3 338020 039715
-----------------------	--	-----------------

PIN DRIVE



Sku. 100122031		3 338020 079100
-----------------------	--	-----------------

WORM DRIVE



ICON FX - HANDPIECE



The significantly lighter weight requires less energy to stop momentum and minimises the effort required for every blow. The slimmer shape barrel ensures a superb grip and provides maximum in-hand comfort. The precise weight distribution provides superior balance and handling to deliver easier manoeuvrability. 10 % lighter handpiece. Now even slimmer. Optimum balance. Ergonomic.

Sku. 100122302		7 613073 059863
-----------------------	--	-----------------

WORM DRIVE



ELECTRIC CLIPPERS | Combs for sheep clippers





UKAL RECOMMENDS THE WORM DRIVE TIP FOR MORE SECURITY

EVO PROFESSIONAL SHEARING PLANT WITH RIGID SHAFT



Comes with rigid shaft WORM-DRIVE and ICON handpiece. 3 speeds: 2700, 3200 and 3500 rpm.

Sku. 100124300 EVO with shaft 

Sku. 100122020 Shaft only 

Combs





FINE WOOL AND DENSE FLEECE



Specially designed for shearing animals with fine wool or dense fleece such as sheep or goats. 13 high-quality teeth for easy shearing. Used by experienced shearers.

Sku. 100255SET 

13 and 4 teeth blade set 

Sku. 100256 

13 teeth comb 

Sku. 100253 

4 teeth cutter 



CLASSIC SHEARING & PREMIUM



For Heiniger sheep clippers. Classic shearing and fine wool and dense fleece. The Ovina Premium comb set is equipped with the new LG2 technology.

Sku. 100252SET 

13 and 4 teeth blade set 

Sku. 100254 

13 teeth comb 

Sku. 100253 

4 teeth cutter 

Sku. 100253SET 

Ovina Premium blade set 



ESPECIALLY FOR CATTLE



Heiniger clipper comb, specially designed for shearing cattle. 25 and 4 tooth blade set. **Only works on sheep clippers.**

Sku. 100257SET 

25 and 4 teeth blade set 



ESPECIALLY FOR MERINO WOOL



Sku. 100261SET 

13 and 4 teeth blade set 



ESPECIALLY FOR CAMELIDS



Sku. 100256SET 

13 and 4 teeth blade set 



Combs for winter shearing

PRO BLIZZARD COMB



Box of 2 combs.

Sku. 100100018



Size: 94,5 mm



HIGHLANDER COMB



Box of 2 combs.

Sku. 100100042



Size: 98 mm



ISOBAR COMB



Box of 2 combs.

Sku. 100100041



Size: 98 mm



CRUSADER COMB



Box of 2 combs.

Sku. 100100043



Size: 94,5 mm



Cutters

XTREME CUTTER



Box of 10 combs.

Sku. 100100106



Size: 3,7 mm



PRO JET CUTTER



Box of 10 combs.

Sku. 100100100



Size: 4,4 mm



STORM CUTTER



Box of 10 combs.

Sku. 100100107



Size: 4,6 mm



DIAMOND CUTTER



Box of 10 combs.

Sku. 100100102



Size: 3,7 mm

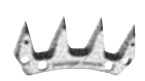

EDGE CUTTER



Box of 10 combs.

Sku. 100100108



Size: 4,4 mm

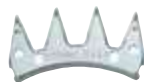

For broad wool



CHARGER COMB

Box of 5 combs.



Sku. 100100016 3 338020 063079

Size: 93,5 mm.
Right hand

Sku. 100100017 3 338020 063086

Size: 93,5 mm.
Left hand



SUPER CHARGED COMB

Box of 5 combs.



Sku. 100100006 3 700393 922961

Size: 93,5 mm



WARRIOR COMB

Box of 5 combs.



Sku. 100100001 3 338020 063048

Size: 96 mm



QUANTUM COMB

Box of 5 combs.



Sku. 100100012 3 700393 922978

Size: 95 mm.
Right hand



QUAZARD COMB

Box of 5 combs.



Sku. 100100005 7 613073 000032

Size: 95 mm



CONDOR COMB

Box of 5 combs.



Sku. 100100024 3 700393 922992

Size: 98 mm



CALIBRE COMB

Box of 5 combs.



Sku. 100100044 3 700393 923692

Size: 93,5 mm



XLR-8 COMB

Box of 5 combs.



Sku. 100100039 3 700393 923005

Size: 98 mm

For fine wool



PRO AWESOME COMB

Box of 5 combs.



Sku. 100100010 3 338020 062676

Size: 92 mm























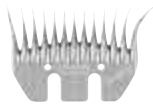









XPRESS COMB

Box of 5 combs.























Sku. 100100009 3 338020 062669













Size: 93,5 mm

<p>FREESTYLE COMB </p> <p>Box of 5 combs.</p> <p>Sku. 100100036  3 338020 089475</p> <p>Size: 96 mm. Right hand</p> <p>Sku. 100100046  3 700393 931611</p> <p>Size: 96 mm. Left hand</p>	  	<p>HUGE COMB </p> <p>Box of 5 combs.</p> <p>Sku. 100100029  3 700393 921360</p> <p>Size: 96 mm</p>	  
<p>PRO REBEL COMB </p> <p>Box of 5 combs.</p> <p>Sku. 100100032  3 338020 083480</p> <p>Size: 92 mm</p>	  	<p>BAD COMB </p> <p>Box of 5 combs.</p> <p>Sku. 100100004  3 700393 922954</p> <p>Size: 95 mm</p>	  
<p>FREAK COMB </p> <p>Box of 5 combs.</p> <p>Sku. 100100034  3 338020 084272</p> <p>Size: 94,5 mm</p>	  	<p>B-EVIL COMB </p> <p>Box of 5 combs.</p> <p>Sku. 100100002  3 700393 922947</p> <p>Size: 94,5 mm</p>	  

Universal comb

<p>PRO RAPIER COMB </p> <p>Box of 5 combs.</p> <p>Sku. 100100021  3 338020 063123</p> <p>Size: 86 mm</p>	  	<p>REFLEX COMB </p> <p>Box of 5 combs.</p> <p>Sku. 100100037  7 613073 000896</p> <p>Size: 94 mm</p>	  
<p>PRO LEGEND COMB </p> <p>Box of 5 combs.</p> <p>Sku. 100100014  7 613073 000209</p> <p>Size: 92 mm</p>	  	<p>PROFLEX COMB </p> <p>Box of 5 combs.</p> <p>Sku. 100100038  7 613073 006065</p> <p>Size: 94 mm</p>	  

ELECTRIC CLIPPERS | Combs

		PRO OVINA COMB 			OVINA PREMIUM COMB 
		Box of 5 combs.			Box of 5 combs.
		Sku. 100100025 			Sku. 100100028 
		Size: 77 mm			comb with LG2 technology. Ovina Full thickness. 77 mm wide / Medium Bevel
		TOPAZ COMB 			
		Box of 5 combs.			
		Sku. 100100030 			
		Size: 84,5 mm			

Saphir clippers



CORDLESS PROFESSIONAL TRIMMING CLIPPER SAPHIR

For small animals and veterinary care. Up to 90min clipping time per battery with high performance lithium-ion technology. Additional battery pack and less than 60 min charging time for continuous clipping. The perfect clipping machine for trimming cattle or for Cow-Styling. Detachable Saphir blade system compatible with clippers from Andis, Moser, Oster and Wahl. Supplied with clipping blades, 2 batteries, charger unit, oil, brush and instruction manual. Power: 35 W. Weight: 440 g. Noise: 63 dB. **Motor speed: 2650 rpm.** Dimensions: 204 x 50 x 41 mm.

Sku. 154400 2 batteries 



SAPHIR STYLE CORDLESS PROFESSIONAL TRIMMING CLIPPER

For small animals and veterinary care. Low-noise and high-performance 35 W permanent magnet motor. High performance battery with the latest lithium-ion technology for continuous clipping. Over 90 minutes of clipping time with less than 60 minutes of charging time. Highquality charger with additional charging dock for 2 batteries and with charging indicator. Large selection of interchangeable clipping blades, compatible with Andis, Moser, Oster and Wahl. Supplied with clipping blades, two batteries, charger unit, oil, brush and instruction manual. Power: 35 W. Weight: 440g. Noise: 63 dB. **Motor speed: 2650 rpm.** Dimensions: 204 x 50 x 41 mm

Sku. 154405 2 batteries 

SAPHIR CORD PROFESSIONAL CLIPPER



For small animals and veterinary care. The latest technology coupled with a new design. A clipper with exceptional technical qualities specifically developed for shearing small animals. A wide selection of interchangeable cutting heads. A powerful and innovative clipper that is quickly becoming an essential tool for the professional shearing of small animals. Operates on mains power, with 3 m of cable. Power: 35 W. Weight: 330 g. Noise: 63 dB. **Motor speed: 3200 rpm.** Dimensions: 204 x 50 x 41 mm. Operates on mains power with 3 m of cable.

Sku. 154410

On mains



CORDLESS PROFESSIONAL TRIMMING CLIPPER SAPHIR BASIC



For small animals and veterinary care. Up to **90 minutes** clipping time per battery with high performance lithium-ionic technology. The perfect clipping machine for the trimming of cattle and horses or for cow-styling. Detachable Saphir blade systems compatible with clippers from Andis, Moser, Oster and Wahl. Supplied in a resistant and practical case, with clipping blades, 1 battery, oil, brush and instruction manual. Power: 35 W. Weight: 440 g. **Motor speed: 2650 rpm.** Dimensions: 204 x 50 x 41 mm. Noise: 63 dB.

Sku. 154415

1 battery



CORDLESS BATTERY 2 SPEEDS CLIPPER OPAL



The Opal is extremely quiet. It is also impressively powerful and equipped with **two speed levels**. With 3100 oscillations per minute in fast mode (and 2600 in slow mode), this clipper works smoothly and quickly even through dirty and thick fur and hair. The latest lithium-ion battery technology ensures cordless clipping **for 240 minutes**. It takes just one hour for a full battery recharge. Thanks to the built-in battery level indicator, it is always possible to check the remaining battery time. Opal has a cutting-edge ergonomic design and fits perfectly in the hand. Moreover, this clipper is particularly small and lightweight. Professionals can thus work effortlessly - whether for grooming, veterinary applications or dog, horse and cow styling. Noise: 63 dB. **Speed: 2600/3100 db/min** (available with 2 batteries on demand).

Sku. 154420

1 battery



STYLE MINI CLIPPER



Heiniger's STYLE MINI clipper has a new lithium-ion battery technology that extends its operating time to 120 minutes. Ideal for clipping small animals and veterinary care. It will provide ultra-precise and fine mowing, with a 30 mm precision steel cutting head and an even more powerful motor. Ideal for the final styling of the dog. The adjustable shoe allows a cutting length of 3 to 6 mm. Quiet, low-vibration and cordless, it offers a clipping time of 120 minutes with a battery charge of 90-120 minutes. After use, the mower can be easily cleaned, thanks to its detachable mowing head. The design remains unchanged. Speed: 5500 oscillations / min. Autonomy: approx. 120 min. Charging time: 90-120 min. Battery technology: Lithium-Ion. Cutting length: 0,3 mm. Noise emission LpAm: <60 dB(A). Length: 145 mm. Width: 30 mm. Height: 38 mm. **Weight: 120 g.** 24 months warranty. Made in Switzerland.

Sku. 154700050

Battery Li-Ion



Sku. 154700100

MINI trimming head





ELECTRIC CLIPPERS | Saphir clippers



BATTERY STYLE MIDI TRIMMER





This trimmer is used for the part trimming of the dog and the contours of the dog's head, legs, belly and tail. The continuously adjustable cutting head allows variable **cutting lengths between 0,5 - 2,5 mm**. The package also includes 5 snap-on combs in the most common **cutting lengths 4, 8, 12, 16 and 20 mm**. Furthermore, the supplied cable adapter allows trimming any time on the 230 V mains. Light with low-noise and precise cut, the new Heiniger Style Midi Trimmer glides through the dog's coat with ease. Noise: 63 dB. **Weight: 240 g. Motor speed: 2400 rpm.** Size: 175 x 46 x 50 mm. Operating time: up to 100 minutes.

Sku. 154710	1 battery	
Sku. 154710100	MIDI trimming head	

Saphir clipper heads



Sku. 100282 
Comb 0,2 mm 





Sku. 100283 
Comb 0,25 mm 



Sku. 100284 
Comb 0,5 mm 



Sku. 100285 
Comb 0,8 mm 



Sku. 100286 
Comb 1,2 mm 



Sku. 100287 
Comb 1,5 mm 



Sku. 100288 
Comb 2 mm 



Sku. 100296 
Comb 2,3 mm 



Sku. 100289 
Comb 2,8 mm 



Sku. 100290 
Comb 3,2 mm 



Sku. 100291F 
Comb 3,2 mm 



Sku. 100292 
Comb 6,3 mm 



Sku. 100293F 
Comb 6,3 mm 



Sku. 100294 
Comb 9,5 mm 



Sku. 100295F 
Comb 9,5 mm 

CURVED BLADE SCISSORS

It is used for the finishing of the mane but also to prepare the animals for the shearing (for dirty or matted parts). They also allow the shearing of small areas before a surgical operation. The curved blade avoids pricking or cutting into the animal skin.



Sku. 100338  3 338020 000920

18 cm

Sku. 100340  3 338020 000944

20 cm

COOL SPRAY FOR COMB **UKAL**

Cooling spray for clippers, combs and blades. This product cools, lubricates and cleans. Therefore it improves shearing and keeps the combs sharp. It prevents dirt accumulation, which optimizes the performance of your shears and ensures perfect hygiene. It is also suitable for hair clippers, beards and electric razors. Clean the combs with a brush or a dust remover spray, then apply the cooling spray.



Sku. 100143  3 700393 914911

500 ml 

SHARPENING PASTE

The very fine grain n°1 sharpening paste is suitable for finishing or cutting heads for dog/ rabbit. Sharpening paste n°2 is suitable for all types of combs and counter combs of Heiniger electric clippers or others. For sharpening bovine, ovine or equine combs. 480 g.



Sku. 100121001  3 338020 000364

Fine grain N°1

Sku. 100121002  3 338020 000371

Coarse grain N°2



Go to page 177 to find out more about our range for pets.

VASELINE OIL **UKAL**

The use of oil is needed for proper operation of the clipper.

Sku. 100141  3 338020 000630

100 ml



SPECIAL CLIPPER OIL **Heiniger**

Specially developed non toxic clipper oil increases performance, reduces friction and enhances blade life.

Sku. 100142105  7 613073 009745

100 ml 

Sku. 100142102  7 613073 001282

500 ml 



NOTES



UKAL

—
**VACCINATION
& DRENCHING**

- 97 Demaplast
- 100 Socorex
- 101 NJ Phillips
- 102 Needles

VACCINATION STRATEGY

The link between vaccination strategy and herd size is clearly visible. 80% of farms with more than 100 cows routinely vaccinate in order to ensure good health of the herd without the cost and time taken by other preventative approaches. In smaller herds, vaccination strategies are less homogeneous: 1 out of 2 breeder does not vaccinate, preferring other preventive strategies more easily permitted by herd size.

How to choose the syringe and needle ?

The choice of a syringe (manual, automatic or revolver) depends on the product to be injected, the injection volume, the repetition of gesture or on the urgency of the injection.

The choice of the needle depends on the type of injection (subcutaneous, intramuscular, intravenous) and the product viscosity. There is a sizing convention. For example, a needle 15/10 = 15 mm length / 10 mm in diameter.

- **Subcutaneous injection** : under the skin for slow diffusion due to low blood supply.
- **Intramuscular injection**: in muscle (thigh or neck) for rapid dissemination through the strong blood supply.
- **Intravenous injection**: in the jugular for immediate action. However, please be aware of shocks. You must use this method only in severe cases.

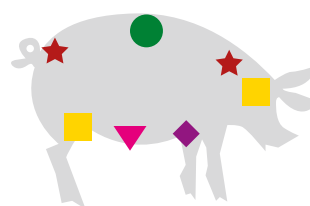
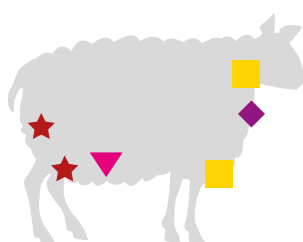
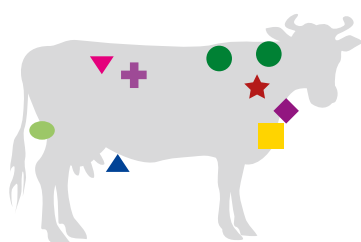

- Subcutaneous
- ★ Intramuscular
- ▼ Intraperitoneal
- ✚ Intraruminal
- ◆ Intravenous
- Intradermical
- Retromammary
- ▲ Intramammary

Examples of application

CATTLE		
Intramuscular 30/15, 30/20, 40/20	Subcutaneous 15/20, 20/20	Intravenous 60/20
SHEEP		
Intramuscular 20/15, 30/15	Subcutaneous 10/10, 15/10	Intravenous 20/15, 30/20
PIGS		
Intramuscular 30/20, 40/15, 40/20, 50/20 10/18	Subcutaneous 10/10, 15/13, 15/10	Intravenous 40/20

HOW TO CHOOSE THE RIGHT NEEDLE?

INTRAMUSCULAR		SUBCUTANEOUS		INTRAVENOUS	
Piglet	10/10 - 15/10	Lamb	20/10	Sheep	30/20 - 40/20
Sow	40/15 - 50/20	Sheep	20/15	Cattle	60/20
Poultry	10/15	Cattle	20/20 - 25/15 - 30/15	For oily product	Diameter 15 or 20
Lamb	15/15				
Sheep	25/20				
Cattle	30/20 - 35/15 - 40/20				



Veterinary quality. DEMAPLAST offers a wide range of products for vaccination (manual, semiautomatic or automatic syringes) and for the drenching (dosing syringes, drenchers). The products are manufactured in Europe. They are known for their quality and their very good value for money.

— PLEXI SYRINGE



Economical syringes. Multi-purpose. Can be boiled or cold sterilized. **Plastic piston, cover and handle.** Wash thoroughly after use. Rinse thoroughly with clean water. Lubricate with vaseline oil Sku. 110039. Replace washers regularly. Do not autoclave. With LUER LOCK fitting.

Sku. 110004005	5 ml tip luer lock Sku. washer: 9DE005		
Sku. 110004010	10 ml tip luer lock Sku. washer: 9DE010		
Sku. 110004020	20 ml tip luer lock Sku. washer: 9DE020		
Sku. 110004030	30 ml tip luer lock Sku. washer: 9DE030		
Sku. 110004050	50 ml tip luer lock Sku. washer: 9DE050		
Sku. 110004100	100 ml tip luer loc Sku. washer: 9DE100		



LUER LOCK

— METAL SYRINGE



Handle and cover made in metal. Can be boiled or sterilized at high temperature. Wash thoroughly after use. Rinse in clear water. Lubricate with vaseline oil Sku. 110039. Replace washers regularly. With LUER LOCK fitting.

Sku. 110001005	5 ml - Sku. washer : 9DE005 Limited stock		
Sku. 110001010	10 ml - Sku. washer : 9DE010		
Sku. 110001020	20 ml - Sku. washer : 9DE020		
Sku. 110001030	30 ml - Sku. washer : 9DE030		
Sku. 110001050	50 ml - Sku. washer : 9DE050		



LUER LOCK



PRIMA AUTOMATIC SYRINGE



Professional instrument. Automatic syringe. Body made of nylon and the barrel a specific polymer. Ergonomic handle for a better grip. Precise and reliable dosing thanks to the valve. Supplied with spare part kit.

This model is supplied with vial holder.

Sku. 110040202 

2 ml vial holder 

Sku. 110040205 

5 ml vial holder 

This model is supplied with feeding tube (not pictured).

Sku. 110040101 

1 ml feeding tube 

Sku. 110040102 

2 ml feeding tube 

Sku. 110040105 

5 ml feeding tube 

Sku. 110040110 

10 ml feeding tube 

+ PRODUCTS

- High quality
- Effortless, high throughput vaccination
- From small to large animals
- Suitable for most liquids and suspensions
- Operate under any climatic conditions
- Easy disassembly and maintenance
- All components are treated against corrosion



DRENCHING GUN



Very robust ABS grip and ergonomic handle. Transparent acetate barrel. Resistant to chemical attack. Dose adjustment by screw. Comes with a 125 mm (9AL125) cannula for 35 ml and 70 ml pistols. Original design. Made in Europe.

Sku. 107035 

In acetate - 35 ml 

Sku. 107070 

In acetate - 70 ml 

Sku. 107035A 

Automatic dosing gun 35 ml 

Sku. 107070A 

Automatic dosing gun 70 ml 



DRENCHING GUN



Very robust and ergonomic ABS grip. Transparent acetate or polypropylene barrel. Resistant to chemical stress. Calibration through distal screw. Comes with a 200 mm (9AL200) cannula for 200 ml and 300 ml pistol. Made in Europe.

Sku. 107200 

Acetate barrel - 200 ml 

Sku. 107200S 

Drenching gun polypropylene cylinder 200 ml 

Sku. 107300 

Polypropylene transparent barrel 300 ml 

Sku. 107805 

Service kit for drenching gun - 300 ml 



Discover the VINK head lift on page 26



AUTOMATIC DRENCHING GUN BRAVO + HOSE



The valve and the tank are resistant to chemical attack. Dosage adjustment using the wheel behind the barrel. Ergonomic handle. Supplied with nozzle, suction hose, Luer Lock and spare parts (washers). Can be used with tank Sku. 107900 (sold separately).

Sku. 107430 3 338020 055197

30 ml

Sku. 107460 3 338020 055203

60 ml

METAL DRENCHING SYRINGE



Metal piston and handle. Plexi transparent barrel. Complete, delivered with 250 mm cannula (9AL 250).

Sku. 107630 3 338020 002887

300 ml

Sku. 107645 3 700393 927836

450 ml

PLEXI DRENCHING SYRINGE



Drenching syringe. Cellulose acetate. Very resistant to shock and to chemical stress. Delivered with cannula.

Sku. 107755 3 338020 002979

250 ml

CANNULA FOR SYRINGES



To be used with metal and plexi DEMAPLAST syringes.

Sku. 107760 3 338020 002993

LUER LOCK Length: 120 mm

Sku. 107762 3 338020 003013

Male screw Length: 120 mm



LUER LOCK

MALE

TANK SET FOR AUTOMATICS GUNS



1 plastic backpack with 3 liter capacity.

Sku. 107900 3 L 3 338020 053933



INTRAVENOUS SET



Allows perfusion for intravenous treatment. Rehydration fluid, minerals, glucose, etc.

Sku. 110600 Silicone 3 338020 066988

Sku. 110601 PVC 3 700393 971631





SOCOREX is a Swiss brand. They manufacture a wide variety of high precision instruments used for reliably measuring, dosing, transferring, dispensing and injecting liquids in a large number of applications. Each precision instrument bears its own serial number and passes a strict performance control attested by an individual QC certificate. Discover the automatic syringes from SOCOREX.



AUTOMATIC SYRINGE WITH VIAL HOLDER



Most commonly used, the automatic vial feeding syringe is perfectly adapted for injecting aqueous, oily, viscous or heavy iron solutions as well as a variety of suspensions. Enables tight fitting of any 20 mm neck diameter vaccine vial. (needle not included).

Sku. 110050011/5	0,5 ml	7 630002 700641
Sku. 110050011	1 ml	7 630002 700658
Sku. 110050012	2 ml	7 630002 700665
Sku. 110050015	5 ml	7 630002 700672
Sku. 110050020	10 ml	7 630002 700689

AUTOMATIC SYRINGE WITH FEEDING TUBE



Automatic Syringe supplied with aspiration and vent cannulas, sinker and silicone tubing (1 metre), spare part kit and operating instructions (needle not included).

Sku. 110050001/5	0,5 ml	7 630002 700702
Sku. 110050001	1 ml	7 630002 700719
Sku. 110050002	2 ml	7 630002 700726
Sku. 110050005	5 ml	7 630002 700733
Sku. 110050010	10 ml	7 630002 700740



PLASTIC DRENCHING GUN

Metal cannula. Plastic body. Ideal for sheep. Lightweight. Easy to clean.

Sku. 107830



25 ml



SEMI AUTOMATIC PLASTIC SYRINGE

Comfortable handle. Easy choice of 5 fixed dose settings. Ergonomic fingertip action reduces hand strain.

Sku. 110010050



50 ml

Sku. 110010025



25 ml



METAL ORAL DRENCHER

Light weight, well balanced, robust design. Easy access to piston and valves for servicing. Simple dose adjustment system. High-flow, blockage resistant valves. Highly chemical resistant cylinder with moulded graduations. Dosage from 1 to 20 ml. Delivered with a sheep cannula. Service kits available.

Sku. 107820020



20 ml

Sku. 107815020



20 ml with backpack
2,5L



SEMI AUTOMATIC METAL SYRINGE

Comfortable handle. Administers a variety of vaccines. Easy to clean and maintain. Fixed settings for ease and speed of use.

Sku. 110013050



50 ml

Sku. 110013025



25 ml



Accessories

VASELINE OIL UKAL

Lubrication of materials and various equipments. Jelly oil is essential for the operation of the syringes and the clipper. Non toxic. Doesn't irritate the skin.

Sku. 110039



50 ml



Sku. 100141



100 ml



WEIGHTBAND KAMER

For an approximate evaluation of the weight in kg of living animals. Not allowed for commercial transactions. Customisation available on request.

Sku. 129040



VACCINATION | Needles



TRIPLE EDGE NEEDLES

Luer Lock hub. Triple edge sharpening ensures better penetration.

Sku. 110180		L 10 mm Ø 8. Box of 12
Sku. 110190		L 10 mm Ø 10. Box of 12
Sku. 110190008		L 8 mm Ø 10. Box of 12
Sku. 110200		L 15 mm Ø 10. Box of 12
Sku. 110201		L 20 mm Ø 10. Box of 12 Limited stock
Sku. 110201030		L 30 mm Ø 10 Box of 12 Limited stock
Sku. 110202040		L 40 mm Ø 12. Box of 12
Sku. 110205		L 15 mm Ø 13. Box of 12
Sku. 110205013		L 13 mm Ø 13. Box of 12
Sku. 110207		L 15 mm Ø 15. Box of 12
Sku. 110207010		L 10 mm Ø 15. Box of 12
Sku. 110210		L 20 mm Ø 13. Box of 12

Sku. 110215		L 20 mm Ø 15. Box of 12
Sku. 110216		L 25 mm Ø 15. Box of 12
Sku. 110218		L 25 mm Ø 20. Box of 12
Sku. 110220		L 30 mm Ø 13. Box of 12
Sku. 110221		L 30 mm Ø 15. Box of 12
Sku. 110225		L 40 mm Ø 15. Box of 12
Sku. 110230		L 50 mm Ø 15. Box of 12
Sku. 110247		L 15 mm Ø 20. Box of 12
Sku. 110250		L 20 mm Ø 20. Box of 12
Sku. 110255		L 30 mm Ø 20. Box of 12
Sku. 110260		L 40 mm Ø 20. Box of 12
Sku. 110265		L 50 mm Ø 20. Box of 12



DELVO VETERINARY NEEDLES

High quality veterinary needles. Triple bevel sharpening. LUER LOCK hub.

Sku. 110300		L 10 mm Ø 10. Box of 12
Sku. 110301		L 15 mm Ø 10. Box of 12
Sku. 110305		L 10 mm Ø 15. Box of 12
Sku. 110307		L 15 mm Ø 15. Box of 12
Sku. 110315		L 20 mm Ø 15. Box of 12
Sku. 110321		L 30 mm Ø 15. Box of 12
Sku. 110347		L 15 mm Ø 20. Box of 12
Sku. 110350		L 20 mm Ø 20 Box of 12
Sku. 110355		L 30 mm Ø 20 Box of 12
Sku. 110360		L 40 mm Ø 20. Box of 12
Sku. 110365		L 50 mm Ø 20. Box of 12





UKAL

—
**FARM
AND STABLE
EQUIPMENTS**

- 104 **Hygiene**
- 106 **Detergent**
- 107 **Drinkers**
- 109 **Feeders**
- 111 **Baling twine and hay racks**
- 113 **Cleaning**
- 115 **Shovels**
- 117 **Shafts**
- 118 **Scales**
- 119 **Thermometers**
- 120 **Hooks**



VISITOR'S KIT

Practical, complete and compact.
The visitor kit includes:

- a gown,
- overboots,
- mask and a hairnet.

Ideal for all livestock farms visits.

For single use only.

Sku. 101115900	Sold singly	3 338020 054930	
Sku. 101115910	Visitor kit without mask	3 700393 916830	
Sku. 129117	Surgical masks by 50 Limited stock	3 701217 300118	



BLUE DISPOSABLE OVERALLS

Zip fastening. With hood but without overshoes. Blue. **For single use only.**

Sku. 101115915	3 700393 961960	
XL		



DISPOSABLE OVERBOOTS

Polyethylene overboots with elastic for a better hold. Supplied in a bag of 25 pairs.
For single use only.

Sku. 1011140	5 703188 220103	
By 25		



BLUE HAIRNET

Blue mob cap in polypropylene. Latex free elastic. Diameter 48 cm. **For single use only.**

Sku. 101115800	3 700393 963179	
By 100		



DISPOSABLE OVERALLS

Zip fastening. With hood but without overshoes. **For single use only.**

Sku. 101115912V	3 338020 066193	
L		
Sku. 101115913V	3 221170 003579	
XL		
Sku. 101115914V	3 338020 077830	
XXL		



NITRILE GLOVES

Nitrile gloves are soft and ideal for the animal care. Available in different sizes. Rolled edges. Ambidextrous. Powder free. No Latex. Compliant with 93/42/EEC and 89/686/EEC. Conforms to EN 455, EN 420 and EN 374.

Sku. 101115301	3 700636 910175	
M		
Sku. 101115302	3 700636 910168	
L		
Sku. 101115303	3 700636 910199	
XL		

CALVING GOWN UKAL

Cotton coated with PU. Resistant to common cleaning agent. Available in navy blue. Used in the food processing industry. Back fixation with a stainless steel hook and elastic. Diameter: 13 mm. Thickness: 500 microns.

Sku. 101121010



M



Sku. 101121011



L



DAIRY APRON UKAL

Polyurethane. Adjustable neck strap. Back closing by stainless steel hook and elastic. Can be used with liquid up to 60° C. Thickness 500 microns. 380 gr/m². Dimensions: 90 x 115 cm.

Sku. 124080010



Blue



DAIRY APRON UKAL

Very appreciated by the breeder! Resistant! With neck strap, closing stainless steel hook in the back with elastic. Can be used with liquid up to 50° C. Thickness : 350 microns. 475 gr/m². Dimensions 90 x 115 cm.

Sku. 124080001



White



DAIRY SLEEVES

Blue polyurethane dairy sleeves with wrist and forearm tightening. Neoprene at the wrists and elastic at the biceps. Resistant to common cleaning products.

Sku. 124086002



By 2 / 40 cm



NEOPRENE PROTECTION SLEEVES

Waterproof protective dairy sleeves. They keep your forearms warm, dry and also protected. They are made from quality 3 mm neoprene. Simply pull them on over your wrist and take them off when you want! Can be used in farms, dairy farming and also gardening. In pairs.

Sku. 124087100



M



Sku. 124087200



L

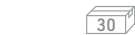

Sku. 124087300



XL



Sku. 124087400



XXL



SEPTICARE HOOFMAT



Small and top class model. The whole hoof treated due to the thickness of the mat. Capacity: 21 liters.

Sku. 113100002



Dimensions : 90 x 60 x 4 cm



BOOT CLEANER KAMER

In order to ensure hygienic working conditions, you must start with caring for your boots. Cleans effortlessly. Stainless steel. Automatic. The brush is triggered as soon as the boot is put on. Delivered assembled.

Sku. 132910005



5 brushes



Professional detergent



ECOLOGICAL PROFESSIONAL DETERGENT



99,5% of natural ingredients. Detergent containing traditional Marseilles soap. Sulphatefree detergent made with Marseilles soap flakes and 100 % plant oils. Highly concentrated, it is suitable for all kinds of fabrics for machine and hand washing at 30° C. Hypoallergenic, formulated without fragrance to protect sensitive skin. For professional use. Organic product certified by ECOCERT.

Sku. 850005	5 L	3 ¹ 700393 901027	
Sku. 850010	10 L	3 ¹ 700393 926631	



DISCOVER OUR VIDEO

Non-contractual visual



IDEAL DRINKING BOWL MODEL 61

SUEVIA

Enameled cast bowl made of cast iron. Smoothly running pipe valve for a calm water flow. 1/2" water supply from the top or the bottom. For pipe or wall mounting. 4-hole fixation. Approximate water flow quantity of 6 l/min (at 5 bar water pressure).

Sku. 119160



4 025338 000245

Cast iron



DRINKING BOWL MODEL 10P

SUEVIA

High quality plastic drinking bowl. Smoothly running pipe valve for a calm water flow. 1/2" water supply from the top. For pipe or wall mounting. 2-hole fixation. Approximate water flow quantity of 6,5 l/min (at 5 bar water pressure).

Sku. 119170



4 025338 000085

Plastic



FLOATER DRINKING BOWL

Solid plastic bowl and cover. With resistant float valve. 1/2" water supply from on the side. Easy adjustment of water level. Approximate water flow quantity of 10 l/min (at 5 bar water flow).

Sku. 119165



4 014803 346391

Plastic

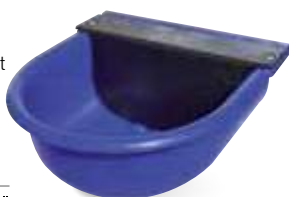

DRINKING BOWL WITH PIPE VALVE

Double powder coated bowl made of cast iron. Smoothly running pipe valve for a calm water flow. 1/2" water supply from the top or the bottom. For pipe and wall mounting. 4-hole fixation. Approximate water flow quantity of 12 l/min (at 5 bar water flow).

Sku. 119180



4 014803 301888

Cast iron



FLOATER DRINKING BOWL XL

Solid plastic bowl and cover. With resistant float valve. 1/2" water supply from on the side. Easy adjustment of water level. Approximate water flow quantity of 10 l/min (at 5 bar water flow).

Sku. 119185



4 014803 343253

Cast iron 2,5 L



DRINKING BOWL WITH PRESSURE TONGUE

Double powder coated bowl made of cast iron. Exchangeable brass valve. 1/2" water supply from the top or the bottom. For pipe and wall mounting. 4-hole fixation. Approximate water flow quantity of 8-10 l (at 5 bar water flow).

Sku. 119190



4 014803 312006

Cast iron - stainless steel tongue



Sku. 119195



4 014803 312013

Cast iron



FARM AND STABLE EQUIPMENTS | Drinkers



LIGHT GREEN EPOXY BUCKET

Galvanized + epoxy coating. With spout. Light green.

Sku. 120003013



12 L

Limited stock



ALUMINIUM BUCKET

Material : Aluminium. With spout.

Sku. 120003012



12 L



GREEN PLASTIC BUCKET

Plastic. Extremely durable and shatterproof due to the high wall thickness. Extra stable handle for everyday use. With inner scal. **Made in Europe.**

Sku. 122016

7 L



Sku. 122020

12 L



Sku. 122021

17 L



**EQUIP YOUR WATERING TROUGHS
WITH OUR HOTLINE MEADOW PUMP.**
An energy-saving solution!



→Go on page 336 to discover our range



UNIVERSAL MANGER WITH GRASP

Made of very high impact resistant polypropylene with rounded edges. With carrying handle 13 liters capacity. Dimension: width x height x depth = 36,5 x 38 x 28 cm. **Made in Europe.**

Sku. 122205008	Green	4 014803 444837
Sku. 122205002	Black	4 014803 444844



FEED BUCKET WITHOUT HANDLE

Plastic with steel attaching hools perfectly adapted for boxes doors. Very resistant. 14 L[≈]. Dimensions : 38,1 x 30,5 x 25,4 cm. **Made in Europe.**

Sku. 122202002	Black	4 014803 440273
Sku. 122202006	Blue	4 014803 343222
Sku. 122202008	Green	3 338020 053834



PORTABLE MANGER

Made of very high impact resistant polypropylene with rounded edges. With mounting brackets and carrying handle **13,5 liters capacity**. Dimension: width x height x depth = 36 x 37 x 31 cm. **Made in Europe.**

Sku. 122203002	Black	4 014803 444806
Sku. 122203006	Turquoise	4 014803 445933
Sku. 122203008	Green	4 014803 445919
Sku. 122203009	Kaki	4 014803 444790
Sku. 122203020	Purple	4 014803 445926



MANGER WITH HOOK AND HANDLE

Very solid. Perfect for transport. **Approx. 14 liters capacity**. Several colors are available.

Sku. 122206002	4 014803 440327	Sku. 122206008	4 014803 440280
Black		Green	
Sku. 122206003	4 014803 440310	Sku. 122206020	4 014803 441041
Red		Purple	
Sku. 122206006	4 014803 343239	Sku. 122206022	4 014803 441065
Blue		Turquoise	
Sku. 122206007	4 014803 440297		
Light green			





UNIVERSAL MANGER

Made of very high impact resistant polypropylene with rounded edges. **12 liters capacity.** With inner scale 41 x 34 x 35 cm. **Made in Europe.**

Sku. 122207002 

Black

Sku. 122207008 

Green



FOAL MANGER

With adjustable bars. Made of very high impact resistant polypropylene with rounded edges. **8,5 liters capacity.** Thanks to the adjustable bars only the foal can take up the feed. Easy, quick and flexible adjustment to suit growing animals. Dimension: width x height x depth = 35 x 22,5 x 29 cm. **Made in Europe.**

Sku. 122209002 

Black

Sku. 122209008 

Green



NEW

28 L FLEXI-TUB

Flexible tubs ideal for everyday work in small stables (clearing out stalls, distributing water, grain or hay). Not only sturdy and strong but also flexible and very light. **Capacity: 28 litres.**

Sku. 130E711003002 

Black

Sku. 130E711003003 

Red

Sku. 130E711003006 

Blue

Sku. 130E711003008 

Green

Sku. 130E711003013 

Pink

Sku. 130E711003015 

Purple



CALF AND SHEEP FEEDER

Made of very high impact resistant polypropylene with rounded edges. **8,5 liters capacity.** Foal manger insert also fits with this feeder. Dimension: width x height x depth = 35 x 22,5 x 28 cm. **Made in Europe.**

Sku. 122208002 

Black

Sku. 122208008 

Green



NEW

15 L FLEXI-TUB

Flexible tubs ideal for everyday work in small stables (clearing out stalls, distributing water, grain or hay). Not only sturdy and strong but also flexible and very light. **Capacity: 15 litres.**

Sku. 130E711002002 

Black

Sku. 130E711002003 

Red

Sku. 130E711002006 

Blue

Sku. 130E711002008 

Green

Sku. 130E711002013 

Pink

Sku. 130E711002015 

Purple



BALING TWINE

Polyethylene baling twine, with loops.

Sku. 130E306823002



Black



BALING TWINE

Polypropylene, with loops.

Sku. 130E306760



Assorted colors



Hay racks

HEAVY DUTY CORNER HAY RACK

Depth: 53 cm. Grill type: 12 mm diameters bars.

Sku. 119400002



83 x 53 x 83 cm



HAY RACK LARGE MODEL

Made from zinc-plated steel. Strong, sturdy model. Available in two sizes.

Sku. 119400003



Big model
70 x 70 x 45 cm

Sku. 119400004



Little model
50 x 35 x 21 cm

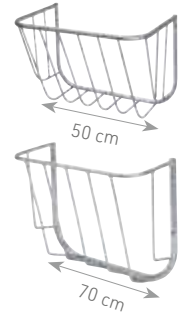

Salt lick holders

SALT LICK HOLDER

The plastic salt lick holder helps to avoid animal dung waste and pollution of mineral supplements. Helps to control the animal salt consumption. For round and square lickstones up to 10 kg. Solid design, plastic. Anti-bite edge. UV-resistant. **Made in Europe.**

Sku. 119300002

Black



Sku. 119300004

Brown
Limited stock



Sku. 119300006

Blue
Limited stock



Sku. 119300008

Green



Sku. 119300021

Purple
Limited stock



SALT LICK HOLDER

For 2kg lickstones. Solid design. Foodsafe. Anti-bite edge. UV-resistant.

Sku. 119300204



Brown
Limited stock



REMOVABLE BRIDLE BRACKETS

For outdoor or indoor use. Made of sturdy plastic-coated metal, with one or two fixed bridle brackets and one multi-purpose hook.

Sku. 130E704226002



Black



VINYL COATED SADDLE RACK

Standard type saddle rack. Ideal for your tack room.

Sku. 130E704220002



Black



BRIDLE BRACKET

Full headpiece support. Metal covered with plastic.

Sku. 130E704204002



Black





JUMP CUPS HOLDER

Made of extra-strong ABS plastic with notches for jump cups every 5 cm. Affixes to a wooden post with screws Interlocks with one or several additional holders to increase total height.

Sku. 130E704601005  3 338025 428231

Jump cup

Sku. 130E704600005  3 338025 428224

Jump cups holder



GRIP FOLDING STOOL



Stool with anti-slip rubber pimples. Easy to carry thanks to its integrated handle, and can be easily stored away behind a cabinet or inside your locker. Features anti-slip rubber legs. Can hold weights of up to 100kg. Dimensions: L 28,5 x W 21,5 x H 39 cm. Compliant with EN 14183:2003 safety standards.

Sku. 130E930251  3 338025 494335

Grey





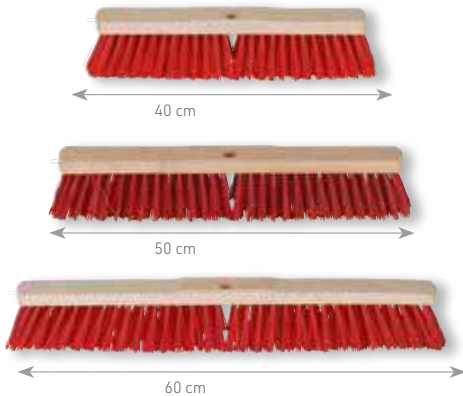
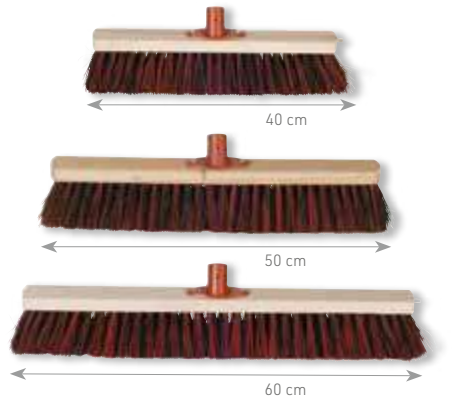
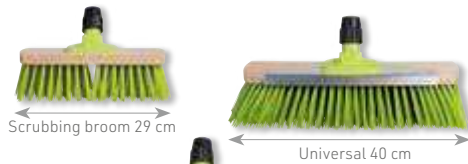

Brooms





GREEN RANGE BROOMS

A high quality range. Without shaft. Suitable shafts: 129007002 and 129007003.

Sku. 129300100 Scrubbing broom 29 cm  4 250560 516602 

Sku. 129300120 Universal - 40 cm  4 250560 500298 

Sku. 129300140 Large - 40 cm  4 250560 514783 

FARMERS BROOM

Plastic shaft holder (24 mm). Dustbinding, moisture resistant and very robust due to Arenga / Elaston bristles. Ideal for high load. Without shaft. Suitable shafts: 129007002 & 129007003.

Sku. 129300160 40 cm  4 250560 509598 

Sku. 129300180 50 cm  4 250560 509635 

Sku. 129300200 60 cm  4 250560 509666 

HALL BROOM

With saddle wood and shaft hole (24 mm). With red and moisture resistant PVC bristles. Without shaft. Suitable shafts: 129007002 and 129007003.

Sku. 129300220 40 cm  4 250560 509413 

Sku. 129300240 50 cm  4 250560 509451 

Sku. 129300260 60 cm  4 250560 509482 

Forks

SHAVING FORK "ORIGINAL SWEDISH"

Extrem durable, flexible, virtually unbreakable plastic with a high rate of polycarbonate. Extra angular prongs for easy gathering of shavings and manure. Without shaft. 18 prongs. Fork width approx. 40 cm.

Sku. 129480102	Grey	4		
Sku. 129480106	Blue	4		
Sku. 129480108	Green	4		
Sku. 129480120	Purple	4		



SHAFT FOR SHAVING FORK "ORIGINAL SWEDISH"

Incl. bolts. Approx. Ø 26 mm. 115 cm long. Aluminium with plastic handle.

Sku. 129480112	Grey	4		
Sku. 129480116	Blue	4		
Sku. 129480118	Green	4		
Sku. 129480121	Purple	4		



ALUMINUM HANDLE FOR FORK

Length 123 cm. Without shaft. Suitable shaft: 129480201.

Sku. 129480200		
Polycarbonate		



SHAVING FORK WITH EXTRA HIGH SIDE PARTS

No lateral falling down of muck. Without shaft. Suitable shaft: 129480201. Solid plastic. 17 prongs. Prong length approx. 35 cm. Fork width approx. 40 cm.

Sku. 129480202		
Polycarbonate		



ALUMINUM HANDLE FOR FORK

Length 123 cm. For sku. 129480200 and 129480202.

Sku. 129480201	Aluminium	4		
-----------------------	-----------	---	--	--



MANURE FORK, 4 TEETH

Fork 4 teeth ideal for manure. With ash handle 135 cm. Height of the teeth: 22 cm. Width of the teeth: 31 cm. Anti-corrosion protection, the fork is laquered.

Sku. 129480600	31 cm silver lacquering	4		
Sku. 129480300	31 cm gold lacquering	4		



FARM AND STABLE EQUIPMENTS | Cleaning



HAY FORK, 3 TEETH

Hay fork with 3 teeth and ash handle 135 cm long. Anti-corrosion protection, the fork is laquered. Height and width of the fork head: 30 cm.

Sku. 129480400	30 cm gold lacquering	4	014803 310668	5
Sku. 129480500	26 cm silver lacquering	4	014803 310651	5

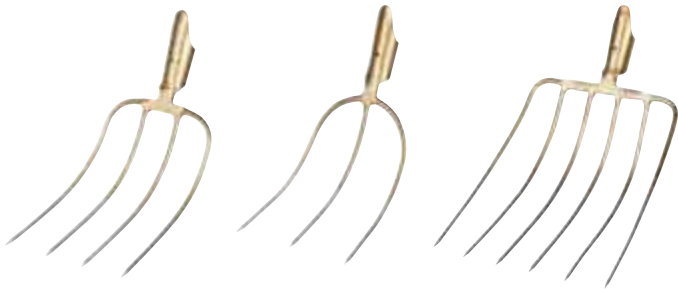

FORKS WITH SPRING SOCKET

Without shaft. 1/2 gold and 1/2 silver lacquered. Suitable shafts: 129007008 and 129007010.

Sku. 129480510	26 x 20 cm 3 teeth	4	014803 310026	5
Sku. 129480610	26 x 20 cm 4 teeth	4	014803 310002	5
Sku. 129480620	26 x 20 cm 6 teeth	4	014803 310453	5

Hay rake



HAY RAKE

Solid high quality plastic for a long durability. Approx. 64 cm wide. Delivery without shafts. Suitable shaft: 129007003.

Sku. 129481	5	411069 161000	10
--------------------	---	---------------	----

16 teeth

NEW

EXTRA-POWERFUL UNIVERSAL FARM DETERGENT



Septicare extra-powerful universal detergent for in-depth cleaning and degreasing of farms, livestock equipment and agricultural machinery and vehicles (tractors, livestock transport vehicles, ect.). Can also be used to clean your milking parlours and processing facilities on the farm. Highly effective in eliminating oil and grease. High performance detergent. Concentrated formula, effective even in small doses. Dilutes easily in hot or cold water. Made with Landes pine derivatives.
Concentrated formula.

Sku. 000602100	5 l	3	700393 926488	4
-----------------------	-----	---	---------------	---



Cleaning product

CRESYL BACTERICIDAL DISINFECTANT FUNGICIDE



CRESYL is an effective disinfectant based on phenolic oil and cresol oil. The product is ideal to clean and for disinfecting cattle barns, rabbit hutches, hen houses and all transport equipment. The dilution rates is 3% (3 liters of Cresyl for 100 L of water).

Sku. 000601001	3	172358 322206	12
1 L			
Sku. 000601005	3	172358 322213	4
1,5 L			

Sprayers



MULTI-USE SPRAYER

KAMER

Adjustable jet with brass nozzle. Anatomical shape, shockproof.

Sku. 123400	3	338020 085163
--------------------	---	---------------

By unit



SPRAYER WITH QUICK CONNECT

Gilmour

Ideal for spraying hot or cold water. Metal head insert for maximum resistance to hot water. Male hose threaded front for attaching accessories. Metal valve stem and adjusting nut. Rubber head guard protects threads. Flow control adjusts water flow. Hold-open clip for continuous spraying. Insulated handle.

Sku. 123600	0	034411 057216	24
--------------------	---	---------------	----

By unit

Scrapers

STRAIGHT SCRAPER

Ideal after washing the floor. Bracket material : Zinc plated. Delivered with 2 rubbers (129006).

Sku. 129005  3 338020 038343

60 cm

Sku. 129006  3 338020 039456

Rubber for straight scraper

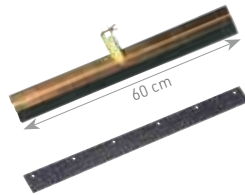

CURVED DUNG SCRAPERS

Rubber band. The rubber band and the handle brace are replaceable. Stick not included. Zinc plated. Spare rubber 55 cm (sku. 129004) and 75 cm (sku. 129002).

Sku. 129001  3 338020 035021

75 cm

Sku. 129003  3 338020 036714

55 cm

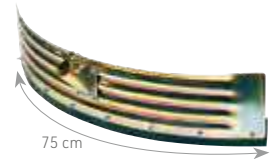

SMP DUNG SCRAPER

Ejection squeegee, reinforced model. Use for the maintenance of waiting areas, curtains. Galvanized. Delivered without sleeve.

Sku. 129008  3 338020 077106

75 cm

Sku. 129009  3 338020 077120

55 cm

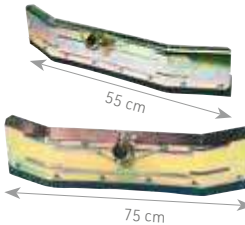

PULL SCRAPER

Green, lacquered steel. Useful for keeping holding areas and sawdust covered grounds clean. Stick not included.

Sku. 129009100  3 338020 085682

35 cm



Squeegee

STAINLESS STEEL FLOOR SQUEEGEE

Removes all chaff and dust without lifting. The soil dries out faster. Lightweight and easy to wash.

Sku. 129271 44 cm  5 410616 144411  40

Sku. 129272 60 cm  5 410616 145913  12

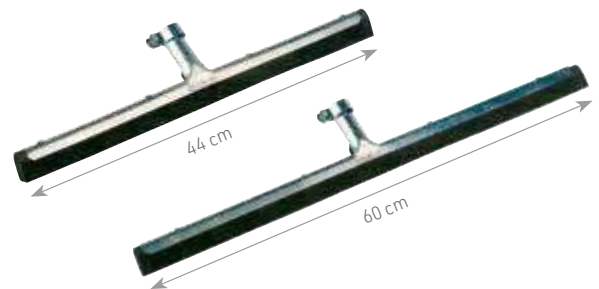

Shovels

FLAT ALUMINIUM SCOOP

KAMER

Flat feeding scoop in aluminium. Sustainable quality.

Sku. 129010001 1 kg  4 014803 301369  50

Sku. 129010002 1,6 kg  4 014803 301376  40

Sku. 129010005 2,5 kg  3 700393 923906  20











ROUND ALUMINIUM SCOOP

KAMER

Thanks to this high-quality aluminum round loading shovel, you can easily feed your animals. Its aluminum construction offers an incomparable resistance as well as a lightness that you will appreciate!

Sku. 129010003	0,750 kg	4  014803 301895	 50
Sku. 129010004	1,6 kg	4  014803 301901	 18
Sku. 129010006	2,5 kg	3  700393 964947	 40



SCOOP IN GALVANIZED SHEET METAL

KAMER

Plastic sleeve.

Sku. 129010100  338020 011889

Small model 1,5 L

Sku. 129010150  338020 011896

Middle model 2 L



PLASTIC SHOVEL

Plastic feeding shovel. Easy to use and to clean. Non toxic. Grey.



Sku. 129011002  4 014803 312464

1,5 kg







PLASTIC FEED SCOOP

Small feed plastic scoop. Non-toxic. White.

Sku. 129012	1 L	3  338020 053872
Sku. 129012015	1.5 L	3  338020 059157
Sku. 129012020	2 L	3  338020 059164

ALUMINIUM SHOVEL

Material thickness: 2 mm. Suitable shafts 129007004, 129007006 and 129007007.

Sku. 129015400	With handle 38 x 38 cm	4  014803 310538	 5
Sku. 129015500	Without handle 34 x 33 cm	4  014803 311726	 5



ALUMINIUM GRAINS SHOVEL

KAMER

Ideal for grain. Supplied with handle.

Sku. 129015  338020 000074

Handle 1,30 m



FEEDING CUP

 **horizont**



Easy measuring of feed quantity with inner scale. Food safe polypropylene. Shatter-proof premium plastic. Perfect for bagged feed - the short handle avoids cracks. Red.

Sku. 129016  4 014803 347152



1,5 L





SHAFT FOR BROOM



Sku. 129007002 1400 x 24 mm 4  

SHAFT FOR SCRAPERS



Sku. 129007003 1500 x 28 mm 4  

SHAFT FOR SHOVEL



Sku. 129007004 1300 x 41 mm 4  

Sku. 129007005 1300 x 32 mm 4  



SHAFT WITH T-HANDLE

Sku. 129007006 1100 x 41 mm 4  



SHAFT WITH T HANDLE

Sku. 129007007 1300 x 41 mm 4  

SHAFT

Sku. 129007008 1350 x 36 mm 4  



SHAFT WITH METAL NOSE

Sku. 129007009 1350 x 36 mm 4  



SHAFT CURVED WITH T-HANDLE

Sku. 129007010 1350 x 36 mm 4  

SHAFT FOR SQUEEGEE

Sku. 129007011 1200 x 36 mm 4  

SHAFT FOR MUCK AND SLURRY PUSHER

Sku. 129007012 1700 x 32 mm 4  

WOODEN SHAFT

Sku. 129007013 1800 x 40 mm 4  



Scale



CATTLE COUNTER KAMER

For an evaluation of the number of living animals. 4 rows. Metal. Manual.

Sku. 129041 

Metal



FIRST ELECTRONIC SCALE KAMER

Not allowed for commercial transactions. This Kamer First electronic load cell is ideal for making a precise weighing up to 30 % 25 kg. Its digital screen, you will get an easy & amp. Read and you will be sure never to make any mistakes. This electronics is a remarkable precision, Its graduation of 10 g. The weight can be measured in kg or in pounds. This electronic load cell has a very handy ergonomic handhold that allows you to hold it firmly when weighing.

Sku. 129051025 

25 kg graduation: 20 g 

Sku. 129051050 

50 kg graduation: 20 g 

Sku. 129051100 

100 kg graduation: 20 g 

Sku. 129051150 

150 kg graduation: 20 g 

150 KG



KITCHEN SCALE KAMER

Kitchen scale, **not allowed for commercial transactions.** High precision sensor system- Large LCD backlight display. Different weighing units (kg, lb, b / oz) - External calibrationtare function- Capacity: 150 kg. Low battery and overload indication- Remote display (on the wall, desk ...). Allows weighing large packages without hiding the display. Stainless steel platform. Power: 1,5 V x 4 AA battery or 110 V adapter (included). Does not stop automatically. Built-in clock (press the ON / TIME button to see the time). Minimum weight: 300 g. Graduation by 50 g.

Sku. 129052150 

150 kg 



200 KG



DIGITAL CRANE SCALE KAMER

Not allowed for commercial transactions. New model with more advanced electronics. Versatile, reliable, accurate and easy to use. New large LCD display for better visibility (visual distance over 10 m). Removable hook.

Sku. 129051200 

200 kg 

300 KG



DIGITAL CRANE SCALE KAMER

Peson KAMER Digital display Color Assorted Prohibited for commercial transactions. The new KAMER crane scale is robust, precise and highly reliable. The large and bright led display allows easy reading. Shockproof and vibration resistant construction makes the weighting fast and stable. Raising, weighting, and registering data are done at once. Your best partner for construction, agriculture, warehouse, factory, dock or storage. Not for commercial use. The 1000 kg scale is delivered with a **remote control.**

Sku. 129053030 

300 kg graduation: 100 g 

129053100 

1000 kg graduation: 500 g

1T



STANDARD SPRING SCALES KAMER

Not allowed for commercial transactions.

Sku. 129055010 

Graduation precision: 50 g/kilos number: 10 kg 

Sku. 129055025 

Graduation precision: 100 g/kilos number: 25 kg 

Sku. 129055050 

Graduation precision: 250 g/kilos number: 50 kg 

Sku. 129055100 

Graduation precision: 500 g/kilos number: 100 kg 

Sku. 129055250 

Graduation precision: 1000 g/kilos number: 250 kg 



NEW

RAIN GAUGE

The rain gauge must be placed in an open area and inserted in the ground vertically.

Sku. 129030100



Rain gauge



NEW

WALL THERMOMETER

Wall plastic thermometer. Mercury free. No batteries are required.

Sku. 129023100



18 cm



Sku. 129025003



28 cm



Sku. 129022100



40 cm

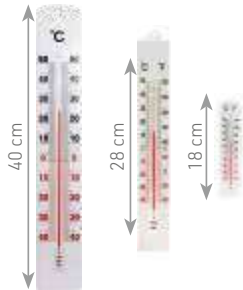

MAXI MINI DIGITAL THERMOMETER DUAL DISPLAY

Instructions The MAX-MIN thermometer simply records the maximum and minimum temperatures obtained during a period. Fix the thermometer in a vertical position, away from heat and direct sunlight. Press «C/F» to select the measurement unit. Specifications: Digital display: MAX/MIN temperature recorded -40+50° C / -40+120° F. Plastic body. Protection roof. AAA battery.

Sku. 129021250



White



NEW

MINI MAXI THERMOMETER HYGROMETER

Indoor or outdoor thermometer with digital display of temperatures. Temperature °C / °F. With mini-max. Wall hook.

Sku. 129021210



White



Sku. 129021218



Green



DIGITAL THERMOMETER EXTRA LONG PROBE WITH HANDLE

Digital thermometer extra long probe with handle, special for tanks, hay, cheese, ground, temperature control in inaccessible areas. Stainless steel probe # 340 suitable for food contact. Characteristics: Fixed probe very long : 1,45 m. -50° C to +200° C / -58° F to +392° F. Resolution: 0,1°. Accuracy: ±1° C / ±2° F. Big digit. Stainless steel probe # 340 (suitable for food contact: 1450 mm - Å 10 mm. Tip Protection. 1 battery LR03 AAA.

Sku. 129021560

Height: 145 cm







TRIGGER HOOK, ROUND ROTATING

Round Nickel-plated steel. By pair.

Sk. 130700500  3 338020 012633

Round - 20 mm 

Sk. 130700521  3 338020 012640

Round - 30 mm 

Sk. 130700530  3 338020 012657

Square - 20 mm 



TRIGGER HOOK, ROUND ROTATING RECTANGULAR

By unit.

Sk. 130700531  3 700393 922596

Nickel-plated iron 

TRIGGER HOOK, ROUND ROTATING OVAL

By unit.

Sk. 130700532  3 700393 922602

Oval - 20 mm - Nickel-plated iron 

SWIVEL EYE HOOK

By unit.

Sk. 130E702500  3 338025 099257

Galvanised - 20 mm 

Sk. 130E702521  3 338025 099264

Galvanised - 30 mm 

Sk. 130E702521010  3 338025 099226

Brass - 30 mm 



SWIVEL HOOK

Galvanized steel. By piece.

Sk. 130E702539  3 338025 107457

25 x 25 mm **Limited stock** 

SWIVEL HOOK

Nickel-plated steel. By pair.

Sk. 130700539  3 338020 012701

22 x 22 mm 

ATTACHMENT RING TO SCREW

With ring to screwing. Galvanized steel. Plate: 50 mm x 50 mm x 4 mm. Ring: Inside diameter: 50 mm. Thickness: 8 mm. By unit.

Sk. 130700620  3 338020 053001

5 cm 



CARABINER, 29 MM

By unit.

Sk. 130700535  3 700393 916977

29 mm 

SNAP HOOK OF PANIC, FIXED ROUND EYE

By unit.

Sk. 130700536  3 338020 052967

20 mm 

Sk. 130700537  3 338020 052974

25 mm 



PANIC HOOK

By unit.

Sk. 130E702537  3 338025 099288

Galvanised - 25 mm 

Sk. 130E702537010  3 338025 165334

Brass - 25 mm 



D RING UNIVERSAL TRIGGER HOOK

D-ring 3". By unit.

Sk. 130700547  3 338020 063307

12 cm / 5 inches **Limited stock** 



TIE RING

In galvanised steel. By unit.

Sku. 130E704120



1 x 1 cm
Limited stock



TRIGGER HOOK PLATE

For example, to attach a bucket to a wall.
5 cm. Galvanized. By unit.

Sku. 130700675



5 cm



SNAP HOOK

Galvanized.

Sku. 130700548



50 x 5 mm - By 5



Sku. 130700553



70 x 7 mm - By 5



Sku. 130700549



50 x 5 mm - By 10



Sku. 130700554



70 x 7 mm - By 10



Sku. 130700550



60 x 6 mm - By 5



Sku. 130700555



80 x 8 mm - By 5



Sku. 130700552



60 x 6 mm - By 10



Sku. 130700556



80 x 8 mm - By 10



Sku. 130700557



90 x 9 mm - By 3



Sku. 130700559



10 x 10 mm - By 3



Sku. 130700558



90 x 9 mm - By 10



Sku. 130700562



120 x 11 mm - By 3



QUICK LINK

Galvanized. By unit.

Sku. 130700563

5 cm



Sku. 130700564

6 cm



Sku. 130700565

7 cm



Sku. 130700566

8 cm



Sku. 130700567

10 cm



SPECIAL ADHESIVE TAPE FOR FILMS

For repairing damaged films (for example round bales, square bales and flat films). 10 cm wide and 10 m long. Extremely high adhesive power. Highly UV-resistant. Useful also on wet films.

Sku. 129280001

White



Sku. 129280002

Black



Sku. 129504040

Green





UKAL

—
**MILK AND MEAT
PROCESSING**

- 124 Milk processing
- 127 Meat processing
- 133 Professional knives



ELECTRIC CREAM SEPARATOR 85 L



An easy-to-handle electric cream separator for skimming small quantities of milk, with a capacity of 85 litres of milk per hour. A simple, economical solution for those needing to separate cream from milk from time to time.

Ideal for small farmers with some dairy cows, goats or sheep or for hobby farmers. This separator is perfect for processing on the farm or for individuals wishing to make their own cream at home.

This model produces approximately 7% to 10% cream. This will vary according to the composition of the milk and the temperature.

The housing, milk and cream outlets and the bowl holder are made of plastic. The milk bowl is made of aluminium. The top bowl and the top bowl discs are also aluminium. Min. fill quantity: 2 L Max. fill quantity: 12 L. **2-year warranty.**

Sku. 150600010

- 40 x 24 x 42 cm
- 230 V
- Motor power: 55W
- Rotating speed: 10,500 rpm



CREAM SEPARATOR AR 140 ECO



The cream separator MILKY AR 140 ECO allows the separation of small and medium quantities of milk. It is very easy to handle. We recommend the use of this cream skimmer for semi-professionals, in particular for breeders wishing to start processing milk on the farms. The ideal solution for smallholders of dairy cows, goats or sheep, but also for hobbyfarming. Materials: The body is made of plastic. The milk and cream outlets, the container holder and the milk container are made of polished, food-grade aluminium. The upper bowl and the discs in the upper bowl are also food grade. **2-year warranty.**

Sku. 150600020

- Aluminium
- 40 x 24 x 42 cm
- 230 V
- Moteur power: 60 W - RPM : 8500
- Rotating speed



MANUAL CREAM SEPARATOR FJ85



Manual cream separator for separating cream from milk. 85 litres of milk per hour. Allows the separation of all types of cow, goat or sheep milk. This model of creamer allows to obtain about 6% to 8% of cream. This percentage varies according to the composition of the milk and the temperature. The bowl, discs and outlets are made of food-grade aluminium. The body is made of plastic for easy cleaning. Number of roller discs: 11. min./max. filling capacity: 2-12 L. Dimensions: 36,5 x 36,5 x 53,5 cm. Weight : 7,5 kg . **2 years warranty.**

Sku. 150600030

Productivity: 85 L/h





BUTTER CHURN

The manual 10 L, electric 10 L and electric 32 L MILKY butter churns are ideal for small productions. of homemade butters. These machines are intended for semi-professionals, professionals, as well as for farmers wishing to start milk processing on farms. They are the perfect solution for smallholders of dairy cows, goats or sheep, but also for hobbyfarming. They allow an optimal yield of between 32 % and 42 % butter.

It consists of:

- a 10 litre or 32 litre cream container depending on the model.
- a removable stainless steel mixer
- a transparent plastic cover for permanent control
- a compartment for separating the buttermilk
- a multi-speed electric switch for individual control of butter production
- an automatic safety stop when the lid is removed during the process
- a powerful motor for speeding up or slowing down the butter production time.

Model 105 L available on order.

ELECTRICAL 10 L
Technical data:

- Tank volume: 10 L
- Working time per cycle: 20-35 min.
- Filling capacity from 1,5 to 3,8 L
- 4 speeds: 30 - 60 - 90 - 150 rpm
- Power: 550 W
- Dimensions: 39 x 33 x 31.5 cm
- Materials: plastic cover and stainless steel body

Sku. 150700010 

ELECTRICAL 32 L
Technical data:

- Tank volume: 32 L
- Working time per cycle: 20-35 min.
- Filling capacity from 6 to 13 L
- Power: 250/370 W
- Dimensions: 70 x 32 x 46 cm
- 2 speeds: 70 and 140 rpm
- Materials: plastic cover and stainless steel body

Sku. 150700030 



10 L



32 L





15 L



PASTEURIZER

The pasteurizers MILKY 15 L, 30 L, 50 L and 50 L with mixer allow the pasteurization of milk and juices, as well as the production of cheese, yoghurt and other dairy products. Can also be used for heating calf's milk (colostrum) for feeding, honey liquidation, honey wax production, etc. These machines are intended for semi-professionals as well as to farmers wishing to start milk processing on farms. They are the ideal solution for smallholders of dairy cows, goats or sheep, but also for hobbyfarming. The pasteurizer works on the model of a water bath. All pasteurizers consist of a removable filling tank, a double wall heated to the desired temperature, an inlet with a pipe for filling the double wall with cold water for cooling the milk, an outlet with a pipe for draining off the hot water, a thermometer on the lid, the lid lock for maintaining the heat and a control display (setting the water temperature + pasteurization heating time). The 50L pasteurizer with mixer also consists of:

- a mixer.
- a ctime setting.
- a stable mixer support for the table version (wheels for stable support).

Other models are available on request. Please see our website for more information on the products.

15 L

Technical data:

- Power: 230 W
- Tank volume: 15 L
- Filling capacity: 2 L-14 L
- Temperature setting: 4-100° C
- Time setting: 1 - 999 min
- Maximum temperature: 90°
- Dimensions: 32 x 32 x 52 cm
- Weight: 6 kg
- Stainless steel

Sku. 150800010



MEAT MINCER



Semi-professional meat mincers REBER are intended for professionals who want robust and quality equipment for the processing of their minced meat and the production of homemade fillings. From farmers to meat professionals (butchers, charcutiers and caterers), we offer you a complete range of meat processing on the farm. The meat grinders have a hourly production from 30 to 160 kg and are guaranteed for 2 years. REBER brand of 100 % Italian manufacture. Guarantee of quality. All the meat mincers consist of an induction motor with continuous operation, an oil bath gearbox with a Long Life type oil suitable for contact with food, AISI 430 stainless steel fairing, body, propeller and a nut made of food certified tinned cast iron, a top plate made of stainless steel AISI 304, a steel plate, a knife made of C55 steel as standard and a pulse reversal switch.

Sku. 150100001	Meat mincer REBER N5 - 400 W • Dimensions: 35 x 17 cm • Height: 26,5 cm • Weight: 9 kg • Hourly production: 30/50 kg • Grid hole: 6 mm	
Sku. 150100002	Meat mincer REBER N12 - 500 W • Dimensions: 54 x 22 cm • Height: 32 cm • Weight: 16,3 kg • Hourly production: 50/90 kg • Grid hole: 6 mm • 2 funnels provided for gutting	
Sku. 150100003	Meat mincer REBER N22 Classic 600 W • Dimensions: 51 x 23 cm • Height: 33 cm • Weight: 31,3 kg • Hourly production: 70/120 kg • Grid hole: 8 mm	
Sku. 150100004	Meat mincer REBER N32 - 1200 W • Dimensions: 58 x 25,5 cm, • Height: 36 cm • Weight: 29,3 kg • Hourly production: 100-160 kg, • Grid hole: 10 mm	



TOMATO MILL MACHINE



Make delicious tomato sauces and purées, fruit juices and jams at home. Easily remove seeds from tomatoes and other fruit. Nylon body and worm screw. Treated with food grade resin. Supplied with hopper, splash guard, stainless steel strainer and filter and plastic pusher. Well made, durable item. Easy to clean. 2 years warranty. **Delivered without motor.**

Sku. 150150001	NO. 3 - Compatible with 400-W mincers (150100001). Weight: 1,2 kg		
Sku. 150150002	NO. 5 - Compatible with 500 W (150100002), 600 W (150100003) and 1200 W (150100004) mincers. Weight: 2,2 kg		





STAINLESS STEEL SAUSAGE FILLING MACHINES

The sausage filling machines have a stainless steel tube, a square bar steel rack to guarantee a major power take-off surface, a nylon 6,6 piston support, a cover, a piston and a plastic gasket for food use. We offer vertical or horizontal REBER plungers with capacities from 3 to 15 kg. All sausage filling machines have 2 speeds and are supplied with 4 funnels: 19, 25, 30 and 40.



Sausage filling machines REBER 2 speeds 5 kg PRO
 Sku. 15020001
 • Capacity: 5 L
 • Dimensions: 57,5 x 33,5 cm
 • Height: 20,5 cm
 • Weight: 10,5 kg



Sausage filling machines REBER 2 speeds 8 kg PRO
 Sku. 15020002
 • Capacity: 8 L
 • Dimensions: 67 x 33,5 cm
 • Height: 20,5 cm
 • Weight: 11,9 kg

Sausage filling machines REBER 2 speeds 10 kg PRO
 Sku. 15020003
 • Capacity: 10 L
 • Dimensions: 74 x 41 cm
 • Height: 22 cm
 • Weight: 19,4 kg

Stainless steel sausage filling machines REBER 2 speeds 5 kg PRO
 Sku. 150201001
 • Capacity: 5 L
 • Dimensions: 57,5 x 33,5 cm
 • Height: 20,5 cm
 • Weight: 10,4 kg

Stainless steel sausage filling machines REBER 2 speeds 8 kg PRO
 Sku. 150201002
 • Capacity: 8 L
 • Dimensions: 67 x 33,5 cm
 • Height: 20,5 cm
 • Weight: 11,9 kg

Stainless steel sausage filling machines REBER 2 speeds 10 kg PRO
 Sku. 150201003
 • Capacity: 10 L
 • Dimensions: 74 x 41 cm
 • Height: 22 cm
 • Weight: 19,4 kg

Stainless steel sausage filling machines REBER 2 speeds 15 kg PRO
 Sku. 150201004
 • Capacity: 15 L
 • Dimensions: 86 x 26 cm
 • Height: 29 cm
 • Weight: 25 kg

Stainless steel sausage filling machines REBER 2 speeds 3 kg PRO vertical
 Sku. 150202001
 • Capacity: 3 L
 • Dimensions: 28 x 24 cm
 • Height: 60 cm
 • Weight: 8,5 kg

Stainless steel sausage filling machines REBER 2 speeds 5 kg PRO vertical
 Sku. 150202002
 • Capacity: 5 L
 • Dimensions: 40 x 31 cm
 • Height: 70 cm
 • Weight: 14 kg



FOOD SLICER



The ham slicers REBER, with 20 or 25 cm blades, are designed for professionals who want robust and quality equipment for cutting their meat, sausages and fish. From breeders to professionals in the meat industry (butchers, pork charcutiers and caterers), we offer you a complete range of meat processing. The ham slicers are guaranteed for 2 years. REBER brand of 100 % Italian manufacture. Guarantee of quality. They have a die-cast aluminium base varnished with steel effect, a professional tempered and fitted 200 m steel blade with fixed protective ring, a movable partition made of molten aluminium with steel tips, a blade protector, a tray and a wall made of molten aluminium with a simple cleaning system, a blade shaft mounted on double ball bearing, a ventilated 140 W professional motor, a safety button, a cutting thickness adjustment, a double ball bearing, a ventilated 140 W professional motor, a safety button, a cutting thickness adjustment. From 0 to 16 mm.



REBER food slicer 20 cm blade

- Motor power: 140 W
- Dimensions: 46,5 x 34,5 cm
- Height: 29,5 cm
- Weight: 10 kg
- Cutting thickness adjustment from 0 to 16 mm
- Removable sharpener NOT INCLUDED available on request

Sku. 15030001



REBER food slicer 25 cm blade with sharpener

- Motor power: 140 W
- Dimensions: 53 x 48 cm
- Height: 37,5 cm
- Weight 13 kg
- Cutting thickness adjustment from 0 to 16 mm
- Fixed sharpener INCLUDED

Sku. 15030002



NEW

UKAL

SMOKER

Essential for smoking meat, sausages or even fish! This smoker is made from 0,8 mm thick galvanised sheet metal and has a hinged door. Thermometer and 10 hooks included. Smoker for flat smoking or vertical hanging smoking. Easy to assemble. Sawdust not included. **Made in Europe.**

Sku. 150250001 With glass door -
Dimensions:
80 x 39 x 27,5cm -
3 levels



Sku. 150250002 With full door -
Dimensions:
110 x 46 x 28 cm -
5 levels



AUTOMATIC VACCUM MACHINES



REBER automatic vacuum packing machines are ideal for automatically vacuum packing food. We recommend these machines for family, semi-professional or professional use. From farmers to meat professionals (butchers, charcutiers and caterers), we offer you a complete range of meat processing on the farm. The vacuum packing machines are easy to use, operate without stopping and waiting for cooling and are guaranteed for 2 years. All machines are supplied with 20 bags of 20 x 30 cm. They are equipped with an energy saving system. **For optimal vacuum packing, we strongly recommend the use of REBER bags. We do not guarantee the quality of the vacuum if bags of other brands are used.**



Vacuum packing machine REBER automatic SALVASPESA PLUS

- Colour: white
- Dimensions: 37,5 x 17,5 x 11,5 cm.
- Weight: 3 kg
- Power: 180 W
- Empty: -830 mbar
- Suction: 18 lt/min
- Sealing bar: 32 cm

Sku. 150400001



8 013152 934606

Vacuum machine REBER automatic FAMILY DE LUXE

- Colour: silver
- Dimensions: 43,5 x 15,5 x 11 cm
- Weight: 3 kg
- Power: 190 W
- Empty: -830 mbar
- Suction: 18 lt/min
- Sealing bar: 32 cm. Supplied with suction hose for box

Sku. 150400002



8 013152 970116

Vacuum packing machine REBER stainless steel 30 cm (not illustrated)

- Colour: silver
- Dimensions: 37 x 27 x 11 cm
- Weight: 6,5 kg
- Power: 280 W.
- Empty: -900 mbar
- Suction: 40 lt/min
- Sealing bar: 32 cm. Supplied with a Hose connection for containers

Sku. 150400003



8 013152 970970

Vacuum packing machine REBER stainless steel 40 cm

- Colour: silver
- Dimensions: 47 x 27 x 12 cm
- Power: 335 W
- Weight: 7,8 kg
- Empty: -900 mbar
- Suction: 40 lt/min. Supplied with a hose connection for containers.
- Sealing bar: 43 cm

Sku. 150400004



8 013152 971694

ELECTRONIC FOOD THERMOMETER



Electronic cooking thermometer for monitoring the temperature of meat, cheese etc. For hot or frozen food. Memory and digital temperature display. Also suitable for monitoring the temperature of air conditioning or soil. It can be boiled.

- Technical data:**
- Waterproof.
 - Comes with battery.
 - Scale range in Celsius: -50° C to +200° C.
 - Scale range in Fahrenheit: -58° F to +392° F.
 - With min. and max. action.
 - Length: 20 cm.

Sku. 129027 20 cm



3 700393 922107



VACUUM BAGS AND ROLLS



Vacuum bags and rolls REBER are ideal for optimal vacuum packaging for the preservation of your food fresh. They are resistant and airtight. We recommend these bags and rolls for professionals. From breeders to meat professionals (butchers, pork charcutiers and caterers), we offer you a complete range of meat processing. The vacuum bags and rolls are easy to use. REBER brand of 100 % Italian manufacture. **Guarantee of quality. REBER bags are tested for vacuum cooking up to a temperature of 100°C for a maximum of 4 hours. We recommend cooking at 60° C for 24 hours.** REBER triple-layer bags have all these qualities: 2 inner polyethylene layers suitable for contact with food, 1 outer layer of polyamide which guarantees airtightness against air penetration, 2 layers of polyethylene. These layers make the bag more resistant to punctures and tears and prevent the penetration of moisture, reduce the risk of leakage and the formation of frost and ice crystals in the freezer. Finally, the special indentations on the surface promote the exit and leakage of air and allow the creation of a true vacuum.

Sku. 150500015	100 embossed bags 15 x 25 cm	8 013152 674205
Sku. 150500020	100 embossed bags 20 x 30 cm	8 013152 672300
Sku. 150500025	100 embossed bags 25 x 35 cm	8 013152 672416
Sku. 150500030	100 embossed bags 30 x 40 cm	8 013152 673505
Sku. 150510020	2 rolls 20 x 600 cm	8 013152 672607
Sku. 150510030	2 rolls 30 x 600 cm	8 013152 672508
Sku. 150520005	50 bags 40 x 50 cm 105 microns	8 013152 672591
Sku. 150520006	50 bags 40 x 60 cm 105 microns	8 013152 672430



NEW

VACUUM BAGS AND ROLLS

UKAL

Bags for vacuum packaging machines. They extend the shelf life of food up to 3 times. In PA/PE. Thickness 105 microns. Made in Europe. **Excellent value for money.**

Sku. 150530001	50 bags 12 x 30 cm	3 831107 706437
Sku. 150530002	50 bags 12 x 55 cm	3 831107 706451
Sku. 150530003	50 bags 15 x 25 cm	3 831107 706475
Sku. 150530004	50 bags 15 x 40 cm	3 831107 706468
Sku. 150530005	50 bags 18 x 25 cm	3 831107 706444
Sku. 150530006	50 bags 20 x 30 cm	3 831107 706482
Sku. 150530007	50 bags 20 x 40 cm	3 831107 706420
Sku. 150530009	50 bags 25 x 35 cm	3 831107 706796
Sku. 150530010	50 bags 25 x 40 cm	3 831107 706512
Sku. 150530011	50 bags 30 x 40 cm	3 831107 706499
Sku. 150530012	50 bags 30 x 50 cm	3 831107 706505
Sku. 150540001	2 rolls 12 x 600 cm	3 831107 728187
Sku. 150540002	2 rolls 15 x 600 cm	3 831107 733303
Sku. 150540003	2 rolls 20 x 600 cm	3 831107 733204
Sku. 150540004	2 rolls 30 x 600 cm	3 831107 733211





GRIDS FOR MEAT MINCER REBER

You will find all our mincer grids: 4,5 mm, 6 mm, 8 mm, 10 mm, 12 mm. Depending on the desired result (minced meat, sausages, pâtés). These Grids are made of steel, which gives them a clean cut of the meat.



Sku. 9REB4007A/4	Grid 4,5 mm - Meat mincer N°5 REBER	8 013152 050405
Sku. 9REB4007A/8	Grid 8 mm - Meat mincer N°5 REBER	8 013152 050801
Sku. 9REB4007A/10	Grid 10 mm - Meat mincer N°5 REBER	8 013152 051006
Sku. 9REB4007A/12	Grid 12 mm - Meat mincer N°5 REBER	8 013152 051204
Sku. 9REB4312A/4	Grid 4,5 mm - Meat mincer N°12 REBER	8 013152 120412
Sku. 9REB4312A/8	Grid 8 mm - Meat mincer N°12 REBER	8 013152 120818
Sku. 9REB4312A/10	Grid 10 mm - Meat mincer N°12 REBER	8 013152 121013
Sku. 9REB4312A/12	Grid 12 mm - Meat mincer N°12 REBER	8 013152 121211
Sku. 9REB4312A/1	Diamond grid 3 holes - Meat mincer N°12 REBER	8 013152 431211
Sku. 9REB4714A/4	Grid 4,5 mm - Meat mincer N°22 REBER	8 013152 220419
Sku. 9REB4714A/6	Grid 6 mm - Meat mincer N°22 REBER	8 013152 220617
Sku. 9REB4714A/10	Grid 10 mm - Meat mincer N°22 REBER	8 013152 221010
Sku. 9REB4714A/12	Grid 12 mm - Meat mincer N°22 REBER	8 013152 221218
Sku. 9REB4714A/1	Diamond grid 3 holes - Meat mincer N°22 REBER	8 013152 471415
Sku. 9REB4750A/4	Grid 4,5 mm - Meat mincer N°32 REBER	8 013152 320409
Sku. 9REB4750A/6	Grid 6 mm - Meat mincer N°32 REBER	8 013152 320607
Sku. 9REB4750A/8	Grid 8 mm - Meat mincer N°32 REBER	8 013152 320805
Sku. 9REB4750A/12	Grid 12 mm - Meat mincer N°32 REBER	8 013152 321208



KNIVES FOR MEAT MINCER

Knives for meat mincer. Material: Steel type C55.

Sku. 9REB4006A	Knife TC 5	8 013152 400606
Sku. 9REB4311A	Knife TC 12	8 013152 120115
Sku. 9REB4712A	Knife TC 22	8 013152 220112
Sku. 9REB4752A	Knife TC 32	8 013152 475208



Based in the small Italian village of Premana, the MAGLIONERO brand has made a name for itself, over the last 50 years, in the craft manufacturing of professional knives. Its state-of-the-art factory works with chefs to design knives that cater as closely as possible to their needs. Its range now includes not only knives, but also complementary accessories such as sharpeners and products to care for your knives.



NEW

CLEAVER



This knife is specifically designed to work on large pieces of meat that are difficult to cut with a conventional knife. It is used for splitting or cutting bones. Made of AISI 420 stainless steel with a hardness of 52HRC. It has an ergonomic and sturdy handle to facilitate the cutting work. 1 year warranty.

Sk. 150310000



Blade: 22 cm
Length: 40 cm
Weight: 1,3 kg



Sk. 150310001



Blade: 26 cm
Length: 44 cm
Weight: 1,3 kg



NEW

CLEAVER "FRANCESE"



This knife is specifically designed for slicing, splitting or cutting up large carcasses (meat, poultry, etc.). Made of AISI 420 stainless steel with a hardness of 52HRC. It has an ergonomic and sturdy handle to facilitate cutting work. 1 year warranty.

Sk. 150310002



Blade: 24 cm
Length: 35 cm
Weight: 0,8 kg



NEW

BONE SAW WITH SCREW



This butcher's knife makes it easy to cut meat carcasses and bones. Its steel hoop will ensure better stability when cutting. It has a screw blade that can easily be changed. Made of AISI 420 stainless steel with a hardness of 52HRC. It has an ergonomic and sturdy handle for easy cutting. 1 year warranty.

Sk. 150310004



Blade: 50 cm
Length: 64 cm
Weight: 1 kg



Sk. 150310005



Blade: 50 cm
Weight: 40 g
Supplied alone



NEW

BUTCHER KNIFE "COLPO" ANATOMIC



This perfectly balanced chef's knife can be used for chopping and cutting meat, fish, fruit and vegetables - in short, the all-rounder. Made of AISI 420 stainless steel with a hardness of 52HRC. It has an ergonomic and sturdy handle for easy cutting. 1 year warranty.

Sk. 150310003



Blade: 28 cm
Length: 42 cm
Weight: 1 kg



NEW

BONING KNIFE LUX LINE



Frequently used in the butcher's shop, the boning knife allows, with its thin and curved blade, to bone, de-bone and degrease large pieces of butchery, game and poultry. Professional knives made from Bonpertuis X50CrMov15 stainless steel. Polished surface. Ergonomic, robust and refined handle for easy cutting. High grip and durability. Sterilisable material. 1 year warranty.



Sku. 150310006



Blade: 13 cm
Length: 26 cm
Weight: 90 g



NEW

BREAKING KNIFE LUX LINE



The breaking knife has a thin, curved blade for easy cutting and boning of meat pieces. Professional knives made from Bonpertuis X50CrMov15 stainless steel. Polished surface. It has an ergonomic, robust and refined handle for easy cutting. High grip and durability. Sterilisable material. 1 year warranty.



Sku. 150310007



Blade: 26 cm
Length: 38,5 cm
Weight: 150 g



NEW

STICKING KNIFE LUX LINE



This multi-purpose knife is ideal for everyday use for carving vegetables, making a garnish, chopping herbs...it can also be used for filleting small fish and cutting different pieces of meat. Professional knives made from Bonpertuis X50CrMov15 stainless steel. Polished surface. It has an ergonomic, robust and refined handle to facilitate cutting. High grip and durability. Sterilisable material. 1 year warranty.



Sku. 150310008



Blade: 14 cm
Length: 26 cm
Weight: 110 g



NEW

KITCHEN KNIFE FLUTED EDGE LUX LINE



This kitchen knife with fluted edge is versatile for your preparation tasks. The wide 21 cm blade makes it easy to slice through even the toughest foods without effort. The fluted edges help prevent food from sticking to the blade allowing you to complete preparation tasks quickly. Professional knives made from Bonpertuis X50CrMov15 stainless steel. Polished surface. Ergonomic, robust and refined handle for easy cutting. High grip and durability. Sterilisable material. 1 year warranty.



Sku. 150310009



Blade: 21 cm
Length: 33 cm
Weight: 160 g



NEW

BUTCHER KNIFE LUX LINE



The French kitchen knife is used for various cutting tasks: meat, fish, fruit and vegetables. Its very resistant blade is very popular with chefs. A precision tool that will serve you for years. Professional knives made from Bonpertuis X50CrMov15 stainless steel. Polished surface. Ergonomic, robust and refined handle for easy cutting. High grip and durability. Sterilisable material. 1 year warranty.

Sku. 150310010	Blade: 16 cm Length : 29 cm Weight: 130 g		
Sku. 150310011	Blade: 18 cm Length : 31 cm Weight: 140 g		
Sku. 150310012	Blade: 20 cm Length : 33 cm Weight: 160 g		
Sku. 150310013	Blade: 23 cm Length : 36 cm Weight: 180 g		
Sku. 150310014	Blade: 26 cm Length : 39 cm Weight: 200 g		



NEW

BREAD KNIFE LUX LINE



The bread knife has a large blade with sharp teeth for cutting all types of bread. It can also be used to cut fruits and vegetables with a hard skin. Professional knives made from Bonpertuis X50CrMov15 stainless steel. Polished surface. It has an ergonomic, robust and refined handle for easy cutting. High grip and durability. Sterilisable material. 1 year warranty.

Sku. 150310015		
Blade: 21 cm Length: 33,5 cm Weight: 100 g		



NEW

FISH KNIFE LUX LINE



The fish knife is recommended for quality cutting of fish. Its solid 18 cm blade will provide precision when cutting. Professional knives made from Bonpertuis X50CrMov15 stainless steel. Polished surface. It has an ergonomic, robust and refined handle to facilitate cutting. High grip and durability. Sterilisable material. 1 year warranty.

Sku. 150310016		
Blade: 18 cm Length: 31 cm Weight: 70 g		



NEW

CHROME PLATED CIRCULAR SHARPENING STEEL



The professional sharpening gun is the ideal tool for sharpening all your knives quickly and easily. It offers a very good resistance to wear. Its handle is comfortable and offers a good support during the sharpening operation. 1 year warranty.

Sku. 150310017	Round blade: 20 cm Length: 32,5 cm Weight: 170 g		
Sku. 150310018	Round blade: 30 cm Length: 44 cm Weight: 390 g		
Sku. 150310019	Oval blade: 30 cm Length: 44 cm Weight: 390 g		



NEW

**FORGED COOKS
FORK POMHANDLE**



The meat fork has long prongs to hold the meat when cutting, it also allows you to turn and move your food when cooking. The length of the tines of 20 cm allows an optimal holding of the food. The handle is ergonomically designed, robust and refined for easy handling of food. High grip and durability. Sterilisable material. 1 year warranty.

Sku. 150310020



Teeth: 20 cm
Length: 32 cm
Weight: 170 g



NEW

POULTRY SHEARS



These stainless steel poultry scissors are designed for professionals who want to cut up poultry. With its high quality finish, it offers a clean and precise cut. It is robust and allows you to easily cut through the bones and gristle of poultry to prepare the meat. The ergonomic, robust and refined handle makes it easy to work with food. High grip and durability. Sterilisable material. 1 year warranty.

Sku. 150310021



Blade: 11 cm
Length: 25 cm
Weight: 380 g

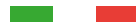



UKAL

— POULTRY

- 138 Incubation
- 142 Chicken coop
- 144 Feeders & drinkers
- 156 Rings
- 157 Well-plucked
- 158 Rabbits



BOROTTO designs and produces technologically advanced, high performance incubators, operating in compliance with advanced quality standards UNI EN ISO 9001 certified. By taking completely original ideas and developing them into revolutionary technical applications, three of which have been patented, Borotto has made its mark in the field of artificial incubation.



Incubators



LUMIA 8 INCUBATOR AUTOMATIC DIGITAL



- In Heat-Resistant ABS with Biomaster.
- Lumia 8: A small, technologically advanced, high performance machine. Its elegant design with "smart" technology makes this machine smart and easy to use and one of the best in its class.
- Lumia 8 stems from a desire to make the miracle of life available to all. It includes the highest professional incubation technology aimed at those with a limited number of eggs. The same technology that Borotto uses in larger models that can reach a higher level of accuracy and reliability.
- Lumia 8 is designed and built to better meet farmyard poultry and valuable species breeding requirements. Thanks to the use of innovative materials and a functional and ergonomic design, Lumia 8 is an indispensable instrument that is easy to use, both for the professional breeder and for all new breeding enthusiasts who want to try breeding farmyard animals for the first time, with expectations of a good result.

Dimensions : 39 x 22 x 20 cm.

Sku. 530300008 8 eggs

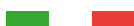

LUMIA 16 INCUBATOR PATENTED AUTOMATIC DIGITAL



- In Heat-Resistant ABS with Biomaster.
- Lumia 16: A small, technologically advanced, high performance machine. Its elegant design with "smart" technology makes this machine smart and easy to use and one of the best in its class.
- Lumia 16 stems from a desire to make the miracle of life available to all. It includes the highest professional incubation technology aimed at those with a limited number of eggs. The same technology that Borotto uses in larger models that can reach a higher level of accuracy and reliability.
- Lumia 16 is designed and built to better meet farmyard poultry and valuable species breeding requirements. Thanks to the use of innovative materials and a functional and ergonomic design, Lumia 16 is an indispensable instrument that is easy to use, both for the professional breeder and for all new breeding enthusiasts who want to try breeding farmyard animals for the first time, with expectations of a good result.

Dimensions : 39 x 34 x 24 cm.

Sku. 530300016 16 eggs





Automatic turning.



Digital temperature.



Outdoor filing.

DIGITAL SEMI AUTOMATIC INCUBATOR



Our digital incubators are designed to be simple and straightforward to use, at the same time offering innovative technical solutions and high reliability. Digital display. It is possible to set the temperature from 32°C to 40°C with 0.1°C steps by pressing the (+) and (-) buttons (Programme Mode). Inspection windows allow to follow each phase of the incubation. Mouths to fill the water trays from outside, avoiding the opening of the incubator and the dispersion of heat and humidity.

Sku. 530200024	24 eggs	8 053840 870038
Sku. 530200049	49 eggs	8 068056 992030



DIGITAL AUTOMATIC INCUBATOR



The incubator is ideal for chicken eggs, pheasant, guinea fowl, quail, partridges, duck, mallard, goose, turkey, peacock, bartavelle, pigeon, hake, exotic birds and birds of prey. Digital Display temperature control with decimal point. Range Temperature changeable from a Min of 30°C to a Max of 40°C. Precise electronic thermostat $\pm 0.1^\circ\text{C}$. Ventilation with turbine, diameter 100mm. **One complete inclination every 2 hours. 220V.**

Sku. 530300024	24 eggs	8 053840 870045
Sku. 530300049	49 eggs	8 053840 870069
Sku. 530200	Motor for digital incubator automatic	8 068056 992092 





Incubator accessories



EGG CANDLER

This product is intended for the control of egg incubation. Using this egg spotter, you can check for the presence of cracks on the shell and the fertilisation of the egg and the stage of development of the embryo. Works on area 220 V. maximum power: 15W. Delivered with two rubber inserts.



Sku. 530002010  3 700393 919640



SPARE THERMOMETER

Display of 25° C to 45° C.

Sku. 530050001  3 338020 087822
 Straight **Limited stock** 

Heating plates



EGG SPOTTERS ADVICES

Apart from the presence of cracks and the stage of development of the embryo, you can also inspect the proportion of air inside the egg. Indeed, this percentage allows you to determine and adjust the level of humidity of your incubator, which is essential to the success of a good breeding. The diagram on the left shows the correspondence between the proportion of air and the number of days of incubation. Adjust your humidity as a function of the air proportion observed.

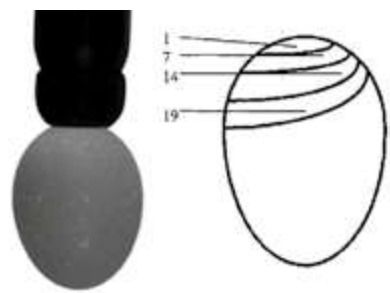

HEATING PLATE FOR CHICKS

Provides a very soft as if under distributed warmth on the surface. The chicks will nest there as under the wing of their mother. Adjustable height to adapt to the growth of the chicks and splash-proof. Shell in very resilient plastic with insulation, washable and supporting water splashes. Cover available upon request.

Sku. 530005025	25 x 25 cm 15-20 chicks	 8 718426 005289	1	
Sku. 530005040	40 x 40cm 30-35 chicks	 8 718426 004251	2	
Sku. 530005050	40 x 50cm 40-45 chicks	 8 718426 004275	3	
Sku. 530005060	40 x 60cm 50-55 chicks Limited stock	 8 718426 004299	4	



Cage

CHICKS AND QUAIL REARING CAGE

Ultra-practical between the incubator and the poultry house. Feeding trough and drinking trough for 150 chicks. After the incubator, the small paradise for the chicks before joining the poultry house! The opening is on the top. This breeder contains a retrieval tray for droppings. Very easy to maintain. Feel free to add a heating lamp to keep your chicks warm. To assemble yourself.

Sku. 531100 150 chicks 3 700393 911996



→ Please, have a look p. 67 to discover our light bulbs offer.



NEW 2024

CHICK'A BIOTIC

The first PROBIOTICS food supplement

for healthy and strong poultry!



POULTRY | Chicken coop

Automatic doorkeeper



EXTREM AUTOMATIC CHICKEN COOP DOOR OPENER



Opens & closes your chicken coop using a timer & light sensor. Manually open and close your chicken coop with a push of a button. Fully featured LCD display for ease of use. Multiple power sources. Choose from 4 x AA alkaline batteries, USB or DC Power. Automatic stop feature. Automatic door calibration. **Has a 4 kg** door lifting capability. New features include: Automatic door calibration to make the installation process as simple as possible; Automatic stop feature which protects your chickens from getting trapped as the door lowers and also prevents the string from getting tangled if there is an obstruction; Choose from 4 x AA Alkaline batteries, USB or DC power (6 V to 12 V - cables not included). Battery warning light visible from 100 meters away. Backup lithium cell battery (CR1220 Lithium cell battery not included) that will keep the clock working when the batteries run out or while replacing them. New self-diagnosis capability with an alert message appearing on the screen until the required action has been taken. Warranty: 2 years.

Sku. 595607100



Controlled by timer and/or light sensor

Litter



NEW IN 2024

COCONUT HUSK CHIP POULTRY LITTER

100% natural poultry litter made from coconut husk chips. Ultra-absorbent. Neutralises odours. pH: 5,5 - 6,5. Absorbency. For indoor and outdoor use. Composition : Coconut fibre. Organic matter content: 80 %. Biodegradable and compostable.

Sku. 000800

100 L



NEW



AUTOMATIC DOORMAN FOR CHICKEN COOP



This automatic door opener operates either on a timer or with a light sensor to manage the opening and closing of your chicken coop door. You can opt for default mode which uses a light sensor to detect the ambient light level or you can programme opening and **closing using the timer (12 hr / 24 hr)**. Manual opening/closing possible. Battery economy mode: the screen goes off after 120 seconds. This door opener includes an animal detection feature. It is powered by 2 x AA alkaline batteries or a 5 VDC adapter (not included). Add a solar panel (max. 10W) for even more autonomy. **Ideal for smaller standard size hens.**

Sku. 595614



Controlled by timer and/or light sensor

CHICKEN GUARD LOCKABLE DOOR



The Chicken Guard lockable henhouse hatch is the revolutionary hatch! The result of our collaboration with Chicken Guard, it is innovative and ingenious. It has a clever locking mechanism that prevents any predator from lifting the hatch once it is closed. Made of quality materials (frame and rails made of tough ABS plastic, brushed aluminium fronts), it is the most accomplished of all the traps on the market! It can be fitted on any henhouse. Colour: grey. Weight: 800 g.

Sku. 595610



Dimensions: 30 x 60 cm
Limited stock



Cleaning and disinfecting

NEW

DIATOMACEOUS EARTH (NON-CALCINED)



Non-toxic to humans, it can be used indoors and outdoors. Contains no chemicals. As well as being the ideal way to sanitise a chicken coop, it can also be used to absorb pet odours. Technological additive, per kg. Kieselguhr (diatomaceous earth, purified) (E551c) 1.000.000 mg.



Sku. 000700 3 700393 923968

1 kg

Sku. 000700300 3 700393 982910

3 kg



Nests

NESTING BOXES

Fully galvanised. Bottom in inclined mesh allowing an easy collection of always clean eggs and protects against cannibalism.

Sku. 400011 Double nesting nest, 63 x 45 x 35 cm 3 700393 912016



PHEASANT EGGS GREEN PAINTED WOOD

Lure in wood, green. Allows fixing of the place of egg laying.

Sku. 520005 3 338020 051618

By 2

Limited stock



PAINTED WOOD HEN EGGS

Lure in painted wood. Allows fixing of the place of egg laying.

Sku. 520001003 3 700393 933905

By 3



NATURAL WOOD HEN EGGS

Lure in natural wood. Allows fixing of the place of egg laying.

Sku. 520002003 3 700393 933912

By 3

Limited stock



CERAMIC HEN EGGS

Lure in ceramic. Allows fixing of the place of egg laying.

Sku. 520010003 3 700393 933929

By 3



POULTRY | Colorful range

Plastic drinkers



DRINKER WITH HANDLES

Drinker with ankle. Delivered with feet.

Sku. 510100005	5 L		
		3 700393 962318	10
Sku. 510100015	15 L		
		3 700393 962325	4

Plastic feeders



FEEDER WITH PLASTIC FEET

Adjustable with Greenical nylon rod. Delivered with feet.

Sku. 505100009		
	3 700393 962349	5
9 L		
Sku. 505100020		
	3 700393 962394	5
20 L		



COLORFUL PLASTIC FEEDER

In yellow, orange or red plastic!! Practical and easy to clean. 18 kg.

Sku. 505018019	
	3 700393 964114
10 to 13 hens	
Limited stock	



COMPACTA FEEDER BIG CAPACITY

The feeder is made of durable plastic. The yellow body is a unique piece that supports itself without the need for a central stem or sleepers. It is very easy to assemble. The amount of food in the dish can be adjusted through one of three holes provided. The feeder is provided with lid and can be placed on the ground or suspended. The anti-waste gate and the suspension ring are integrated in the body. Design facilitates stacking, optimizing spaces. **The feeder is delivered without feet.** Feet available Sku. 505100P.

Sku. 509100008		
	3 700393 915673	10
8 kg		
Sku. 509100015		
	3 700393 962332	10
15 kg		



CHICK FEEDER 50CM GREEN

In plastic! Practical and easy to clean.

Sku. 505050008	
	3 700393 964282
15 chicks	



HEN FEEDER 75 CM PINK

In coloured plastic! Practical and easy to clean.

Sku. 508075021	
	3 700393 962424
20 hens	



Plastic drinkers

TRANSPARENT BLUE DRINKING TROUGH



In blue plastic. Practical and easy to clean.

Sku. 510100006



5 L with handle



"ECO" DRINKING TROUGH FOR CHICKENS



Highly resistant antibacterial plastic drinkers, ideal for chickens. **Easy refill thanks to the cap.**

Sku. 510200006



8 L - 8 hens



POULTRY GRAVITY DRINKERS WITH TWISTED CAP OR BAYONET CLOSURE



Made of high quality plastic, very UV resistant. Professional design. Easy to clean.

Sku. 510103001



1 L - with twisted cap

Sku. 510103041



4 L - with bayonet closure and handle

Sku. 510103008



8 L - with bayonet closure and handle



MULTIFUNCTION DRINKER «MAXI CUP»



The drinker is easily attached to all types of tanks up to 180cm water depth. This tank fills half automatically. It is easy to install and use and is very easy to maintain. Adapts to several varieties of animals (chickens, birds...). Indoor or outdoor use.

Sku. 510103005



0,5 L



POULTRY DRINKER



Made of high quality plastic, very UV resistant. Professional design. Easy to clean.

Sku. 510103006

0,6 L



Sku. 510103013

1,3 L



Sku. 510103040

4 L - with handle



Sku. 510103065

6,5 L - with handle



Sku. 510103012

12 L - with handle



POULTRY | Colorful range

Plastic feeders



BLUE TRANSPARENT FEEDER

Easy to use and easy to clean. Can be hung.

Sku. 505004006	4 kg		
-----------------------	------	---	---



POULTRY FEEDER «MOUNTAIN»

The «Mountain» feeders are very resistant thanks to their high quality plastic, and they are easy to clean. Thanks to its automatic feeding system, your birds will always receive fresh feed. Its conical shape is particularly suitable for this use. This range can be used suspended or laid directly on the floor. Possibility to adjust the dosage thanks to its height. UV protection for a better resistance. Feeder entirely made of plastic and very UV resistant. Easy maintenance. Can be used suspended or placed on the ground, adjustable by height adjustment.

Sku. 505300015	1,5 kg Without lid		
Sku. 505300003	3 kg With lid		
Sku. 505300005	5 kg With lid		
Sku. 505300008	8 kg With lid		



Drinkers**METAL BUCKET
CONSTANT LEVEL DRINKING
TROUGH**

Metal bucket constant level drinking trough.

Sku. 501112



12 L

**TRIPOD GALVANISED
DRINKER**

Tank drinking trough in galvanised steel on steel tripod. The height of the drinking trough cup allows poultry to have permanently available good quality water.

Sku. 510002030



22 L

**Feeders****FEEDER ANTI-PESTS**

The automatic opening of the hopper is done by simple pressure when poultry goes to the feeding trough. Avoids pests being introduced into the food. Delivered with lid.

Sku. 400001



15 L - 10 hens

Sku. 400002



30 L - 20 hens

**FEEDING TROUGH
WITH HOPPER**

For breeding with anti - waste edge and rain canopy protection placed on or hanging from the rear.

Sku. 400003



10 L - 8 hens

Sku. 400004



18 L - 13 hens

Sku. 400005



25 L - 17 hens

**FEEDER WITH ROOF
AND ROTATING ROLL**

Roll of 60cm, capacity 4,2 L. Completely galvanised. The turning roller prevents pigeons from roosting.

Sku. 400006



4,2 L - 15 hens

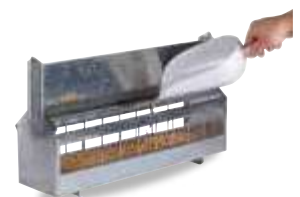



ENAMELLED HEN FEEDER WITH HOPPER

Control of flow by rack and pinion. Ideal product for feeding outdoors poultry and small game without the risk of waste and pollution of food. In galvanized sheet.

Sku. 500009	5 L - 6 hens	3 338020 012848
Sku. 500010	25 L - 17 hens	3 338020 012855
Sku. 500011	40 L - 25 hens	3 338020 012862



FEEDER WITH MOVABLE GRILL FOR CHICKS

Galvanised sheet metal. Trough of 4 cm depth. Width: 7 cm. With solid base.



Sku. 500001033 3 338020 012749

30 x 7 cm - 10 chicks

Sku. 500001050 3 338020 012756

50 x 7 cm - 20 chicks

Sku. 500001100 3 338020 035816

100 x 7 cm - 40 chicks

Limited stock



FEEDER WITH MOVABLE GRILL

Solid base. Galvanised sheet metal. Trough of 6cm depth. Width: 11 cm.



Sku. 500006050 3 338020 012817

50 cm - 6 hens

Sku. 500006075 3 338020 012824

75 cm - 10 hens

Sku. 500006100 3 338020 012831

100 cm - 15 hens



STANDARD ECONOMIC CHICK FEEDER

Standard quality feeder. A very good price to quality ratio. Dimensions: 50 x 7 cm.



Sku. 500000050 3 338020 085635

15 hens



Feeders

CIRCULAR CHICK BOTTLE HOLDER DRINKING TROUGH

Circular chick bottle holder drinking trough. Supplied with 3 adaptors for bottles.

Sku. 510004



15



AUTOMATIC CYLINDRICAL DRINKER ITALIAN MODEL

Plastic cylindrical automatic drinking trough, Italian model for poultry. Only suitable for low pressure. Delivered with 3m of hose in 12mm diameter and a pricking collar. Able to water 200-250 chickens. Spare parts available.

Sku. 510020



Tuyau 3 m Ø 12 mm



AUTOMATIC DRINKER FOR CHICKEN



This automatic drinking trough at constant level supports a pressure of up to 2 bar thanks to its very resilient valve. It is used both suspended and laid on the ground. It is also suitable for hens. Use the CHICK'A drinking trough with our antifouling disc for improved hygiene and time saving!

Sku. 510015001



1,5 L



RAPIDO DRINKER BUCKET



This drinking trough has a bucket shape, it fills up like a bucket, convenient to carry with its broad handle. Drinking trough at constant level equipped with a float. Dimension Ø 30 x H 38 cm.

Sku. 517018



18 L



POULTRY DOUBLE CYLINDER DRINKING TROUGH



Drinking trough to place on the floor. With transport handle with bayonet fixing. Advantage of the product: can be used suspended. Available in 2 capacities. The double wall makes filling easier! **Feet available**, Sku. 509006001.

Sku. 510007006

6 L - 7 hens



Sku. 510007012

12 L - 14 hens



24



PLASTIC DRINKER



The basic, essential to water your hens! Simple, practical, resilient, shape studied specifically for poultry watering.

Sku. 510005001

1,5 L - 2 hens



Sku. 510005003

3 L - 4 hens



Sku. 510005005

5 L - 6 hens



Sku. 510005010

10 L - 12 hens





—
TRIPOD PLASTIC DRINKER

24 liters tank drinking trough in galvanised steel on steel tripod. The height of the drinking trough cup allows poultry to have permanently available good quality water.

Sku. 510005030



24 L



—
PLASTIC DRINKER WITH HANDLE

Ultra-practical for moving or filling the drinking trough due to its transport handle! Ideal shape to water the poultry. This drinking trough in highly resilient plastic has slits for mounting to prevent tipping over. Available in 3 capacities.

Sku. 510006005	5 L - 6 hens		
Sku. 510006010	10 L - 12 hens		
Sku. 510006015	15 L - 18 hens		



—
TRANSPARENT RED DRINKING TROUGH

Made of red plastic. Practical and easy to clean.

Sku. 510007005



5 L



—
SUSPENDED DRINKING TROUGH WITH PIPETTE

Ideal to keep clean water, this drinking trough is equipped with 3 multidirectional pipettes. The specific shape of the drinking trough allows it to be laid on the ground when filling without damaging the pipettes. Suitable for poultry of all ages. Delivered with a suspension kit.

Sku. 509010012		
12 L - 14 hens		



Feeders

ANTIFOULING DISC



A must for your backyard hygiene! This very practical antifouling disc is used with hoppers and CHICK'A drinking troughs. It will avoid dirt water or food, and will limit the risk of bacterial contamination. Significant interest, it will save you cleaning time.



Sku. 510016



12 L - 14 hens
Limited stock

FEEDER WITH GRILL



Poultry feeding tray in plastic, metallic grill. Available in 3 sizes.



Sku. 500008050



6 hens - 50 cm

Sku. 500008075



10 hens - 75 cm

Sku. 500008005



Chicks - 50 cm

PLASTIC FEEDERS



Hoppers for the feeding of the chicks, hens and other poultry. In very resilient plastic. Very hygienic and easy to clean. The 18/20 liters feeder comes with an anti-waste grill injected in one piece onto the central tube (no risk of loss). Optimal use with the anti-fouling CHICK'A disc (Sku. 510016) for chicks up to 15 days old. 40% less loss and improved hygiene. To be placed every 5 meters.

Sku. 500015006

5 / 6 L - 6 hens



Sku. 500015010

8 / 10 L - 8 hens



Sku. 500015012

12 L - 10 hens



Sku. 500015020

18 / 20 L
13 to 15 hens



POULTRY | Vintage epoxy range

Feeders



FEEDER HOPPER USING RACK AND PINION

For a better coating! Delight in the vintage look of this feeder! Hopper with control of flow by rack and pinion. Delivered without base (Sku. 503122).

Sku. 503103  3 338020 085712

3 L - 4 hens

Sku. 503105  3 338020 085729

5 L - 6 hens

Limited stock

Sku. 503110  3 338020 085736

10 L - 8 hens

Sku. 503120  3 338020 085743

20 L - 15 hens



LIGHT GREEN RANGE



For a better coating! Natural and nuanced, this color will give a relaxing spring atmosphere to your barnyard!

Sku. 400001008  3 700393 913716

Feeder anti-pests 15 L 

Sku. 500006050008  3 700393 913747

Standard feeder 50 cm

Limited stock

Sku. 503103008  3 700393 913730

Feeder hopper using rack and pinion 3 L

Limited stock



METAL DRINKING TROUGH IN AQUA GREEN ENAMELLED SHEET METAL

Natural and subtle, this colour will give your henhouse a relaxing, springtime feel! You'll love the vintage look of this drinking trough with flap valve. Supplied without base.

Sku. 501003008 3 L  3 700393 913693

AWNING HOPPER OR DRINKING TROUGH



Single awning, in metal for rack and pinion feeder. Allows the use of enamelledhoppers outdoors Product suitable for the scattering of grain for small game.

Sku. 503111 Awning hopper or drinking trough  3 338020 087334
10 L - **Limited stock**

Drinkers



METAL DRINKING TROUGH IN GREY ENAMELLED SHEET METAL

For a better coating! You will love the vintage look of this drinking trough with filling valve.

Sku. 501003 3 L - 4 hens  3 338020 029808

Sku. 501005 5 L - 6 hens  3 338020 029815

Sku. 501010 10 L - 12 hens  3 338020 029822

Sku. 501020 20 L - 25 hens  3 338020 029839



The 1st CHICK'A range of eco-designed feeders and drinkers for an even more eco-citizen approach. Made from sugar cane and beets.



Plastic from 100% renewable resources. Natural dye.



Does not contain oil or oil derivatives.



POSITIVE CARBON FOOTPRINT.

Drinkers

GREEN LINE POULTRY DRINKING TROUGH



In plastic of superior quality. Practical. Easy to clean. Made from sugar cane and beets.

Sku. 509001001 

1,5 L

Sku. 509001003 

3,5 L

Sku. 509001005 

5,5 L



GREEN LINE POULTRY DRINKING TROUGH FOR QUAIL



In plastic of superior quality. Practical. Easy to clean. Made from sugar cane and beets.

Sku. 509007001 

1,5 L





POULTRY DOUBLE CYLINDER DRINKING TROUGH



With transport handle and feet. Double plastic wall allows a better filling! Delivered with feet. Made from sugar cane and beets.

Sku. 509006006 6 L + feet 

Sku. 509006012 12 L + feet 

Sku. 509006002 drinking through green feet x 4  



Feeders



FEEDER WITH HOPPER + GREEN LINE GRILL

Made in plastic of superior quality. Practical, easy to clean. Made from sugar cane and beets.

Sku. 509002001	1 kg	3 700393 939822
Sku. 509002002	2,5 kg	3 700393 939839
Sku. 509002004	4 kg	3 700393 939853

NEW



DOUBLE CYLINDER RECYCLED POULTRY DRINKING TROUGH



Recycled material in your poultry yard! **Made from 100 % quality recycled materials**, this double cylinder drinker is very resistant and will easily find its place in your poultry yard! Its double-walled design makes it easy to fill. Its little extra: you have a unique drinker, thanks to its design based on the recycled materials used, which will make your henhouse unique and colourful.

Sku. 510009003	3 700393 929656
-----------------------	-----------------

3 L



GREEN LINE FEEDER WITH HOPPER ANTI-PESTS

Succumb to this ultra-convenient feeder with its reserve of 12 or 20 kg. It makes life easier while taking care of your hens! Our UKAL experts have selected this feeding trough for its 4 advantages:

- Practical: The filling of the feeder is done on top with a hinged lid, moreover the pedal in plastic grill facilitates cleaning and avoids the accumulation of droppings.
- Protected: The feeder is opened by pressing the pedal, triggered by the weight of the animal. Pests (rats, mice, sparrows, etc.) cannot open it because they are too light.
- Resilient: Produced in galvanised sheet metal of quality, this feeder can remain outdoors thanks to its anti-rain system that prevents water from seeping inside.
- Rational: An anti-waste grill prevents a significant loss of food. By adjusting the sensitivity of the pedal, this feeder is suitable for all species of ducks, hens, pheasants...

Sku. 509002110	12 kg	8 718426 007580
Sku. 509002120	20 kg	8 718426 007597



Accessories



GRAIN MILL WITH BARREL



Easy to use, robust, reliable and safe, it is particularly suitable for small-scale breeding. It allows grinding and crushing of all types of cereals and dried vegetables. Grain mill with reserve barrel (50 liters). Delivered with 1 set of perforated grill diameter: 1,5 - 2,5 - 5 - 7 mm. Height 95 cm. Hourly flow: 20/40/90/170 kg.

Sku. 598100



Pigeons



PLASTIC DRINKING FOUNTAIN



The essential friend of the dovecote! Ideal shape for the pigeons. In plastic.

Sku. 710001



5.5 L



PIGEON FEEDER



A beautiful plastic feeder, easy to clean. In red and yellow colour, it will brighten your backyard. Shape specifically tailored to the pigeons. Capacity 1,5 L.

Sku. 710002



1.5 L





RING WITH CLIPS

Easy to use and reliable. 4 diameters: 8, 12, 16 and 20 mm.

Ø
8 mm



Ø
12 mm



Ø
16 mm



Ø
20 mm



Sk. 540008101 3 338020 072842

8 mm white x 100

Sk. 540008103 3 338020 072859

8 mm red x 100

Sk. 540008106 3 338020 072866

8 mm blue x 100

Sk. 540008108 3 338020 072873

8 mm green x 100

Sk. 540008110 3 338020 072880

8 mm yellow
x 100

Sk. 540008119 3 338020 072897

8 mm orange
x 100

Sk. 540008201 3 700393 919084

8 mm white x 25

Sk. 540008203 3 700393 919107

8 mm red x 25

Sk. 540008206 3 700393 919145

8 mm blue x 25

Sk. 540008208 3 700393 919268

8 mm green x 25

Sk. 540008210 3 700393 919282

8 mm yellow x 25

Sk. 540008219 3 700393 919152

8 mm orange x 25

Sk. 540012101 3 338020 072903

12 mm white
x 100

Sk. 540012103 3 338020 072910

12 mm red x 100

Sk. 540012106 3 338020 072927

12 mm blue x 100

Sk. 540012108 3 338020 072934

12 mm green
x 100

Sk. 540012110 3 338020 072941

12 mm yellow
x 100

Sk. 540012119 3 338020 072958

12 mm orange
x 100



Sk. 540008101 3 338020 072965

16 mm white
x 100

Sk. 540016103 3 338020 072972

16 mm red x 100

Sk. 540016106 3 338020 072989

16 mm blue x 100

Sk. 540016108 3 338020 072996

16 mm green
x 100

Sk. 540016110 3 338020 073009

16 mm yellow
x 100

Sk. 540016119 3 338020 073016

16 mm orange
x 100

Sk. 540016201 3 700393 919350

16 mm white x 25

Sk. 540016203 3 700393 919367

16 mm red x 25

Sk. 540016206 3 700393 919190

16 mm blue x 25

Sk. 540016208 3 700393 919404

16 mm green x 25

Sk. 540016210 3 700393 919220

16 mm yellow
x 25

Sk. 540016219 3 700393 919237

16 mm orange
x 25

Sk. 540020001 3 700393 963087

20 mm white x 50

Sk. 540020003 8 718426 005715

20 mm red x 50

Sk. 540020006 8 718426 005609

20 mm blue x 50

Sk. 540020008 3 700393 963117

20 mm green x 50

Sk. 540020010 3 700393 963124

20 mm yellow
x 50

Sk. 540020019 3 700393 963131

20 mm orange x 50

FAMILY ELECTRICAL PLUCKER

Is used for plucking chickens, hens and all similar animals. Beforehand, the animals will have to be immersed in 50-60°C water for 2 to 3 minutes. They can then be plucked by placing them on the roller equipped with rubber fingers that removes the feathers by turning. Height: 75 cm. Max 6 kg.



Sk. 560005  3 338020 078165

Family electrical plucker

Sk. 9560005001  3 700393 912597

Feet for plucker

Sk. 560005001  3 338020 078172

Fingers for plucker  



POULTRY CATCHER

Allows you to capture poultry more quickly.

Sk. 502010  3 338020 058259



PLASTIC POULTRY TRANSPORT CAGE

The perfect asset to transport your chickens! It has an upper opening thanks to a sliding door. It is also available with a side door. Dimensions: 95 x 58 cm.



Sk. 590020  3 338020 057931

Upper door

POULTRY SACRIFICE PLIERS

The subject must be suspended by the legs at a good height. Take the head in the left hand, press firmly with your thumb at the base of the skull. The beak of the poultry is then wide open. Insert the blade of the flat clamp so that it is placed in the bottom of the throat. Make a quarter turn with the clamp to bring it vertically so that the recessed part carried by the other branch of the clamp is placed on the skull, just behind the ridge, the tip of the blade must be at the bottom of the slightly inclined throat. When the clamp is in place, close it vigorously. The bleeding must be abundant, the muscles relax which allows a fast and efficient plucking.



Sk. 560001  3 338020 013784





METAL CLAMP FOR WINGS

Prevents poultry from flying away. Operating advice: Close the wing of the poultry. Clamp the feathers of the arm and forearm, without touching the flesh. Screw by tightening strongly.

Sku. 560020



By 2



PLASTIC FEEDING TUBE

For the force-feeding of geese. Plastic funnel, screw and metal. Very strong and effective.

Sku. 580020



Length 24 cm



POULTRY RESTRAINING CONE

Fixed to the wall using the support Sku. 560002002.

Sku. 560002001



Bleeder funnel

Sku. 560002002



Bracket for bleeder funnel



RABBIT KILLER

To kill small animals and especially the rabbit without suffering. Equipped with a spring pressure, it causes instant death.

Sku. 560010



Feeders and drinkers

RABBIT HOPPER WITH LID

In galvanised sheet metal. To fix on the doors of cages with bars. Height: 23 cm. Depth: 11 cm.

Sku. 600016 

1 compartment with lid

Sku. 600015 

2 compartments with lid

Sku. 600017 

3 compartments with lid



RABBIT HOPPER WITH PLASTIC LID

Automatic food distributor for rabbits. In plastic with protection against gnawing in galvanised metal. Locking mechanism. To hang in the cages. Ideal for a holiday.

Sku. 600001008 

1 compartment with plastic lid



RABBIT AUTOMATIC SOOTHER DRINKING TROUGH

Automatic water supply line at low pressure.

Sku. 610004 

By 3 



BOTTLE HOLDER DRINKING TROUGH

Delivered with stand.

Sku. 610001002 

Ovale base 

Sku. 610001003 

Rectangular base 



ALUMINIUM RABBIT DRINKING TROUGH

Allows water supply by bottle (any type of bottleneck). Very easy installation.

Sku. 610001004 

By 4 



BOTTLE HOLDER DRINKING TROUGH

Drinking trough oval base.

Sku. 610001010 

By 2  



NEW



DRINKING PIPETTE FOR RABBIT

Filling and cleaning facilitated through an opening placed at the top. Robust pipette ensuring drop after drop for a good provision of drinking water.

Sku. 610003200 

1 L  



PLASTIC RABBIT DRINKING TROUGH

Drinking trough in resilient plastic. Easy filling from the top. Teat at 90°. Teat anti-drip mechanism. Fits easily on all types of cages. Capacity 1L.

Sku. 615100008 



1 L  













AUTOMATIC RABBIT DRINKING TROUGH

A utomatic water supply at low pressure. Fixation by plate Delivered in sets of 2.

Sku. 610040	
By 2	

PLASTIC HOSE & JUNCTION

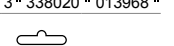

Sku. 610041	
Straight connector x 5	
Sku. 610042	
L connector x 5	
Sku. 610043	
T connector x 5	
Sku. 610044	
X connector x 5	

PLASTIC FEEDING TROUGH

Plastic, with heavy base to improve stability.



Sku. 710010	
Double rectangular plastic feeding trough 750 ml	
Sku. 710020	
Single rectangular plastic feeding trough 500 ml	
Sku. 710030	
Round plastic feeding trough 500 ml	





UKAL

— HORSES

- 162 Coat care
- 162 Halters
- 164 Lead ropes
- 165 Grooming
- 169 Fly-masks
- 170 Pads and sheets
- 171 Blankets
- 172 Hoof care
- 174 Horse shoeing
- 174 Horse feed
- 175 Leather care



HORSES | Coat care and halters

Mane, coat and tail care



HAIR TONIC



Acts on dandruff, itching and friction. This highly effective tonic lotion rids the tail of dandruff, reduces itching and promotes the growth of long, healthy, beautiful hair, thanks to the caffeine, which stimulates hair growth from the root. The burdock root oil stops the spread of bacteria that cause eczema and dry patches. The tonic can also be used preventively to keep the scalp healthy.

Sku. 130E715006  4 033081 050370
250 ml 



DETANGLER

For instant detangling of the mane and tail. The natural lemon active ingredients give the hair a silky gloss, making it easy to brush the mane and tail.

Sku. 130E715004  4 033081 050646
1 L 



MANE BANDS

Box of HIPPOTONIC mane bands. Contains 500.

Sku. 130E306776001  3 338025 277563
 White 
Sku. 130E306776002  3 338025 277570
 Black 

SPRAY FOR A SHINY COAT, TAIL AND MANE

A revolutionary combined product to take care of your horses. It produces a coat which is as soft as silk and gives a long-lasting shine to the coat, tail and mane. The fine, glossy effect lasts for at least 12 days, and tail and mane remain tangle-free for the same length of time. EQUISTAR is absolutely non-toxic, even for very sensitive horses. For the time during which it is effective, it is dust- and dirt-repellent and water-repellent, and prevents the formation of new clusters of flies' eggs. EQUISTAR makes it easy to brush off spots of urine, dirt or dung, with just a few brush strokes.



Sku. 130E705706  4 250081 140010
750 ml 







Halters









SOFT SYNTHETIC SHEEPSKIN HEADCOLLAR

Made from double-thickness polypropylene, lined with beige synthetic sheepskin and featuring adjustable headpiece and noseband with buckles. Quick-release throat latch with snap. Metal buckles.

Thoroughbred

Sku. 130E510014202  3 338025 620567
 Black 
Sku. 130E510014203  3 338025 620574
 Red **Limited stock** 
Sku. 130E510014207  3 338025 620581
 Navy **Limited stock** 

Horse





Sku. 130E510014302  3 338025 620635
 Black **Limited stock** 
Sku. 130E510014307  3 338025 620659
 Navy **Limited stock** 
Sku. 130E510014311  3 338025 620666
 Dark grey **Limited stock** 









POLYPROPYLENE HALTER

Double-ply polypropylene halter with buckle-adjustable headpiece and noseband. Brass-coloured fastenings.

Thoroughbred

Sku. 130E510031002  3 338025 159623
 Black 
Sku. 130E510031003  3 338025 159630
 Red 
Sku. 130E510031007  3 338025 159654
 Navy 

Horse

Sku. 130E510032002  3 338025 159685
 Black 
Sku. 130E510032003  3 338025 159692
 Red 
Sku. 130E510032007  3 338025 159715
 Navy 





"CLUB" HEADCOLLAR AND LEAD ROPE SET

Made of polypropylene, with silver-coloured metal buckles. Adjustment buckles on headpiece and noseband. Quick-release throat latch with snap. Lead rope approx. 2,20 m long.



Sku. 130E510118302 3 338025 557153

Black

Sku. 130E510118303 3 338025 557160

Red

Sku. 130E510118307 3 338025 557184

Navy

ETHOLOGICAL HALTER WITH REINS

Pre-knotted polypropylene ethological halter featuring 2 chrome-plated stainless steel rings on the noseband to attach the reins. Sold with a pair of removable reins (overall length 3 m) with swivel trigger snaps made of chrome-plated zinc.



Sku. 130E510155002 3 338025 449052

Black

Sku. 130E510155004 3 338025 496681

Brown

LEATHER-LINED NYLON HEADCOLLAR

Two-tone triple-layer nylon halter with adjustable noseband and headpiece and lined with black buffalo crust leather. Yellow metal buckles.

Pony

Sku. 130E510180002 3 338025 006965

Black

Draught horse

Sku. 130E510192002 3 338025 078917

Black

Thoroughbred

Sku. 130E510185002 3 338025 007016

Black

Sku. 130E510185004 3 338025 007030

Brown

Sku. 130E510185007 3 338025 146937

Navy

Horse

Sku. 130E510190002 3 338025 007061

Black

Sku. 130E510190004 3 338025 007085

Brown

Sku. 130E510190007 3 338025 146968

Navy



HORSES | Lead ropes

Lead ropes

TIE ROPE

NORTON

Soft polypropylene rope with swivelling snap hook made from brass-plated steel. Length: 2 m approx.



Sku. 130E520000002  3 338025 385145

 Black 

Sku. 130E520000003  3 338025 244381

 Red 

Sku. 130E520000004  3 338025 244459

 Brown 

Sku. 130E520000007  3 338025 244398

 Navy 

TIE ROPE WITH SAFETY CLIP

NORTON

Polypropylene tie rope. Zinc panic snap. Length: 2 m.



Sku. 130E520015002  3 338025 549516

 Black 



Sku. 130E520015007  3 338025 549547

 Navy 

FOX-RESISTANT LEAD ROPE WITH SPRING

NORTON

With a panic snap to attach to the halter and a fireman snap for the attachment ring. Spiral-shaped polyurethane-coated steel cable enabling the shortest possible lead with no loose dangling rope, ideal for transport. Spiral cable, can be stretched from 30 to 150 cm.



Sku. 130E520080006  3 338025 486217

 Navy 

AMERICAN LEAD ROPE

NORTON

The American lead rope attaches to the halter. Durable, tightly braided and easy to handle. Approx. 2,50 m long. Swivelling yellow brass snap hook.

Sku. 130E520069002  3 338025 249157

 Black 

Sku. 130E520069007  3 338025 249164

 Navy 



Swedish brushes

NATURAL COUCH GRASS DANDY BRUSH



Natural couch grass is naturally wavy, and though the bristles are hard, they make for efficient brushing and do not prick horses' skin. Beech wood back. Small model.

Sku. 130E700107



Natural
Limited stock



NEW

NATURAL DANDY BRUSH SMALL MODEL



The Hippo-Tonic natural brush combines the soft Tampico fibre with the hard Palmira fibre. Very pleasant for the horse and very effective, this brush allows efficient brushing thanks to its mixed bristles and does not sting the horses' skin. Used after the currycombing, the Hippo-Tonic natural brush removes dust and dirt from the coat and is passed over the whole horse. The Hippo-Tonic natural brush has a beech wood back.

Sku. 130E700107000



Natural



"SOFT" DANDY BRUSH



Dandy brush with a leather-effect polyurethane back, foam-padded with soft-feel reinforcements on the edges. Two-coloured 5.5 cm polypropylene bristles.

Small model

Sku. 130E700683006



Royal blue



Sku. 130E700683032



Fuchsia



Large model

Sku. 130E700682002



Black



Sku. 130E700682006



Royal blue



Sku. 130E700682007



Navy



Sku. 130E700682032



Fuchsia



SWEDISH DANDY BRUSH



Chic and elegant, with its beech wood back, the HippoTonic Swedish dandy brush is made in France. It allows quick, efficient grooming by removing deep-lying dirt and dust thanks to its 65 mm- long PET bristles. Its ergonomic shuttle shape means it fits perfectly in the hand.

Sku. 130E700588003



Red
Limited stock



Sku. 130E700588006



Blue
Limited stock



NEW

Sku. 130E700604026



Caramel



Sku. 130E700604004



Brown



"TORSE" NYLON DANDY BRUSH



Made in France, the HippoTonic Torse dandy brush is an essential addition to your grooming kit! Premium quality, with a sophisticated look, this Nylon Dandy Brush is designed with a very elegant and sturdy varnished beech wood back. The 40 mm-long polypropylene bristles are conducive to deep cleaning. Thanks to its shuttle shape, this dandy brush is very practical and allows an excellent grip, for optimum grooming.

Sku. 130E700590003



Red
Limited stock



Sku. 130E700590006



Blue
Limited stock





Brushes



MULTI-PURPOSE BRUSH

Can be used as a dandy brush, as a hoof brush, to shampoo your horse or even to remove hairs from a saddle pad.

Sku. 130E700120002  3 338025 529891

 Black 

Sku. 130E700120003  3 338025 529907

 Red 

Sku. 130E700120006  3 338025 529921

 Royal blue 

Sku. 130E700120007  3 338025 529938

 Navy 



"SOFT" BODY BRUSH

Brush with a leather-effect polyurethane back, foam-padded, with soft-feel reinforcements on the edges. Two-coloured 3,9 cm polypropylene bristles and polypropylene strap.

Small model

Sku. 130E700681006  3 338025 631495

 Royal blue 

Sku. 130E700681032  3 338025 631457

 Fuchsia 

Large model

Sku. 130E700680002  3 338025 631426

 Black 

Sku. 130E700680006  3 338025 631402

 Royal blue 

Sku. 130E700680007  3 338025 631419

 Navy 

Sku. 130E700680032  3 338025 631385

 Fuchsia 



"SOFT" HEAD BRUSH

Head brush with foam-padded leather-effect polyurethane back with soft-feel reinforcements on the edges. Two-coloured 4.1 cm polypropylene bristles.

Sku. 130E700684002  3 338025 631785

 Black 

Sku. 130E700684006  3 338025 631761

 Royal blue 

Sku. 130E700684007  3 338025 631778

 Navy 

Sku. 130E700684032  3 338025 631723

 Fuchsia 



"SOFT" MANE BRUSH

The brush that untangles gently and efficiently. The foam-padded handle made from leather-effect polyurethane is pleasant to handle. The highly flexible and durable bristles enable perfect brushing without breaking any hairs, even when knots are present.

Sku. 130E700685002  3 338025 631891

 Black 

Sku. 130E700685006  3 338025 631877

 Royal blue 

Sku. 130E700685007  3 338025 631884

 Navy 

Sku. 130E700685032  3 338025 631839

 Fuchsia 





Curry combs

ROUND METALLIC CURRY COMB

Round metallic curry comb (American-style) with reversible blades. 2 tooth heights to adapt to the sensitivity of your horse. Does not get dirty.



Sku. 130E700029  3 338025 068864



 Red  

OVAL RUBBER CURRY COMB



Used on the fleshy parts of your horse at the beginning of grooming, it separates stuck-together hair and effectively removes dust. Hollow curry comb made of natural rubber.



Sku. 130E700062003  3 338025 623049

 Red  

Sku. 130E700062006  3 338025 623056

 Royal blue  

OVAL RUBBER CURRY COMB

Hollow curry comb made of natural rubber.



Sku. 130E700076002  3 338025 622967



 Black  

CURRYING GLOVE AND BRUSH

Made of natural rubber, with small and large pimples to separate the hair, stimulate blood flow and remove any dead hairs.



Sku. 130E700137007  3 338025 623070

 Navy  



ANTI-MOULT GROOMING GLOVE



Thanks to its innovative design, this glove easily removes loose hair and allows care in hard-to-reach areas, such as the head and legs. Rubber pimples on the palm of the hand provide a gentle and relaxing massage and can help improve the animal's circulation. The hook-and-loop wrist strap and the elastic fabric sewn onto the back of the hand make it easy to put on and take off the gloves. Composition: 100 % PVC. Sold by the pair.



Sku. 130E700162002  3 338025 629843



 Black  

DOUBLE-SIDED CURRYING/ MASSAGE GLOVE



Dual-function PVC glove. One side is a curry comb with pimples, while the other features 7 stainless steel ball bearings. Helps warm up your horse's muscles before workouts and relax them after.





Sku. 130E700147002  3 338025 634915

 Black  



Sku. 130E700147006  3 338025 445245

 Royal blue  

Sku. 130E700147013  3 338025 634892

 Pink  

Sku. 130E700147015  3 338025 445252

 Purple  

Comb



"JOCKEY" ALUMINIUM MANE COMB

To thin the mane and untangle and plait the hair.

Sku. 130E700051



"Jockey" comb



Accessories



"GRIP" FOLDING STEP STOOL

In polypropylene with non-slip rubber pimples. Your stability and your feet feel safer on this step stool that can also be used as a mounting block. Easy to carry thanks to its integrated handle, and can be easily stored away behind a cabinet or inside your locker. Features non-slip rubber legs. Dimensions: L 28,5 x W 21,5 x H 39 cm.

Sku. 130E930251



Strength: 100 kg



Grooming boxes



GROOMING BOX

The two-coloured HippoTonic grooming box has a removable central unit for small equipment and a removable brush holder that can be affixed to the inside of the box. Lightweight and reasonably sized, it is ideal for storing all your grooming accessories. Compatible with tack trolley Ref. 130E704229. The two-coloured HippoTonic grooming box has a reinforced lid and can withstand a weight of up to 100 kg: ideal as an extra mounting block, stool or stepladder for thorough grooming! Accessories not included.



Sku. 130E70004211



Black/Grey



Sku. 130E70005357



Raspberry/Navy



Sponge

RECTANGULAR SPONGE

Synthetic sponge. Size: L 16 x W 7,5 x H 4 cm.



Sku. 130E700188



Yellow



Stablemate



STABLEMATE

Hippo-Tonic Stable Manure Shovel + rake ideal for partial box or stable cleaning and the collection of manure in the riding area. Shovel and rake with telescopic handle, adjustable in height by means of a knob.



Sku. 130E704140002



Shovel + rake



Sweat scrapers

CURVED SWEAT SCRAPER

Flexible rubber scraper for gentle efficiency. Ergonomic handle. Made of PVC. Double-sided blade: rubber 50 mm / plastic 5 mm.

Sku. 130E700172003	
Red	
Sku. 130E700172006	
Navy	
Sku. 130E700172011	
Grey	



"SOFT" SWEAT



Sweat scraper with leather-effect polyurethane handle, padded with foam.

Sku. 130E700687002	
Black	
Sku. 130E700687006	
Royal blue	
Sku. 130E700687007	
Navy	
Sku. 130E700687032	
Fuchsia	



Fly-masks

NEW



"CONFORT" FLY MASK

Light, hard-wearing fly mask providing complete protection thanks to the built-in nostril protector. Mesh fabric on the ears and cheeks for greater comfort. Fleece-lined edges. Headpiece lined with synthetic sheepskin. Quick and easy to fit thanks to a self-gripping tape and a forelock loop. Anti-UV protection.

Black	
Sku. 130E306008201	
Pony	
Sku. 130E306008202	
Thoroughbred	
Sku. 130E306008203	
Horse	











NEW



"SUPERCUT" FLY MASK

Light fly mask with fleece edges and synthetic sheepskin at forehead. Very soft mesh fabric around the ears. Excellent hold thanks to 2 self-gripping tapes and forelock allowance. Anti-UV protection. Composition: Polyester/PVC.

Black	
Sku. 130E306010201	
Pony	
Sku. 130E306010202	
Thoroughbred	
Sku. 130E306010203	
Horse	
Sku. 130E306010204	
Draught	



HORSES | Pads and sheets

Saddle pads



"ROPE" SADDLE PAD



Polyester saddle pad with 15 mm foam padding. With strap loop. Polyester mesh lining. Attractive shiny edging.

Sku. 130E204535002		3 338025 660839
Black		20
Sku. 130E204535007		3 338025 660853
Navy		20

Pads



BACK PAD



Polyester back pad with diamond stitching. 14 mm polyester foam interior, entirely covered with synthetic sheepskin. Slight gap around the spine. Machine-washable (wool cycle). Do not tumble-dry.

Sku. 130E206065002		3 338025 571272
Black		20
Sku. 130E204535007		3 338025 571302
Navy		20

Sheets



"COMBO" MESH SHEET



Full-body protection from insects! Quick-drying, breathable honeycomb mesh sheet made of densely woven flexible 120 g/m² polyester. Comes with a neck cover combo with 3 hook-and-loop flaps and elastic attachment lug on the front to hold it firmly in place. Sheet with deep comfort gusset, elasticated belly flap, chrome-plated male/female buckle fastening on the chest made with hook-and-loop straps, leg straps mounted on elastic, and a long coverall tail flap. Machine-washable at 30° C. Do not tumble-dry.

White/Sky blue

Sku. 130E400000159		3 338025 583497
Size: 5'9		8
Sku. 130E400000160		3 338025 583503
Size: 6'0		8

Sku. 130E400000163		3 338025 583510
Size: 6'3		8
Sku. 130E400000169		3 338025 583534
Size: 6'9		8



POLAR FLEECE SHEET



A tried-and-tested basic: a drying sheet or under-sheet made of 100 % polyester polar fleece (thickness 240 g/m²). Anti-friction fleece withers pad. Nickel-plated metal buckle chest fastener and tail strap. Machine-washable at 40° C. Do not tumble-dry.

Black/Grey

Sku. 130E400636259		3 338025 594608
Size: 5'9		10
Sku. 130E400636260		3 338025 594615
Size: 6'0		10

Sku. 130E400636263		3 338025 594622
Size: 6'3		10
Sku. 130E400636269		3 338025 594646
Size: 6'9		10



POLAR FLEECE EXERCISE SHEET



Absorbent, quick-drying, lint-free 100 % polyester polar fleece fibre. Thickness 220/240 g/m². Decorative edging. With saddle hole, hook-and-loop fastening on the withers and tail strap. Machine-washable at 30° C. Do not tumble-dry.

Black/Grey

Sku. 130E400154225		3 338025 594486
Size: 125 cm		15
Sku. 130E400154240		3 338025 594493
Size: 140 cm		15
Sku. 130E400154250		3 338025 594509
Size: 150 cm		12

Blankets

STABLE RUG



Unbeatable value for money! Pleated stable rug made of 420-denier polyester lined with anti-friction and antistatic polyester. 300 g/m² polyfill padding. Fleece protection for the withers. Double chest closure with buckles and straps, low crossover surcingles and tail strap. Machine-washable at 30° C. Do not tumble-dry.

 Navy/Sky blue

Sku. 130E400505759 

Size: 5'9 

Sku. 130E400505760 

Size: 6'0 

Sku. 130E400505763 

Size: 6'3 

Sku. 130E400505769 

Size: 6'9 



"OXFORD" WATERPROOF BLANKET



Waterproof blanket made of 300D Matty polyester with polycotton lining. With gussets, synthetic sheepskin withers pad, elasticated low crossover surcingles, adjustable and removable snap-hook leg straps, a tail strap and a waterproof tail flap. Adjustable buckle chest fastening with hook-and-loop flap. Metal buckles.



 Black

Sku. 130E400892259 

Size: 5'9 

Sku. 130E400892260 

Size: 6'0 

Sku. 130E400892263 

Size: 6'3 

Sku. 130E400892269 

Size: 6'9 

"OXFORD" WATERPROOF BLANKET LINED WITH POLAR FLEECE



Waterproof blanket made of 300D Matty polyester, with polar fleece lining. With gussets, synthetic sheepskin withers pad, elasticated low crossover surcingles, adjustable and removable snap-hook leg straps, a tail strap and a waterproof tail flap. Adjustable buckle chest fastening with hook-and-loop flap. Metal buckles.



 Black

Sku. 130E400894259 

Size: 5'9 

Sku. 130E400894260 

Size: 6'0 

Sku. 130E400894263 

Size: 6'3 

Sku. 130E400894269 

Size: 6'9 

HORSES | Hoof care

Tendon & fetlock boots



TENDON BOOTS



One of the best value-for-money products on the market, if not the best! These tendon protectors have a soft moulded plastic shell lined with 3 mm-thick neoprene. Two wide double-sided hook-and-loop closure straps mounted on a double thickness of elastic, coupled with a flap bearing the Riding World logo. Neoprene. Sold in pairs.

Sku. 130E530102002		3 338025 584401	
	Black		25
Sku. 130E530102007		3 338025 584760	
	Navy		25



FETLOCK BOOTS



One of the best value-for-money products on the market, if not the best! These fetlock protectors have a soft moulded plastic shell lined with 3 mm-thick neoprene. Two wide double-sided hook-and-loop closure straps mounted on a double thickness of elastic, coupled with a flap bearing the Riding World logo. Neoprene. Sold in pairs.

Sku. 130E530105002		3 338025 584463	
	Black		25
Sku. 130E530105007		3 338025 584791	
	Navy		25

Bandage



DOUBLE-SIDED POLO BANDAGES



Double-sided polo bandages made of polar fleece fibres: 260 g/m². Width: 11 cm. Closed with a wide hook-and-loop strap: 50 mm.



Sku. 130E540070002		3 338025 631327	
	Black	Limited stock	25
Sku. 130E540070007		3 338025 631341	
	Navy	Limited stock	25

Hoof pick



"SOFT" HOOF PICK



For a better grip. Ultra-practical for removing all dirt, the bristles of the brush are made of polypropylene. Hoof pick with foam-padded leather-effect polyurethane handle.

Sku. 130E700686002		3 338025 631983	
	Black		200
Sku. 130E700686006		3 338025 631969	
	Royal blue		200
Sku. 130E700686007		3 338025 631976	
	Navy		200
Sku. 130E700686032		3 338025 631921	
	Fuchsia		200

Brushes



HOOF OIL BRUSH WITH CAP

Plastic handle and genuine white pig bristles, with storage cap.

Sku. 130E700528002		3 338025 288293	
	Black		100

HOOF OIL BRUSH WITH CONTAINER

Small oil container with screw cap and integrated PVC oil brush. Polypropylene bristles. Capacity: 125 ml.



Sku. 130E700529002		3 338025 192842	
	Black		50
Sku. 130E700529003		3 338025 509398	
	Red		100
Sku. 130E700529008		3 338025 509411	
	Green		100

Hoof care

HOOF OIL + BRUSH



Liquid version of EFFOL® hoof ointment. Contains bay oil and vaseline. Strengthens the hoof, promotes its natural development and ensures healthy growth. Regular application protects against cracking and hoof diseases and promotes elasticity. To be applied with the brush, having carefully cleaned the hoof beforehand.



Sku. 130E700265



475 ml



HOOF OINTMENT



Made with bay oil. Strengthens the hooves. Revitalizes the hooves and makes them more supple. Prevents cracking and hoof disease. To be applied with a soft brush, focusing on the coronary band. 1 L.



Sku. 130E700203



Black



Sku. 130E700205



Green



HOOF OINTMENT



Made of Vaseline and real bay oil. For hoof care and protection. Prevents drying out and excessive softening. Makes the hoof supple and stronger. Contains high-quality oils, bay oil, bay leaf oil and lanolin. 1 L.



Sku. 130E707105002



Black



Sku. 130E707105008



Green



HOOF BALM



Protect and care for your horse's hooves, with natural eucalyptus and bay oil. New recipe which liquefies when it comes into contact with the hoof, allowing the ingredients to seep deeply into the hoof capillaries. Regenerates brittle or crumbling horn and strengthens the hoof. Gives the hoof a lasting shine - cares for, nourishes and strengthens the horn. Remains malleable at temperatures from +2° to +40°, without melting. Recipe does not contain mineral oil.



Sku. 130E715000



12 ml



HOOF OIL WITH BRUSH



For healthy hooves. Pure avocado, jojoba, sesame and calendula oils nourish and care for the hooves, preserving their elasticity and health. The hoof oil stimulates the growth of the hooves, improves their structure, protects against rotting and gives them a lasting shine.



Sku. 130E715001



450 ml



Tar

HOOF TAR



Antiseptic formula to protect and care for the hooves. To be applied directly to the area to be treated. 100 % beech tar.

Sku. 130E797141



500 g



Horse shoeing



FLAT HOOF RASP KAMER

Double-sided (fine and coarse). With handle.

Sku. 106621



L 35 cm



SHARPENED HOOF SCRAPER

Made of black lacquered steel. Removes horn to prepare the hoof for fitting the horse shoe. Handle with hole for shock absorption.

Sku. 106625



L 30 cm



PROFESSIONAL HOOF TRIMMER

Jaws open wide.

Sku. 106601001



L 35 cm



Horse feed



TREATS FOR HORSES



Supplementary feed for horses. Feeding instructions: give each animal up to 200 g per day. Store in a cool, dry place, away from direct sunlight.

Sku. 130E713000 Apple flavour - 1 kg



Sku. 130E713001 Carrot flavour - 1 kg



Sku. 130E713002 Banana flavour - 1 kg



Sku. 130E713005 Coconut flavour - 1 kg



HIMALAYAN SALT BLOCK



A totally natural salt lick, extracted from Himalayan rocks. Very pure and with a specific and highly palatable taste, the Himalayan salt block is rich in minerals and trace elements, and brings your horse vitality and well-being. This block is very solid as it is made from a single piece of rock. It does not break or dissolve when in contact with moisture like compressed salt blocks do, so it can be used in pastures. The salt block is pierced and can be placed in a manger, on a salt block holder or fixed anywhere with the supplied rope. Composition: sodium chloride 98,62 %, magnesium 0,40 %, calcium 0,11 %, sulphates 0,10 %, iron 0,001 %, moisture content 0,03 %, non-soluble residue 0,73%.

Sku. 130100

3 kg



Leather care

LEATHER SOAP



A glycerine-based soap to clean, maintain and grease leather saddles and bridlery. With sponge. Regulation (EC) No. 648/2004. Composition: at least 5 % but less than 15% soap; scents, limonene, benzyl alcohol, benzyl benzoate, benzisothiazolinone, sodium pyrrhione.

Sku. 130E707010



250 ml



GLYCERINE SOAP



Cleans all smooth leathers quickly, gently and deeply. Gets rid of stubborn dirt, dust residue and sweat with ease. The active ingredients penetrate deep into the leather and soften it. Cares for leather and gives it a fresh shine. Treat with EFFAX® leather balm (ref. 700 250) or EFFAX® leather oil (ref. 700 263) afterwards if the leather is dry and under great strain.

Sku. 130E700218



300 ml



LEATHER BALM



Made from beeswax, it nourishes the leather and makes it waterproof, soft, supple and durable. Contains essential leather nourishing products. Contains high-quality oils, Vaseline, beeswax, scent. Colourless.

Sku. 130E707040



500 ml



LEATHER BALM

Deep nourishment, care and protection for your leather, without damaging the seams. The leather remains supple and tear-resistant. Contains lanolin, avocado oil and beeswax for reliable, long-lasting leather. The beeswax has water-repellent qualities and makes the leather shine. Suitable for all smooth leathers. Colourless.

Sku. 130E700250



500 ml



LEATHER LOTION MADE FROM REAL NEATSFOOT OIL

Special oil for maintaining all leathers, particularly saddlery, bridlery, harnesses and leather sports balls. Contains high-quality oils, neatsfoot oil and scent.

Sku. 130E707075



500 ml



RAPID LEATHER CARE



Two-in-one saddle soap and leather grease. Cleans and maintains all kinds of leather. Greases, protects and maintains leather and gives it a beautiful natural shine.

Sku. 130E715009



250 ml



PUNCH PLIERS

Very robust punch pliers. Sold with a hole size indicator under a window.

Sku. 130E700423

Red metal





UKAL

—
PET WELL-BEING

- 178 Nutravital Probiotics
- 179 Pet+Me brushes
- 180 Puralia shampoos

NUTRAVITAL, probiotics and prebiotics care for your pets



Packaging only for french and german market .
Please check regulations in your country before importation.
Do not hesitate to contact us for more information.





Pet+ME brushes

NEW



BRUSH FIRM SILICONE

No matter if it's a dog or a cat. With long or short hair, the pet+me® brush will pamper and comfort your furry friend in several ways. This cleaning and massage brush will deliver a balanced combination of efficiency and comfort. These brushes are soft and gentle even on the most sensitive skin and are most effective in removing loose hair, sebum, and dandruff. The pet+me® brush is made of 100% pure silicone, **safe for both humans and animals**. For a thorough cleaning, they can be washed in the washing machine. The pet+me® brush is the perfect lint brush! It acts like a magnet with a static cling effect. It may be used dry or wet. Using the fine side with pressure applied, even the finest of hair, dust, and allergens can be wiped away. Use it on upholstery, carpets, clothing, and car seats. Routine brushing of the animal, about twice a week, can help in reducing otherwise airborne dust and allergens.



Sku. 805050100	Red - Large breed dogs			
Sku. 805050200	Blue - Dogs and cats with short hair			
Sku. 805050300	Yellow - Dogs, most short hair types			
Sku. 805050400	Green - Dogs and cats with long hair			

puralia

FOR A HEALTHY COAT



PUPPY
SHAMPOO

HYPO-ALLERGENIC
SHAMPOO

ALL-ROUND
SHAMPOO

TESTED FORMULAS

We have selected Oats as a cross-cutting active ingredient to the whole range for its nutritional qualities

In addition to the cross-cutting **skincare** : active ingredient: Oats, we have selected a unique **well-being** active ingredient for each of our formulations.



Tested and approved
by groomers



Cleans • Soothes
Moisturises • Protects

Natural well-being care for dogs

NEW RANGE

Enhance your dog's coat with the Puralia range. A perfect combination of two active ingredients for the **care** and **well-being** of your pet during grooming.



REPAIR SHAMPOO

CONDITIONING SHAMPOO AND SPRAY

ECO-FRIENDLY FORMULATIONS



Vegan



No parabens



No silicon



No colouring

Min 95%
NATURAL INGREDIENTS



NEW

puralia

ALL-ROUND SHAMPOO

Treat your dog to a moment of relaxation and well-being with our specially designed all-round shampoo. The formula, made from **oatmeal and aloe vera, with ultra-moisturising properties creates a real feeling** of comfort and softness when grooming. Its delicate perfume leaves your companion's coat with a pleasant scent. It is suitable for all types of dog. Made in France.



Sku. 805900501 

250 ml

Sku. 805900502 

1 L



NEW

puralia

PUPPY SHAMPOO

Treat your puppy to a moment of relaxation and well-being with our specially designed shampoo. Our unique, **non-irritating formula** deeply cleans the coat while respecting the skin's natural balance. This shampoo combines **oatmeal and cotton**, which are known for their soothing, **nourishing properties**, to care for your puppy's delicate coat. It creates a real feeling of comfort and softness when grooming. Its delicate perfume leaves your companion's coat with a pleasant scent. Made in France.



Sku. 805900101 

250 ml

Sku. 805900102 

1 L



NEW

puralia

REPAIR SHAMPOO

Treat your dog to a moment of relaxation and well-being with our specially designed repair shampoo. This shampoo combines **oatmeal with ginseng**, which help to restore shine and strengthen the coat. Ginseng is known for its **revitalising, antioxidant properties**, which care for the coat while restoring its elasticity. The formula deeply **repairs and nourishes the coat**, helping to stimulate growth while respecting the skin's natural balance. Its delicate perfume leaves your companion's coat with a pleasant scent. Made in France.



Sku. 805900201 

250 ml

Sku. 805900202 

1 L



NEW

puralia

HYPO-ALLERGENIC SHAMPOO

Treat your dog to a moment of relaxation and well-being with our specially designed hypo-allergenic shampoo. Our unique **hypo-allergenic** formula is recommended for sensitive skin. It deeply cleans the coat while respecting the skin's natural balance. This shampoo combines **oatmeal and marigold**, which are known for their soothing, **moisturising properties**. Marigold has regenerative properties which help with irritation and creates a real feeling of comfort and softness when grooming. Its delicate perfume leaves your companion's coat with a pleasant scent. Made in France.



Sku. 805900301 

250 ml

Sku. 805900302 

1 L

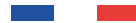

NEW

puralia



CONDITIONING SPRAY

Treat your dog to a moment of relaxation and well-being when grooming with this leave-in conditioning spray. The combination of oatmeal and wheat conditions and revitalises the coat. It creates a real feeling of comfort when grooming. It restores shine to the coat. Its delicate perfume leaves your companion's coat with a pleasant scent. Made in France.

Sku. 805900404 150 ml 

NEW

puralia



CONDITIONING SHAMPOO

Treat your dog to a moment of relaxation and well-being with our specially designed conditioning shampoo. The **oatmeal and wheat-based formula** conditions your dog's **coat while** respecting the skin's natural balance. Wheat has **nourishing properties** and helps the coat to remain strong. This conditioning shampoo helps to revitalise the coat and restores its **shine**. Its delicate perfume leaves your companion's coat with a pleasant scent. Made in France.

Sku. 805900401 250 ml 

Sku. 805900402 1 L 

CLIPPERS

at the cutting edge of precision



→ Go to page 90 to discover the range of finishing clippers for pets.



UKAL

—
PEST CONTROL

- 186 Klaktrap
- 190 Swissinno
- 194 Traps for licensed trappers
- 196 Boxtrap



*UKAL's own brand since 2010,
KLAKTRAP stands out for its wide
selection of metal traps for animals and
in particular traps for mice and rats.
Efficient and easy to use.*



Mice

ROUND WOODEN MOUSE TRAP 12 CM

Ideal cage trap to catch mice with bait. Very easy to use, simply open the hatch and place the bait on the bait holder and place the trap in an area where mice are present. The mouse is attracted to the bait and enters the trap cage, which closes behind it. The mouse is trapped alive, and you can release it elsewhere. The trap's wooden base ensures optimum rigidity and reassures the animal!



Sku. 129800001



L 12 x W 5,5 x H 6 cm



MOUSE TRAP 23 CM

This mouse trap is easy to use. Simply place some bait in the back of the cage, which is accessible through a door. You can then place your trap in the desired location and wait for the mice to fall into the trap. This 23 cm trap is large enough to capture one or more live mice at the same time. No poison is involved, so it is safe for children and pets and can be used anywhere in the house, garage, attic or any other location. The bars of the trap are made of galvanized steel, to ensure a long service life.



Sku. 129800



L 23 x W 15 x H 12 cm



RECTANGULAR MOUSE TRAP 23 CM

Multi-catch cage mouse trap. Easy to use. Simply place some bait in the back of the cage, which is accessible through a door. You can then place your trap in the desired location and wait for the mice to fall into the trap. The bars of the trap are made of galvanized steel, to ensure a long service life.



Sku. 129800002



L 23 x 14 x H 10,5 cm
Limited stock

WIRE TRAP

Wire trap Ø 13 cm or 17 cm, ideal to capture mice or rats. Very easy to use. Simply place bait on the trigger and open the wire trap to set it. Once set, it should be circular in shape. When the animal takes the bait, the trap closes to capture it.



Sku. 129701113



13 cm
Limited stock



Sku. 129701117



17 cm
Limited stock



Rats

RAT TRAP WITH WOODEN BASE 28 CM



Ideal cage rat trap for use with bait. Very easy to use. Simply open the hatch of the trap, place some bait inside and place the trap in an area where rats are present. The rat, lured by the bait, enters the cage and it closes behind it. It will be trapped alive. You can then release it elsewhere. The trap's wooden base ensures optimum rigidity and reassures the animal! Also works with mice.



Sku. 129806001



28 cm



RECTANGULAR RAT TRAP 41CM



This trap is ideal for capturing multiple rats. Easy to use, simply place a bait in the bottom of the net, accessible through a door. You can then place your trap in the desired location and wait for the rats to get caught. The wires of the trap are made of galvanised steel.



Sku. 129806003



41 cm



RAT TRAP 40 CM



This cage rat trap is ideal for capturing more than one rodent (rats and others) at a time. Easy to use. Simply place some bait in the back of the cage, which is accessible through a door. You can then place your trap in the desired location and wait for the mice to fall into the trap. This 40 cm trap is large enough to capture one or more live rats at the same time. No poison is involved, so it is safe for children and pets and can be used anywhere in the house, garage, attic or any other location. The bars of the trap are made of galvanised steel, to ensure a long service life.



Sku. 129806



40 cm



PALLET TRAP FOR RAT



Pallet trap for rats, ideal for catching rats, dormice, louse and other pests indoor buildings or in closed properties. It is the ideal solution to ensure successful shots!



Sku. 129700001



Moles



WATCH A VIDEO
PRESENTATION OF
THE HAND MOLE TRAP



PUTANGE MOLE TRAP



The Putange mole trap has been used by professional mole trappers for decades. It is effective and kills the animal instantly. Choosing the Putange mole trap means choosing a durable, economical and ecological solution. 2 traps must be installed in each tunnel, one in each direction.

Sku. 129710010	Pack of 2			84
Sku. 129710012	1 pair of setting pliers			35
Sku. 129710013	Triggers in packs of 10			150



WATCH A VIDEO
PRESENTATION OF
THE HAND MOLE TRAP



HAND MOLE TRAP



This trap is set by hand and can be reused ad infinitum as long as you have a trigger to hold the trap open and ready. This trap is used without a setting device. When the mole pushes against the trigger (a small metal frame that holds the trap open and ready), it trips the spring and finds itself trapped between the two jaws. An effective trap, economical and very easy to use in your fight against moles.

Sku. 129710020	Sold singly			100
Sku. 129710013	Triggers in packs of 10			150



WATCH A VIDEO
PRESENTATION
OF THE SINGLE RIVET
MOLE TRAP

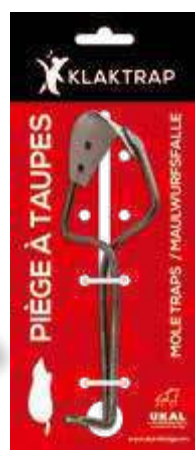

SINGLE RIVET MOLE TRAP



The single rivet mole trap is very simple to use. It is set by hand. A very effective way to rid your garden of moles. Place a trap at each end of the tunnel. Insert the trigger between the jaws.

Sku. 129710030	Pack of 2			100
Sku. 129710031	Triggers in packs of 10			150

DOUBLE RIVET MOLE TRAP



Double rivet mole traps are a highly effective way to eradicate moles once and for all! Easy to use, high quality!

Sku. 129710040	Sold singly			
Sku. 129710041	Triggers in packs of 10			



WATCH A VIDEO PRESENTATION OF THE DOUBLE RIVET MOLE TRAP

TUNNEL TUBE MOLE TRAP



Allows the capture of a live mole thanks to an anti-return flap that closes behind the mole once it has entered inside the trap and prevents it from getting out. Simple to use. Simply place the tube mole trap in a tunnel used by animal, then close it again. The mole enters the tube and cannot get out again. You can then release it elsewhere.

Sku. 129710050	Sold singly			
-----------------------	-------------	--	--	--



BAVARIA-TYPE MOLE TRAP



The Bavaria-type mole trap is simple to use and very effective. Very easy to install - no tools required. Bavaria-type mole traps come in packs of 2 to maximize your chances of capture.

Sku. 129710060	Pack of 2 Limited stock			
-----------------------	----------------------------	--	--	--



WATCH A VIDEO PRESENTATION OF THE BAVARIA-TYPE MOLE TRAP

PUTANGE ANTI-MOLE KIT



The perfect environmentally friendly way to eradicate moles easily and effortlessly. Suitable for beginners and professionals. Kit contains 8 Putange traps, 1 pair of setting pliers, 10 triggers and 1 instruction sheet. Check out our YouTube channel to see how to install your traps step by step and get rid of these underground invaders for good! The kit contains: 8 Putange traps, 1 pair of setting pliers, 10 triggers and 1 instruction sheet.

Sku. 999KIT129710010	PUTANGE mole kit			
-----------------------------	------------------	--	--	--



WATCH A VIDEO PRESENTATION OF THE PUTANGE MOLE TRAP



Swisshino Solutions is a Swiss company, experts in its fields, dynamic and creative. Their main mission is to develop and market innovative products. "We protect what you love".



Mice



ULTRASONIC RODENT REPELLER



Ultrasonic rodent repeller continuously emitting high-frequency sound waves that drive mice and rats away. Simple and safe to use. The sound waves are inaudible to humans. Designed to repel most rats, mice and other pests. Environmentally friendly: no chemicals or poisons. Mains operated.

Sku. 129816001	Small model - 15 m ²		
Sku. 129816002	Large model 30 m ²		



SUPERCAT MOUSE TRAP



Natural ready-to-use bait: the bait used is a non-toxic product that is highly attractive to mice. The bait keeps for 3 to 6 weeks once opened. Extraordinarily high capture rates: thousands of users have reported huge numbers of animals captured in a short space of time. Swiss design: powerful spring mechanism. Hygienic: no-touch disposal of dead rodent. Child-safe. The snap-shut jaws are designed to kill mice, but not harm children or pets. Suitable for indoor and outdoor use. Reusable and recyclable. Made in Europe.

Sku. 129805008	Shelf display 8 x 2		
Sku. 129805	Floor display 40 x 2		
Sku. 129805014	Counter display 14 x 2		
Sku. 129805900	Bait refill x 6		
Sku. 129805100	Liquid bait refill x 2		

NO SEE NO TOUCH MOUSE TRAP



The SWISSINNO No See No Touch mouse trap rids you of mice safely and hygienically. The patented trap system means the user does not have to see or touch the dead animal. This trap has proved itself to be more effective than other products on the market thanks to the use of 100 % natural bait. Bait refill available. Made in Europe.



WATCH A VIDEO PRESENTATION OF THE NO SEE NO TOUCH MOUSE TRAP

Sku. 129809	Mouse trap		
Sku. 129808010	Bait refill x 6 Limited stock		

CLASSIC MOUSE TRAP FSC



The SWISSINNO Classic mouse trap is the perfect tool to rid you of rodents in total safety. FSC-certified wood (Forestry Stewardship Council). This logo guarantees consumers that the wood used is from ecologically managed forests. Highly efficient thanks to its hammer, its bait hook and a powerful spring. Made in Europe.



Sku. 129813024	Shelf display 24 x 2	
-----------------------	----------------------	--

Rats

SUPERCAT RAT TRAP



The bait used is a natural non-toxic product that is highly attractive to rats. Powerful spring mechanism. Hygienic no-touch disposal of dead rodent. The snap-shut jaws are designed to kill rats quickly. Suitable for indoor and outdoor use. Reusable thanks to the bait refills. Nail to the ground.



Sku. 129807004	Shelf display x 4	
Sku. 129807012	Counter display x 12	
Sku. 129807	Floor display x 25	
Sku. 129807900	Bait refill x 3	
Sku. 129805100	Liquid bait refill x 2	





SUPERCAT PRO RAT TRAP

A smart trigger mechanism combined with a powerful hammer-blow killing system are the main features of the SUPERCAT PRO rat trap. This system eliminates rats quickly, reliably and in a species-relevant way. Rodents are attracted by a natural bait that contains neither poison nor chemicals. This rat trap already meets forthcoming European standards and stands out as a pioneering product in humane pest control. The dead rats can be disposed of easily without having to touch them. To do this, simply hold the trap and press on the back of the top flap. Natural bait included. Made in Europe.

Sku. 129819004

Shelf display x 4
Limited stock



CLASSIC WOODEN RAT TRAP FSC

The SWISSINNO Classic rat trap is the perfect tool to rid you of rodents safely. The trap platform is made of FSC-certified wood (Forestry Stewardship Council). This logo guarantees consumers that the wood used is from ecologically managed forests. Highly efficient thanks to its hammer, its bait hook and a powerful spring. Made in Europe.

Sku. 129812



Shelf display x 10



OUTDOOR ULTRASONIC REPELLER

The SWISSINNO ultrasonic animal repeller deters **mice, rats, cats, dogs, foxes and other undesirable visitors** using powerful ultrasound. Effective protection up to a distance of 10 metres within a 120° angle. Covers an area of about 100 m². The repeller is equipped with a solar panel to recharge its AA rechargeable batteries (not supplied). Made in Europe.

Sku. 129816003



100 m²



Voles



VOLE TRAPS

Easy-to-use, highly effective vole trap. Can be used in any direction in the tunnel. No danger to users or pets. **Reusable.** Made in Europe.

Sku. 129804006



Vole trap x 6



Sku. 129804012



Counter display x 12

Sku. 129804004



Planter and probe accessories x 4



Moles

SOLAR MOLE REPELLER



Emits sequential vibrations that disturb the moles. Easy to set up: just plant in the ground. Ergonomic design: easier to push into the ground. Ideal for gardens, lawns, sports grounds and golf courses. Effective over an area of about 650 m². Harmless to your family, pets, the environment, earthworms and insects in the ground. Perfectly waterproof.



Sku. 129710



7 640104 977049

Solar mole repeller



SUPERCAT MOLE TRAP



Quick and easy to use. Traps moles entering on both sides of the trap. The handle wings are lowered when a mole has been trapped, allowing you to monitor the trap from a distance.

Sku. 129818



7 640104 972341

Mole trap



Sku. 129804004



7 640104 975809

Planter and probe accessories



Hunting

BEECH TAR FOR HUNTERS



Used to confine wild boar to a given territory. The ideal complement to crude tar. Easy to spread as it is less viscous than the hunters' special pine tar. Excellent value for money.

Sku. 000027

5 kg



3 700393 963827



Traps for licensed trappers

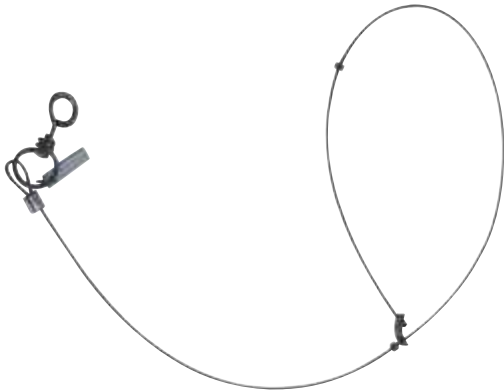

SNARES

For foxes only. The very flexible wire and its irremovable slide are indispensable to facilitate capture. This snare has a latest-generation anti-return feature which prevents the snare re-opening once it is closed. It also has an end stop. The very thick cross-section of its swivel ensures solidity after capture. The stop (crimped) on the wires is crushed steel and not aluminium (non-shiny at night). The snare has a tag to engrave the trapper's number. Ideal for capturing foxes.

Sku. 129704100	10 white snares / Ø 1,6 mm	3 700393 938450	
Sku. 129704101	10 black snares / Ø 1,6 mm	3 700393 938467	
Sku. 129704201	10 black snares / Ø 2 mm	3 700393 938481	
Sku. 129704202	10 white snares / Ø 2mm	3 700393 928758	
Sku. 129704300	10 white snares / Ø 2,3 mm	3 700393 938498	



BAITED FOOHOLD TRAP

Baited foothold trap, sometimes called a kill trap, 30 cm in diameter, ideal to capture foxes and beech martens quickly and easily. Simply place the bait of your choice in the trap, set it and wait for the pest to be caught. Sturdily made and painted by cathaphoresis to limit rusting and reduce the odour of human beings. This is an ideal trap to rid a roof space of beech martens or protect a chicken run from foxes or martens. It is easily set and you'd be surprised at how effective it is. Use this baited trap to capture pests like beech martens and foxes with ease! The mechanical parts are laser cut for greater stability and reliability.

Approval no. PHE 608.

Sku. 129700009	30 cm	3 338020 082483	
-----------------------	-------	-----------------	--



EGG BAIT FOOHOLD TRAP FOR BEECH MARTENS

Category II trap. For capturing beech martens in particular. Designed to be set up indoors (hen house, barn, roof space) or outdoors, where it will be covered with straw or leaves to make it look like a nest. This type of trap is triggered when the animal removes the bait. It features a safety device, which it is preferable not to forget to use. The mechanical parts are laser cut for greater stability and reliability.

Approval no. PHE 609-610





Sku. 129700010	25 cm	3 338020 078288	
Sku. 129700011	30 cm	3 338020 081714	



BELISLE TRAP

The Belisle is commonly used to capture foxes. This trap allows the pest to be caught safely thanks to the lace that tightens when it places its paw in the trap. Safety device and setting wedge included in the trap.

Approval no. PHE 804.





Sku. 129700020	Sold singly		
Sku. 129700022	Spare wire		



FRENCH-STYLE LEGHOLD TRAP

Category IV trap: permit required. Traps must be checked within two hours of sunrise. The French-style leghold trap is a trap with a large trigger plate which improves the capture rate, and wide, hard-rubber lined jaws for a good grip of the leg. For use only by licensed trappers. Supplied with a lace. Trigger sensitivity adjusted by a Teflon screw and washer. The mechanical parts are laser cut for greater stability and reliability.

Approval no. PHE 819.





Sku. 129700025	Sold singly		
Sku. 129700022	Spare wire		



CONIBEAR TRAP

The conibear trap is compact and easy to transport. It has a powerful spring as well as a multi-position trigger. The sensitivity of the trap is adjusted by changing dog notches. Consists of a rigid, hand-riveted frame. You will be surprised by the quality of manufacturing of the device. Is used with bait placed on the trigger or in the cage, which directs the animal and increases the chance of capture. Its use is prohibited on regular animal paths. It is very effective in a small garden, in bales of straw or burrows. As it is not selective, it is prohibited in areas where multiple animals pass through.





Approval no. PHE G664.

Sku. 129701002	1 trap with 2 springs - 13 cm		
Sku. 129701003	1 trap - 18 cm		

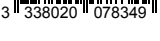

SAFETY SYSTEM FOR CONIBEAR TRAPS

This safety system is specially designed to safely set conibear traps of all sizes. Don't risk injury any longer and set your traps in just seconds with this safe system. Can be used on all conibear traps.

Sku. 129701020	Setting tool for conibear traps - Sold singly		
Sku. 129701021	Simple setting key for conibear traps - Sold singly		



Gas cannon



VERBRUGGE GAS CANNON
BIRD SCARERE

Device with double gas injection and a housing protecting the mechanism. Protects an area of 1 to 4 hectares depending on the terrain and vegetation. Piezoelectric ignition system for about 200,000 detonations. Interval regulator to set detonations at intervals of from 30 seconds to 30 minutes as required. Propane fuel only. One bottle provides approximately 25,000 detonations. Can be fitted with a timer for more flexible use of the gas cannon.

Tips: Ideal for protecting field crops during sowing and before harvesting (maize, peas, sunflowers, cereals, vines, etc.). Scares away birds and protects your fruit crop.

Sku. 129703600 Quatz gas cannon 4 014803 700735

Birds and pigeons



MAGPIE AND CROW TRAP



Formidably effective and operational as soon as it is installed. Can be used in particular to capture decoy birds for magpie or crow cage traps. Simply bait according to the species you wish to catch with eggs, seeds, bread, fruit, etc. The bird is trapped when it comes to take the bait: it is not injured or killed and can be released if necessary. Do not use meat as bait.

Sku. 129703011 Small model 42 x 42 cm 3 338020 081813

Sku. 129703010 Large model on a post 75 x 80 cm 3 338020 081806

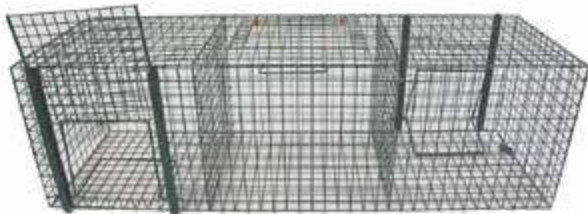

CROW CAGE TRAP WITH PERCH



Size suited to corvidae. The entry doors are oversized, making it particularly effective. Supplied with perch and central decoy bird compartment. 3 compartments.

Tips: It is the responsibility of the consumer to comply with applicable regional or national legislation relating to the use of these products and to trappable species.

Sku. 129703030 92 x 31 x 31 cm 3 338020 083824



OCTAGONAL MAGPIE CAGE TRAP



This very effective trap is used with a central decoy bird that attracts other birds of the same species. **4 entries around the periphery.** Hatches close with a tilting perch system. Allows the bird to fly around the trap to find the entrance. The octagonal shape guides the magpie towards the entrance which is most visible to the bird (prevents the bird flying round without entering the trap). Entirely powder coated. Welded wire mesh. Wire thickness 1,8 mm. Also suitable for crows.

Tips: Place your cages in an open space, avoiding trees. Look after your decoy bird (water + food) because it is essential for this trap to work. If you have no luck with your decoy bird, don't hesitate to replace it. In the Haut-Rhin region of France a Prefectoral order dated 27 June 2017 removed the Eurasian magpie from list of species classified as harmful (List II).

Sku. 129703002 30,5 x 100 x 88 cm 3 700393 971501

—
5-ENTRIES ROUND CAGE TRAP



Drop-down doors around the edge of the trap. **5 entries around the periphery**, with doors triggered by a tilting perch system. This cage will capture large numbers of birds, especially in spring, the period of reproduction and birth. Ø: 80 cm. Height: 32 cm.

Sku. 129703001 32 x 80 cm 

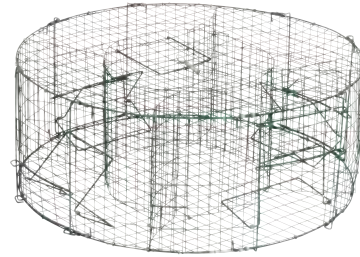

—
Traps

—
RABBITS TRAP



This trap can be useful if you need to catch rabbits in one place to release them in another. Even used alone, you will get good results because the tilting door requires no surveillance. Once inside, the animal cannot go back out as the door closes behind it. The rabbit is caught alive and unhurt. It can be released elsewhere. Length: 81 cm. Ø: 13 cm.

Tips: It is the responsibility of the consumer to comply with applicable regional or national legislation relating to the use of these products and to trappable species.

Sku. 129704001 Ø 13 x 81 cm 

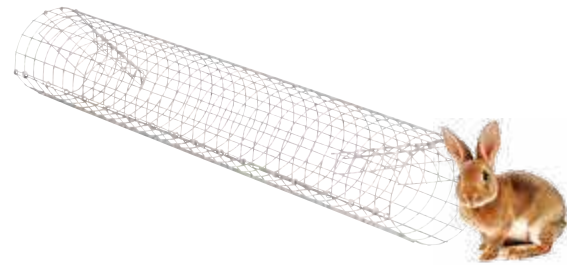

—
WEASEL BOX



This trap does not necessarily need to be baited, as the animal will generally enter out of curiosity. This type of trap is harmless and effective. It can be placed anywhere (woodpile, barn, chicken coop, etc.). It is a very selective trap: it only lets in the smallest animals. The system is simple: when the animal enters the trap, the trigger plate tips forward, the anti-return system activates and prevents the trigger plate tipping back again, ensuring the animal is a prisoner in the cage.

Tips: Soak the box with a scented liquid bait. This will make the trap more attractive and increase the number of catches. The entrance of the box must not be raised off the ground, but level with it.

Sku. 129704003 49 x 6 x 8 cm 





—
2-ENTRIES CAGE TRAP WITH SLIDING DOORS



Category 1 trap. This 64, 103 or 130 cm long cage trap is ideal for capturing foxes (103 and 130 cm), beech martens, rats and any other mustelids. It has 2 doors and is ideally placed on a path frequented by the pest. The animal will walk through it and be captured when it steps on the ultra-sensitive trigger plate. Make sure you block up any other passages so that the animal is forced to walk through the trap. Scented bait is recommended. Includes a carrying handle. The cage trap can also be used with just one door open, by placing some bait at the far end of the cage. Very effective and totally harmless, it can be used anywhere (woodpile, barn, chicken coop).

Tips: It is the responsibility of the consumer to comply with applicable regional or national legislation relating to the use of these products and to trappable species.

Sku. 12970222020 64 x 21 x 21 cm 

Sku. 12970223530 103 x 31 x 31 cm 

Sku. 12970224535 130 x 36 x 47 cm 







**CAGE TRAP WITH SLIDING DOOR
RAT TRAP**



This compact, easily handled cage trap is ideal for capturing rats. Its 19 x 19 mm mesh is perfect to ensure the animal is not injured and cannot escape once captured. Sturdily made, it will resist any weather thanks to its green epoxy paint finish. It will also blend into any environment with no difficulty. Available in versions with 1 or 2 doors. Lightweight and easy to transport thanks to its integrated handle, you can take this trap anywhere. With it you can trap easily, quickly and for a long time to come!



Sku. 129701502020	1 door - 50 x 20 x 20 cm	
Sku. 129702502020	2 doors - 50 x 20 x 20 cm	



**SINGLE-ENTRY CAGE TRAP
WITH SLIDING DOOR**



62, 82 or 127 cm long cage trap, ideal for capturing rats and beech and pine martens. It has one entrance with a drop-down door. Robust, but lightweight, this trap is easy to transport with its integrated carrying handle. The trigger plate at the end of the trap is ultra-sensitive, which ensures that the animal cannot get out again once the door has dropped. The 127 cm cage has a compartment for live bait. Irresistible to predators. This cage trap features a fast-closing sliding door, for safe and easy manipulation of the trap. Very effective and totally harmless, it can be used anywhere (woodpile, barn, chicken coop).



Sku. 1297021254535	With live bait compartment 127 x 36 x 47 cm	
Sku. 12970213030	82 x 32 x 31 cm	
Sku. 1297021602020	62 x 21 x 21 cm	



**2-ENTRIES CAGE TRAP
WITH INVISIBLE DOORS**



Cage trap with a revolutionary setting system designed in the USA that makes the doors virtually invisible to the animal, thereby increasing the chances of catching the fox, marten or any other animal of a similar size. This trap has 2 doors and is ideally placed on a path known to be used by the pest. Simple to use, this cage trap can be set in seconds. It is easily transported thanks to its carrying handle. It is robust and of superior quality. The wild animal cage trap's steel doors are coated with green epoxy paint.

Sku. 12970222523	102 x 30 x 21 cm	
Sku. 12970223030	127 x 26 x 26 cm	

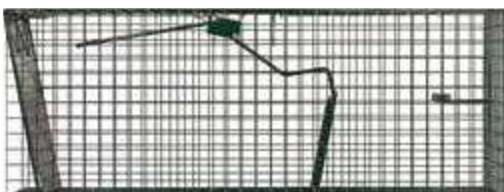

1-ENTRY COYPU CAGE TRAP



Category 1 coypu trap, size 82 x 31 x 31 cm. The unique bait rack ensures the bait is highly visible, so that the trap is even more effective. The epoxy-painted door is invisible to the animal when open. The Ø 2,6 mm wire mesh prevents the trap rusting whilst allowing it to blend in with its surroundings. Even if placed at the water's edge, it will keep its appearance and effectiveness for many years.

Sku. 1297021823030	82 x 31 x 31 cm	
---------------------------	-----------------	---



UKAL

—

INSECT CONTROL

- 200 **Swissinno**
- 201 **Beaumont**
- 204 **Fly Buckets**
- 205 **Sticky**

Flies & Mosquitoes



NATURAL CONTROL FLY TRAP



The impressively effective Natural Control fly trap is specially designed for use outside, but can also be used indoors. Can be composted. Place in the sun. The trap is supplied complete with natural bait made from food protein that has a strong power of attraction for all kinds of flies. Contains no chemicals. Flies are irresistibly attracted by the trap. Once inside, the shape of the trap prevents them getting out again and they are trapped. You can choose to hang the trap or stand it on a flat surface! Ideal for use outdoors: garden, courtyard, play area, patio, kennel.

Sku. 129550	Natural Control fly trap		
Sku. 129550001	2 bait refills		



LED PREMIUM INDOOR INSECT DESTROYER



Flying insects (flies, pantry moths, mosquitoes) are attracted by the ultraviolet light and immediately killed by the high-voltage grid. Dead insects drop into the collection tray, which is easily removed for emptying and cleaning. The ultraviolet light is safe for humans and pets. Compared to a fluorescent lamp, a LED uses half the power (watts) to generate the same light output (lumens) and has a much longer lifespan. The high-voltage electric grid is a new design that greatly increases the capture rate. It meets all CE safety requirements.

Sku. 129508	Mini 3W LED 15 m ²		
Sku. 129508010	10W LED 40 m ²		



INSECT CATCHER



The insect catcher attracts and exterminates flying insects with extraordinary efficiency (flies, mosquitoes). They are sucked into a container by a powerful fan. Covers an area of 80 m². Contains no chemicals or poisons. Generates no fumes or odours and causes no pollution. The product is compact with a modern look, and is suitable for use in any room in the home. It is also the ideal solution for industrial and commercial premises.

Sku. 129508022	22W 80m ² Limited stock		
-----------------------	--	--	--

Horseflies



INSECT FREE HORSEFLY SPRAY

Contains Icaridin (20,60 %), which is officially approved for use against horseflies. Protects horses against horseflies, mosquitoes and flies for 24 hours in high temperatures when horses sweat. Protects both horse and rider. Pleasant smell, does not stain, non-sticky. Spray the product onto the horse all over and covering as much as possible, from a distance of 15 to 20 cm. However, avoid applying directly to mucous membranes and wounds. Apply to the rider on the uncovered parts of the body (hands, arms, legs). Avoid the eyes. Contents: 500 ml.

Sku. 129590	500 ml		
--------------------	--------	--	--

Fly control

NEW



FLY SWATTER

An essential on the market! The BEAUMONT fly swatter is light and handy to help you eliminate flies and other flying insects quickly and efficiently. **Its advantage:** its aestheticism will make the difference in the shelves!





Sku. 129511	Plastic		
-------------	---------	---	---

STYLE INSECT KILLER

This insect killer uses a specially treated UV-A light to attract mosquitoes and flies. Coverage: 80 m². Powerful, silent fan. No electric grid. High-power LED tube, highly attractive to insects. Ultra long tube life: up to 20,000 hours. Fire-resistant ABS plastic for maximum safety. With its anti-escape system, insects have no way out. Removable collection tray for easy cleaning. No high voltages, safe to use. Suitable for home use in bedrooms, living rooms, etc.



WATCH A VIDEO PRESENTATION OF THE STYLE INSECT KILLER

Sku. 129510	LED 5W - 80 m ²		
-------------	----------------------------	---	---

XTRA LED INSECT KILLER

This insect exterminator uses treated UV-A light to attract mosquitoes and flies. Its high-performance anti-leak system leaves insects no chance. They cannot escape from this exterminator. It has a powerful silent fan. No electric grid. Its LED tube light is very powerful and makes it very attractive to insects. The ABS plastic used is fire-resistant for maximum safety. Its collector base is removable for easy cleaning. Operates at low voltage and is therefore safe and reliable for its users. Non-toxic, spray-free and environmentally friendly. It is suitable for both domestic use (bedrooms, living room, etc.) and outdoor use. Its IPX4 rating means that it is suitable for all weather conditions and resists high temperatures. Splash-resistant, but must not be immersed in water. This exterminator can also be used as decorative objects thanks to its neat, refined design.



Sku.129509100	100 m ² Limited stock		
---------------	-------------------------------------	---	---

NEW



18W INSECT KILLER

This insect exterminator uses a special treated UV-A light to attract mosquitoes and flies. The insects are killed when they touch the high-voltage inner grid. Ideal for domestic use **indoors or outdoors**. Power: 18 W. High efficiency UV-A lamp for luring insects. Coverage: 160 m². Average tube life: 10,000 hours. Vertical inner grids are galvanised metal to ensure virtually 100 % of insects are killed. Easy-to-replace UV-A tube. Removable collection tray for easy cleaning. Fire-resistant ABS plastic for maximum safety. Non-toxic and eco-friendly. Can be hung or used standing on the floor. Aesthetic shape IPX4 for indoor or outdoor use.



Sku. 129509200	160 m ²		
----------------	--------------------	---	---

Sku. 9129509200	Fluorescent bulb		
-----------------	------------------	---	--



WATCH A VIDEO
PRESENTATION OF THE
36W INSECT KILLER



36W INSECT KILLER



This insect killer uses specially treated UV-A light to attract mosquitoes and flies. Coverage: 600 m². The insects are killed when they touch the high-voltage inner grid. For domestic and professional use. Average tube life: 8,000 hours. Removable collection tray for easy cleaning. Fire-resistant ABS plastic for maximum safety. Non-toxic and eco-friendly. IPX4. Can be hung or used standing on the floor. 24 x 24 x 56 cm.

Sku. 129509	600 m ²		
Sku. 9129509	Fluorescent bulb		

TRADITION INSECTS KILLER



Stainless aluminium housing. Highly attractive ultra-violet neon strip lights. Insect collection tray. **Designed for indoor use only.** Can be used in all types of professional and domestic buildings: processing facilities, dairies and livestock buildings, etc. Night and day protection against: flies, horseflies, midges, mosquitoes. Insects are attracted to the light source and electrocuted before falling into the collection tray.

USP: Chemical-free, low-energy system. **SAFETY GLASS!** The insect killer contains a powerful ultraviolet neon strip light that attracts mosquitoes and other insects.

Sku. 129503015	15 W - 80m ² 50 x 26 x 8 cm		
Sku. 129503030	30 W - 120m ² 50 x 26 x 8 cm		
Sku. 129503040	40 W - 140 m ² 65 x 36 x 8 cm		
Sku. 129503060	60 W - 160m ² 65 x 36 x 8 cm		

"INSECT O KILL" INSECTS KILLER



The ultraviolet light emitted lures insects into the device's active zone. A high-voltage current flows through the grid in front of the fluorescent tubes. On contact with the grid, the insects are killed instantly and hygienically. The collection tray is easily removed and emptied. With hanging system. 220-240V/50-60Hz. Particularly suitable for agriculture, hotels, restaurants, shops (butchers', bakers', supermarkets), office spaces, as well as all food processing plants and the private sector.

USP: Designed for indoor use.

Sku. 129504016	16 W (2 x 8 W) - 100 m ² - 35 x 10 x 27 cm		
Sku. 129504030	30 W (2 x 15 W) - 120m ² - 51 x 10,5 x 31,5 cm		
Sku. 129504040	40 W (2 x 20 W) - 140m ² - 66,5 x 10,5 x 37 cm		

INSECTS KILLER 360°



The new generation of insect killers. This insect killer uses ultraviolet light, which attracts flying insects to the active area of the device. The UV tubes are protected by a plastic film that makes the glass more resistant. It keeps the glass in place if the tube is broken. There is an electrified grid in front of the light tubes. When an insect comes into contact with this grid, it is immediately and hygienically killed. It drops into the collection tray. **The insect killer is class IPX4**. It is therefore splash-proof and rain-proof. A real plus to protect you from insects! **360° opening for a better insect attraction zone.** This means insects are attracted across a wider area. This insect killer's 360° attraction power is a real bonus! The device is environmentally friendly as it uses no toxic products. For indoor or outdoor use. For use in the home, restaurants, farms, stables or even on a large patio. Comes with a hanging system. 3 models are available; 16 W, 30 W and 40 W, with a respective coverage of 100 m², 120 m² and 140 m².

USP : 360° opening-Outdoor use.

Sku. 129507016	Insects killer 16 W 100m ²		
Sku. 129507030	Insects killer 30 W 120m ²		
Sku. 129507040	Insects killer 40 W 140m ²		



**DISCOVER THE VIDEO
PRESENTATION OF THE
INSECTS KILLER IPX 4
360°**





Fly control



NEW

FLY BUCKETS



Reduces fly nuisance on the farm and around the house with up to 90%
 • traps many flies before emptying is necessary • easy to clean
 The Fly Buckets 12 L is an ideal product to trap stable flies and house flies. This is how it works: Empty the bag with 240 grams of insect attractant (bag is included). We advise wearing gloves for this. Add 6 litres of water, and let the insect attractant mix well. Close the bucket with the lid. When the day turns into night and flies search for a sleeping place, they are drawn to the buckets by the attractant and will enter through one of the six special cones. Once inside the bucket, the insect is not able to get back out. The product is active for 30 to 60 days. When it is no longer working or if the bucket is full of flies, it is possible to scoop out the content and start again. The product has a volume of 12 litres and is easy to clean and re-use when it has filled up with flies.

Sku. 129595	Complete Fly buckets	3	
Sku. 129595001	Filling fly buckets	3	



FLY PROTECTION TAPE REEL

Classic and effective product. Flies are attracted with a natural bait. Pack of 4.

Sku. 129562	Fly protection sticky tape reel	4		
--------------------	---------------------------------	---	---	---



STICKY FLY TAPES



Sticky fly tapes 7 m or 9 m in length, free of chemical residue or powder. Thanks to its strong, instant attractiveness, the Sticky fly trap is a formidably effective way of trapping all the flying insects that touch it. It is thanks to its patterns that the Sticky fly tape is so effective. Its 30 cm width provides a large surface area that flies can easily land on. The Sticky fly tape can be hung virtually anywhere thanks to its metal hanger.

Sku. 129640007	7 m - Sold singly		
Sku. 129640009	9 m - Sold singly		



STICKY FLY STRING KIT



This complete anti-fly kit is the perfect way to get rid of flies quickly and for good! With its 300-metre long sticky fly string, you will maximise your chances of capture! The kit also includes an unwinder so that you can simply and quickly unwind your string for installation in seconds. This anti-fly string is for use in all types of locations, such as livestock buildings, chicken coops, barns or even warehouses. It is recommended that the string only be used indoors to avoid trapping small birds.

With string

Sku. 129633	Kit with 300 m string	
Sku. 129634	String refill 300 m	



STICKY FLY RIBBON KIT



This complete anti-fly kit is the perfect way to get rid of flies quickly and for good! With its 400-metre long, 0,5 cm wide ribbon, which is sticky on both sides, you will maximise your chances of capture! The kit also includes an unwinder so that you can simply and quickly unwind your ribbon for installation in seconds. Complete sticky ribbon kit designed to trap flies in all types of locations, such as livestock buildings, chicken coops, barns or even warehouses. It is recommended that the ribbon only be used indoors to avoid trapping small birds.

With ribbon.

Sku. 129635	Kit with 400 m ribbon	
Sku. 129636	Refill with 400 m ribbon	



NOTES



UKAL

— BEAUMONT FENCING

- 211 HOBBY Range
- 212 CLASSIC Range
- 214 PADDOCK Range
- 216 Permanent fencing
- 217 Connections
- 218 Insulators
- 220 Handle
- 221 Fence posts
- 222 Accessories & testers
- 223 Reels
- 224 Fencing kits
- 225 Nets
- 228 Practical guide

CHOOSING THE RIGHT FENCING

Why use an electric fence?

- To keep your animals safe and protect them from intruders and threats from wild animals.
- To keep your animals in an enclosed space.
- To protect plots of land that you do not want your animals to stray onto.
- To set up mobile fencing to enable your animals to graze on fresh grass.

How does electric fencing for strip grazing work?

An ready-to-use electric fence for strip grazing is an open electrical circuit. The fence energizer generates a very shortlived electric pulse. This pulse lasts a matter of milliseconds. The electric fence for grazing is therefore not dangerous for humans in normal usage conditions. The fence wire and the earth are the electrical conductors.

During operation, no electric current passes through the electric fence.

The electric current only passes when the electrical circuit is closed.

This happens when an animal touches the fence wire. The electrical circuit is closed when the electric pulse passes through the animal and returns to the energizer via the earth. This generates a shock, which guarantees that the fence acts as a deterrent.

When is the electrical circuit not closed?

- When the wire is broken.
- When the electrical conductivity of the fence materials is poor and the current cannot pass.
- When the animal's fur is too thick.
- When the fence is covered with too much vegetation. The current flows into the earth.
- Due to incorrect and insufficient earthing of the fence energizer.
- Due to excessively dry conditions, or when the soil is covered by ice which acts as an insulator.

The importance of earthing

This is the most important aspect, and yet it is the one that is most often neglected when setting up an electric fence. Do not forget that an electric fence will not function if it is not properly earthed. It is important to make sure the earth rod is properly buried in the soil in a place with plenty of moisture. The earth rod cable must be correctly screwed into the energizer terminal.

NOTE: You must not use the earth of the building's mains power supply.

The earth of the mains power supply and the earth of the fence must be at least 10 m apart.

For difficult installations (long fences, very dry soil), maximise efficiency by having multiple earths. If the voltage measured is greater than 300 V (0.3 kV), then the earthing is insufficient and must be improved using additional earth rods.

FENCE HEIGHT

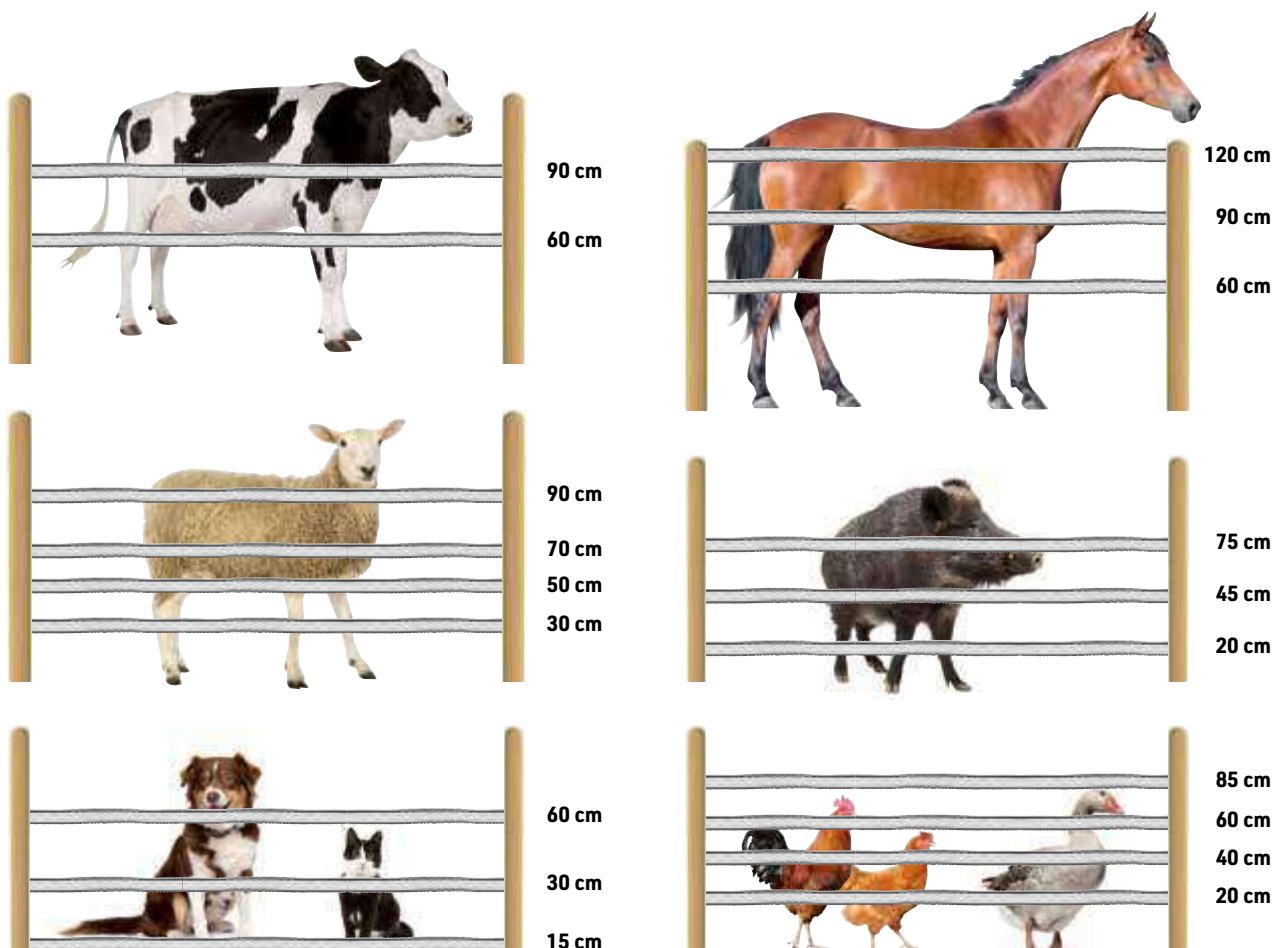

ENERGIZER COMPARISON

Product reference	Product name	Power supply	Stored energy	Output energy	Distance in the laboratory CEE	Number of nets							
-------------------	--------------	--------------	---------------	---------------	--------------------------------	----------------	--	---	---	---	---	---	---

CLASSIC

125920050	P180		0,18 J	0,12 J	4 km	NA							
125921020 125921020SP	RB880	 	1,25 J / 12 V 0,7 J / 9 V	0,98 J / 12 V 0,5 J / 9 V	20 km	5 x 50 m							
125923005	RB85		0,85 J	0,45 J	8 km	2 x 50 m							
125923023	S170		1,7 J	1,4 J	55 km	8 x 50 m							
125923024	S440		4,4 J	3,0 J	115 km	10 x 50 m							
125923025	S510		5,1 J	3,8 J	130 km	12 x 50 m							

PADDOCK

125940050	P180		0,18 J	0,12 J	4 km	NA							
125943980	RB880	 	1,25 J / 12 V 0,7 J / 9 V	0,98 J / 12 V 0,5 J / 9 V	20 km	5 x 50 m							
125943045	S510		5,1 J	3,8 J	130 km	12 x 50 m							
125943005	RB85		0,85 J	0,45 J	8 km	2 x 50 m							

HOBBY

125945005 125945005SP	Hobby P180		0,18 J	0,12 J	4 km	NA							
125945010	Hobby SB230	 	2,3 J	1,13 J	18 km	4 x 50 m							
125945015	Hobby S120		1,2 J	0,9 J	40 km	5 x 50 m							

BEAUMONT QUALITY

Beaumont is a brand with expertise built through years of hands-on experience.

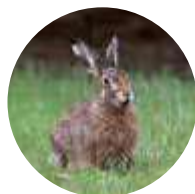

NON-DEFORMABLE



SOLID



WELDED MESH

































The quality of Beaumont nets is tried and tested.
The performance of the products in the field speaks for itself.

Contact us for further information on +33 (0)3 88 07 40 15

















CONDUCTOR COMPARISON

Product reference	Tape/Wire/Rope	Length	Diameter or width	Number of conductors	Conductor type	Résistance	Breaking load							
-------------------	----------------	--------	-------------------	----------------------	----------------	------------	---------------	---	---	---	---	---	---	---

CLASSIC

125165312	Tape	200 m	12 mm	4 x 0,20 mm / 1 x 0,15 mm	-	5,8 ohms/m	115 kg							
125165320	Tape	200 m	20 mm	6 x 0,20 mm / 1 x 0,15 mm	-	3,9 ohms/m	90 kg							
125165340	Tape	200 m	40 mm	8 x 0,20 mm / 1 x 0,15 mm	-	2,90 ohms/m	280 kg							
125165112	Wire	200 m	-	6 x 0,15 mm	Inox	7,20 ohms/m	45 kg							
125165114	Wire	400 m	-	6 x 0,15 mm	Inox	7,20 ohms/m	45 kg							
125165216	Rope	200 m	Ø 6 mm	8 x 0,20 mm	Inox	2,9 ohms/m	450 kg							
125165186	Wire	200 m	-	Conductor stainless steel 3 x 0,15 mm + 1 x 0,20 mm	-	0,53 ohms/m	48 kg							
125165188	Wire	400 m	-	cuiivre 3 x 0,15 mm + 1 x 0,20 mm	-	0,53 ohms/m	48 kg							
125176215	Braided rope	200 m	Ø 5 mm	Conductor stainless steel 4 x 0,15 mm + 1 x 0,20 mm copper	-	0,18 ohms/m	400 kg							

PADDOCK

125167120	Tape	200 m	20 mm	6 x 0,15 mm	Inox	7,2 ohms/m	90 kg							
125167140	Tape	200 m	40 mm	10 x 0,15 mm	Inox	4,32 ohms/m	180 kg							
125167005	Rope	200 m	Ø 5 mm	6 x 0,15 mm	Inox	7,20 ohms/m	120 kg							
125167312	Tape	200 m	12 mm	4 x 0,20 mm + 1 x 0,15 mm	Inox	5,8 ohms/m	115 kg							
125167320	Tape	200 m	20 mm	6 x 0,20 mm + 1 x 0,15 mm	Inox	3,9 ohms/m	140 kg							
125167340	Tape	200 m	40 mm	8 x 0,20 mm + 1 x 0,15 mm	Inox	2,9 ohms/m	280 kg							
125167216	Rope	200 m	Ø 6 mm	8 x 0,20 mm	Inox	2,9 ohms/m	140 kg							

HOBBY

125165410	Tape	200 m	10 mm	3 x 0,15 mm	Inox	14,4 ohm/m	39 kg							
125165450	Wire	300 m	-	3 x 0,15 mm	Inox	14,4 ohm/m	54 kg							



The energizers and conductors for different animal species are given as a guide only.

HOBBY S120 MAINS ENERGIZER



A 230V energizer that performs well with small and medium-sized fences with moderate vegetation. This energizer is the ideal solution for hobby farming and for keeping in small animals, hens, dogs and cats. Anti-UV treatment. 2-year warranty.

Sku. 125945015



230 V



HOBBY P180 BATTERY-POWERED ENERGIZER



9V battery model for mobile fences and short distances with no vegetation. This energizer is the ideal solution for hobby farming and for keeping in small animals, dogs and cats. Anti-UV treatment. 2-year warranty.

Sku. 125945005SP



9 V - 12 V



HOBBY SB230 ENERGIZER



This energizer has 2 possible power supplies (battery or mains). This energizer is the ideal solution for hobby farming, for sheep grazing, and for keeping in small animals, hens, dogs and cats. Comes with battery connection cable and transformer for 230 V power supply. Anti-UV treatment. 2-year warranty.

Sku. 125945010

12 V / 230 V



Caractéristiques techniques	Sku. 125945005SP	Sku. 125945010	Sku. 125945015
Power supply	9 V / 12 V	12 V / 230 V	230 V
Stored energy	0,18 J	2,3 J	1,2 J
Output energy	0,12 J	1,13 J	0,9 J
Voltage	8 500 V	8 000 V	7 800 V
Voltage at 500 Ohms	1 500 V	3 800 V	3 600 V
Power consumption	15 mA / 12 V - 22 mA / 9 V	150 mA	2 W
Indicator light	Yes	Yes	Yes
Distance in the laboratory CEE	4 km	18 km	40 km
Distance with little or no vegetation	2,8 km	11 km	8 km
Distance with moderate vegetation	0,9 km	4,5 km	3,5 km
Distance with dense vegetation	0,2 km	1,3 km	1,2 km
Number of nets	NA	4 x 50 m	5 x 50 m

HOBBY GREEN AND WHITE TAPES



Perfect for optimum current carrying with no loss of energy, the conductors provide excellent fencing for your livestock! UV resistant.

Sku. 125165410



10 mm / 200 m



HOBBY WHITE AND GREEN WIRES



Perfect for optimum current carrying with no loss of energy, the conductors provide excellent fencing for your livestock! UV resistant.

Sku. 125165450



Ø 0,15 mm / 300 m



Technical characteristics	Sku. 125165410	Sku. 125165450
Width x length	10 mm x 200 m	Ø 0,15 mm / 300 m
Number	3*0,15 mm	3*0,15 mm
Resistance	14,4 ohm/m	14,4 Ohm/m
Breaking load	39 kg	54 kg

FENCING BEAUMONT | CLASSIC Range



CLASSIC P180 BATTERY- POWERED ENERGIZER



Practical, easy-to-use battery-powered energizer. Easily transportable, with a long battery life due to its low energy consumption. For fences up to 4 km long without vegetation. Indicator light. 2,5 W solar charger included to increase running time. 2 years warranty.

Sku. 125920050



9V - 12V - Solar panel 2,5 W



CLASSIC RB880 3-IN-1 ENERGIZER



Ideal for long fences. Multifunction energizer. Works on a battery, 9 V batteries, or the mains power supply. 10 W solar panel included. To plug the energizer into the mains, you will need to add a transformer (not included). Handle for easy transport. Battery level indicator. 3 display levels. Multi-purpose, convenient and easy to use. Our recommendation if you are looking for an energizer suitable for all terrains! 2 years warranty.

Sku. 125921020



9V - 12V - 230 V - Solar panel 10 W



Sku. 125921020SP



9V - 12V - 230 V - Energizer only



CLASSIC RB85 MAINS ENERGIZER



This compact, modern energizer is ideal for pet owners. Suitable for medium-length fences: permanent fencing for cattle/sheep/ goats / dog fencing / protective fencing for crops, ponds and gardens. 2 years warranty.

Sku. 125923005



230 V



CLASSIC S170 MAINS ENERGIZER



Shock-resistant ABS housing. Indicator lights. Designed for medium-sized fences. Ideal for medium-sized fences for sensitive species (dogs, horses, etc.). 2 years warranty.

Sku. 125923023



230 V



All our energizers come with a 2-year warranty and a warning sign.

Technical characteristics	Sku. 125920050	Sku. 125921020	Sku. 125923005	Sku. 125923023	Sku. 125923024	Sku. 125923025
Power supply	9 V / 12 V	9 V / 12 V / 230 V	230 V	230 V	230 V	230 V
Stored energy	0,18 J	1,25 J / 12 V - 0,7 J / 9 V	0,85 J	1,7 J	4,4 J	5,1 J
Output energy	0,12 J	0,98 J / 12 V - 0,5 J / 9 V	0,45 J	1,4 J	3,0 J	3,8 J
Voltage	8 500 V	10 800 V / 12 V - 7 000 V / 9 V	7 800 V	9 500 V	10 500 V	10 000 V
Voltage at 500 Ohms	1 500 V	3 800 V	3 800 V	5 000 V	5 700 V	5 600 V
Power consumption	2,5 W	10 W	1 W	3 W	5 W	8 W
Indicator light	Yes	3- steps	No	Yes	2 power outputs	6-step LED voltage indicator, 2 power outputs (one high and one low)
Distance in the laboratory CEE	4 km	20 km	8 km	55 km	115 km	130 km
Distance with little or no vegetation	0,9 km	1,1 km	3,5 km	15 km	20 km	35 km
Distance with moderate vegetation	2 km	2 km	2 km	4,5 km	7 km	13 km
Distance with dense vegetation	0,8 km	1,7 km	0,8 km	1,7 km	2 km	6 km
Number of nets	2 x 50 m	8 x 50 m	2 x 50 m	8 x 50 m	10 x 50 m	12 x 50 m

CLASSIC Range | FENCING BEAUMONT

CLASSIC S440 MAINS ENERGIZER



Shock-resistant ABS housing. Energizer equipped with an operation indicator light and 2 power outputs. Suitable for all animal species. For large and mid-sized fences. 2 years warranty.

Sku. 125923024



230 V



CLASSIC S510 MAINS ENERGIZER



2 power outputs (one high and one low) to adapt the power level to your needs or electrify two separate fences. Powerful energizer for fences up to 35 km long without vegetation and 6 km with very dense vegetation. 6-step LED voltage indicator. Can be used to electrify up to 12 nets. Easy to use. Energizer recommended for long and very long fences in difficult conditions (dense vegetation, animals that are difficult to contain). 2 years warranty.

Sku. 125923025



230 V



GREEN AND WHITE TAPES



Sku. 125165312



12 mm / 200 m



Sku. 125165320



20 mm / 200 m



Sku. 125165340



40 mm / 200 m



GREEN AND WHITE ROPE



Sku. 125165216



Ø 6 mm / 200 m



TWISTED GREEN AND WHITE WIRES



Sku. 125165112



200 m



Sku. 125165114



400 m



BRAIDED WIRES AND ROPES



Sku. 125165188



Braided wires 400 m
Limited stock



Technical characteristics	Sku. 125165312	Sku. 125165320	Sku. 125165340	Sku. 125165216	Sku. 125165112	Sku. 125165114	Sku. 125165188
Width x length	12 mm x 200 m	20 mm x 200 m	40 mm x 200 m	Ø 6 mm x 200 m	200 m	400 m	400 m
Number	4 x 0,20 mm / 1 x 0,15 mm	6 x 0,20 mm / 1 x 0,15 mm	8 x 0,20 mm / 1 x 0,15 mm	Stainless steel conductor 8 x 0,20 mm	Stainless steel conductor 6 x 0,15 mm	Stainless steel conductor 6 x 0,15 mm	Stainless steel conductor 3 x 0,15 mm + 1 x 0,20 mm copper
Resistance	5,8 ohms/m	3,9 ohms/m	2,9 ohms/m	2,9 ohms/m	7,20 ohms/m	7,20 ohms/m	0,53 ohms/m
Breaking load	115 kg	90 kg	280 kg	450 kg	45 kg	45 kg	48 kg

FENCING BEAUMONT | Paddock Range



Paddock P180 BATTERY-POWERED ENERGIZER

Practical, easy-to-use battery-powered energizer. For fences up to 4 km long without vegetation. Indicator light. 2,5 W solar charger included to increase running time. 2 years warranty.

Sku. 125940050



9V - 12V - Solar panel 2,5 W



Paddock RB880 3-IN-1 ENERGIZER

Ideal for long fences. Multifunction energizer. Works on a battery, batteries, or the mains power supply. 10 W solar panel included. To plug the energizer into the mains, you will need to add a transformer (not included). Handle for easy transport. Battery level indicator. 3 display levels. Multi-purpose, convenient and easy to use. 2 years warranty.

Sku. 125943980



9V - 12V - 230 V - Solar panel 10 W



Paddock S510 MAINS ENERGIZER

Energizer equipped with 2 outputs (maximum and reduced) to adapt the power level to your needs or to electrify two independent fences. Powerful energizer for fences up to 30 km long without vegetation and 6 km with very dense vegetation. 6-step LED voltage indicator. 2 power outputs (one high and one low). Easy to use. Energizer recommended for long and very long fences in difficult conditions (dense vegetation, animals that are difficult to contain). 2 years warranty.

Sku. 125943045



230 V



Paddock RB85 MAINS ENERGIZER

This compact, modern energizer is ideal for horse owners. Suitable for medium-length fences. 2 years warranty.

Sku. 125943005



230 V



Technical characteristics	Sku. 125940050	Sku. 125943980	Sku. 125943045	Sku. 125943005
Power supply	9 V / 12 V	9 V / 12 V / 230 V	230 V	230 V
Stored energy	0.18 J	1,25 J / 12 V - 0,7 J / 9 V	5.1 J	0,85 J
Stored energy	0.12 J	0,98 J / 12 V - 0,5 J / 9 V	3.8 J	0,45 J
Voltage	8 500 V	10 800 V / 12 V - 7 000 V / 9 V	10 000 V	7 800 V
Voltage at 500 Ohms	1 500 V	4 500 V / 12 V - 3 000 V / 9 V	5 600 V	3 800 V
Power consumption	15 mA / 12 V - 22 mA / 9 V	90 mA / 12 V - 70 mA / 9 V	8 W	1 W
Indicator light	Yes	3 display levels	6-step LED voltage indicator. 2 power outputs (one high and one low)	No
Distance in the laboratory CEE	4 km	20 km	130 km	8 km
Distance with little or no vegetation	2,8 km	9,5 km	35 km	3,5 km
Distance with moderate vegetation	0,9 km	3,3 km	13 km	2 km
Distance with dense vegetation	0,2 km	1,1 km	6 km	0,8 km
Number of nets	NA	5 x 50 m	12 x 50 m	2 x 50 m

All our energizers come with a 2-year warranty and a warning sign.

BROWN TAPES

These tapes have an anti-UV treatment.

Sku. 125167120



20 mm / 200 m



Sku. 125167140



40 mm / 200 m



GREEN AND WHITE TAPES



Closure électrique - Elektrozaun - Electric fencing

These tapes have an anti-UV treatment.

Sku. 125167320



20 mm / 200 m



Sku. 125167340



40 mm / 200 m



BROWN ROPE



Closure électrique - Elektrozaun - Electric fencing

These rope have an anti-UV treatment.

Sku. 125167005



Ø 5 mm / 200 m



GREEN AND WHITE ROPE



Closure électrique - Elektrozaun - Electric fencing

These rope have an anti-UV treatment.

Sku. 125167216



Ø 6 mm / 200 m



Technical characteristics	Sku. 125167120	Sku. 125167140	Sku. 125167005	Sku. 125167320	Sku. 125167340	Sku. 125167216
Length	20 mm x 200 m	40 mm x 200 m	Ø 5 mm x 200 m	20 mm x 200 m	40 mm x 200 m	Ø 6 mm x 200 m
Number of stainless steel conductors	6 x 0,15 mm	10 x 0,15 mm	6 x 0,15 mm	6 x 0,20 mm + 1 x 0,15 mm	8 x 0,20 mm + 1 x 0,15 mm	8 x 0,20 mm
Resistance	7,2 ohms/m	4,32 ohms/m	7,20 ohms/m	3,9 ohms/m	2,9 ohms/m	2,9 ohms/m
Breaking load	90 kg	180 kg	120 kg	140 kg	280 kg	140 kg

NEED EQUIPMENT FOR YOUR STABLE?

→ See our offer page 103 of the catalogue



FENCING BEAUMONT | Connections and strainers



- GALVANISED STEEL CABLE



Breaking load 200 kg. Good conductivity.

Sku. 125140001 

250 m 

Sku. 125140002 

500 m 



- ZINC-COATED STEEL CABLE



Zinc-coated steel cable with aluminium powder. Excellent conductor. Breaking load 200 kg. Resistance: 0,12 ohms/m.

Sku. 125141 

500 m 



- ALUMINIUM CABLE



Breaking load 200 kg. Good conductivity.

Sku. 125145020 

Ø 2 mm / 400 m 

Lead-out cable



- SOFT LEAD-OUT CABLE



Soft lead-out cable.

Sku. 125450030 

30 m 

Sku. 125450 

50 m 



PERMANENT ELECTRIC FENCE
Choose the optimum solution for your pets !

→ Discover our range in the dedicated brochure



Connections

CONNECTION FOR ROPES



Connection for wire and rope. Guarantees high-quality connections.

Sku. 125139015 3 338020 042999

Stainless steel - By 5

Sku. 125139016 3 338020 085651

Aluminium - By 5



CONNECTION FOR TAPE



Easy to use. Suitable for all standard electric fence tapes. Galvanised metal support. Robust tape connector through the metal support of a part, supported by unbreakable plastic.

Sku. 125139220 3 700393 916458

20 mm - By 10
Limited stock



CONNECTION FOR TAPE



Sku. 125139006 3 388770 020051

20 mm - Aluminium - By 5

Sku. 125139046 3 388770 040059

40 mm - Aluminium - By 5

Sku. 125139120 3 338020 077083

20 mm - Steel - By 5
Limited stock

Sku. 125139140 3 338020 077090

40 mm - Steel - By 5
Limited stock



WIRE STRAINER WITH SPRING



Made of stainless steel.

Sku. 125139020 3 338020 061976

By unit



TAPE STRAINER



Made of aluminium.

Sku. 125139010 3 338020 037995

By unit



Connections cables

TAPE/WIRE CONNECTION CABLE



Sku. 125191 3 338020 042241

By 2



CONNECTOR TAPE AND ROPE



Professional cable for connecting ropes (6 mm max). Stainless steel contact plate. Cable length: 60 cm.

Sku. 125192003 3 700393 941757

By unit
Limited stock



Insulators



RING INSULATOR



Duplicate-moulded. Designed for wire, cable and tape conductors, up to 12 mm. Robust body with screw, perfect for screwing into wooden posts.

Sku. 125201



Black - By 25



Sku. 125201090



Black - By 90

Sku. 125201250



Black - By 250



PREMIUM 3-IN-1 INSULATOR



These uniquely shaped insulators are easy to hold in your hand and to screw in even without a tool. The special feature is the construction of the insulator head. The fence material is inserted easily from above, so the fence material will not fall out at a later date. Special insulator for ropes. Recommended for long fences. Short support. Anti-water-droplet system. Self-tapping screw.

Sku. 125226



Black - By 20
Limited stock



COMBINED WOOD AND STEEL RB INSULATOR



Universal, with captive pin. Fastens to a diameter 10-12 mm steel post at the required height, to a round or flat wooden post with wire, two screws or two nails.

Sku. 125200050



Black - By 50



RBL CAPTIVE-PIN INSULATOR



Fastens to a post with only one wire. For wires or cable conductors. Withstands 15 000 V.

Sku. 125266



Red - By 50



Sku. 125266100



Red - By 100



RBCH INSULATOR



Large model for tapes up to 40 mm, cables and ropes. The screws make it possible to strain the tape properly and install it easily.

Sku. 125223



Black - By 25



INSULATOR FOR WIRE & TAPE, 40 MM



Screw-in insulator for wooden posts. Short support. Self-tapping screw. For tapes up to 40 mm wide. For wires and ropes up to 8 mm in diameter. Extremely long, distinct and tapered screw thread. Self-tapping screw for easy tightening. No need for prior drilling or countersinking in the wood. The insulator screw is made of tempered steel.

Sku. 125225



Black - By 30



INSULATOR FOR TAPE 12 TO 40 MM AND ROPE



12 to 40 mm tape insulator and for rope up to 8 mm.

Sku. 125207



Black - By 25



Sku. 125207090



Black - By 90



IGPB KIT WITH 2 FASTENING PLATES AND 2 RBCH INSULATORS



Kit includes: 2 RBCH insulators, 2 aluminium fastening plates for 40 mm tape.

Sku. 125408003



Black - By unit



DOUBLE ANCHORING INSULATOR



Essential for installing gates.

Sku. 125281



Black - By 2



64



EGG INSULATOR



Standard quality. Ideal for corners. To be used with wire.

Sku. 125231



Black - By 4



65



STANDOFF RING INSULATOR



Black plastic. Allows to create a distance between the animal and the fence.

Sku. 125230



Black - By 10



16

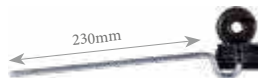

STANDOFF INSULATOR



Duplicate-moulded over 6 mm diameter.

Sku. 125230001



Black - By 10



16

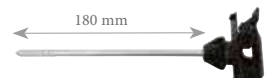

STRAIGHT STANDOFF RING INSULATOR



Black plastic straight insulator. Allows to create a distance between the animal and the fence.

Sku. 125230002



Black - By 10



24



PIGTAIL INSULATORS



Insulator for metal or fibreglass fence posts.

Sku. 125250



White - Ø 10 mm - By 50



20

Sku. 125251



White - Ø 12 mm - By 50



20

Sku. 125253



White - Ø 50 mm - By 25



30



METAL CORKSCREW INSULATOR



For oval posts.

Sku. 125276



Yellow - By 25



18



RB INSULATOR



Universal insulator for wires and tape. Fastens to diameter 6 - 13 mm posts via a nut system.

Sku. 125200400



Black - By 25



15



CONSULT OUR VOLUME OFFER

Sku. B125409200
(box of 200 handles)



FENCING BEAUMONT | Handles

Handles



EXTRA-LARGE BLACK GATE HANDLE WITH HOOK



Can also be used as a spool for spooling wire and tape up to 20 mm max.

Sku. 125404004  3 700393 942242

Black - By unit
Limited stock 





LARGE BLACK SPRING-TYPE, INSULATING HANDLE



With spring. **Sold by the piece in gencoded bulk.**

Sku. 125404002  3 700393 982866

Black  



SPRING TYPE INSULATING GATE HANDLE



Gate handle with extension internal spring.

Sku. 125405010  3 700393 941931

Black - By 10 



SPRING-TYPE INSULATING GATE HANDLE





Solid, economical handle ideal for for installing a gate in the fence. Integral spring reduces tension and wire breakage. Hook screwed to the front **Sold by the piece in gencoded bulk.**

Sku. 125402102  3 700393 982880

Black  





Sku. 125402003  3 700393 982842

Red  



Sku. 125402010  3 700393 982873

Yellow  





INSULATING GATE HANDLE WITH EXTENSIBLE ELECTRIFIED CORD



Elastic kit with insulating gate handle, recommended for horse enclosures. Can be used to create gateways for farm equipment (opening of up to 8 m).

Sku. 125407  3 338020 086108

Black - By unit  





GATE HANDLE WITH 5 M SPRING



Insulating handle with integrated 5 m spring. Easy to set up for temporary fences. Diameter: 2 cm.

Sku. 125406002  3 338020 085972

Black - By unit  



GATE HANDLE KIT WITH 5 M SPRING



Gate handle : 26 cm. 5 m of spring.

Sku. 125406  3 338020 033416

Handle + spring kit
Black - By unit  

Sku. 125406001  3 338020 052431

Spring only - Black
By unit 





INSULATING HANDLE KIT WITH TAPE FASTENING PLATE



Gate handle with plate by piece. Gate handle: 26 cm. Plate: 15 cm.

Sku. 125408002  3 700393 914072

Black - By unit  

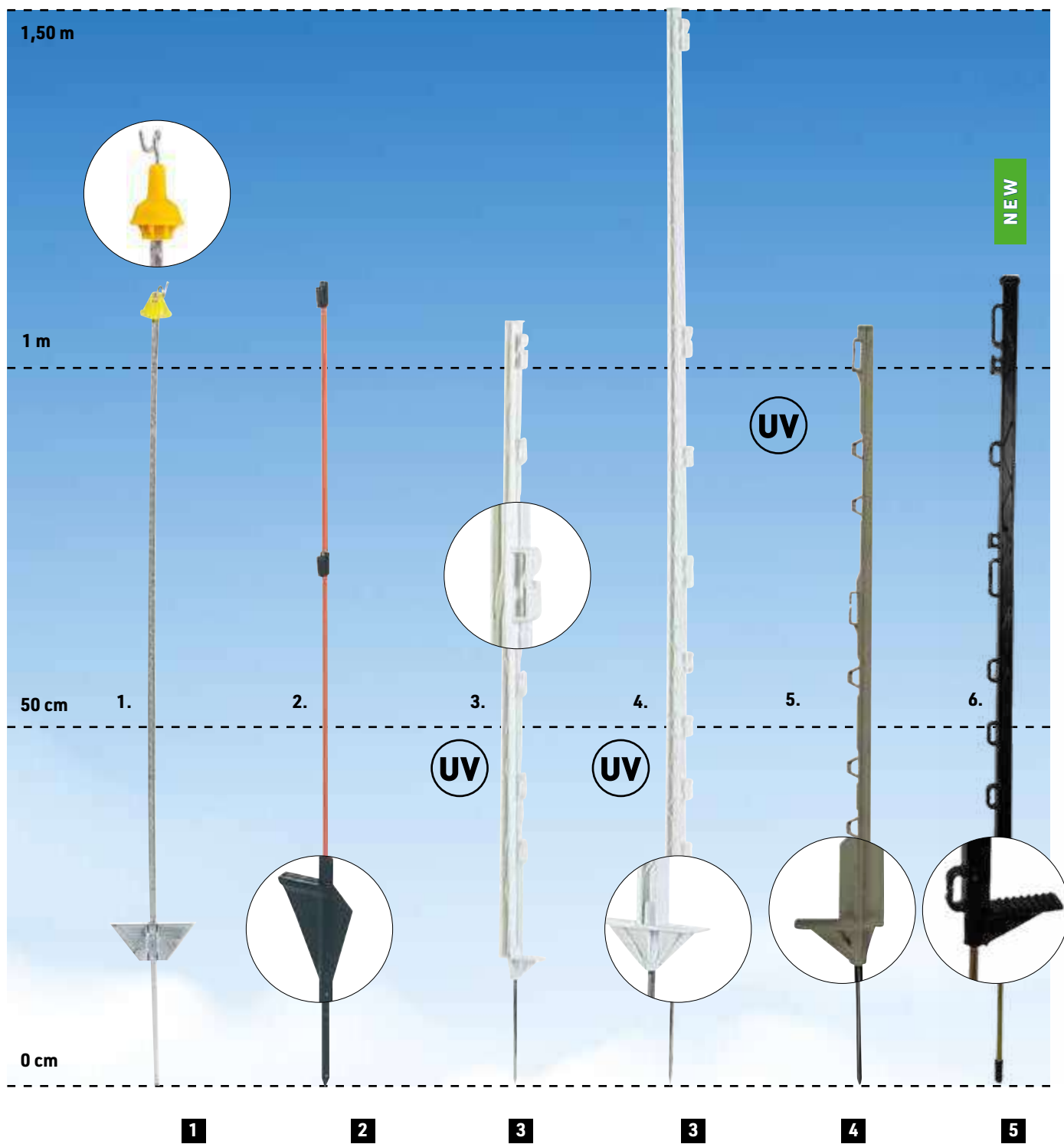

Sku.	125305025	125312050	125331030	125335020	125340107010	125341003
Material	Metal	Fiberglass	Plastic	Plastic	Plastic	100 % recycled plastic
Height*	1,10 m	1,10 m	1,05 m	1,50 m	1,05 m	1,10 m
Number of insulators	1	0	7	8	7	10
Sold in multiples of	25	50	30	20	10	10
Pallet	1 250	1 000	700	700	600	700
Animals						

Gencode



*Measurement includes full shaft.

FENCING BEAUMONT | Accessories & testers



UNIVERSAL FENCE PLIERS

Multipurpose tool. Insulated handle.

Sku. 125296



By unit



Closure électrique - Elektrozaun - Electric fencing



NEW

WARNING SIGNS FOR ELECTRIC FENCING

Must be placed every 50 m on electric fences alongside public roads.

Sku. 125590001



By unit



Closure électrique - Elektrozaun - Electric fencing



SET OF CROCODILE CLIPS

For connecting to an energizer or battery.

Sku. 125865



By unit



Closure électrique - Elektrozaun - Electric fencing



EARTH ROD WITH WIRE

Earth rod with connecting wire and earth line. Sku. 125891.

Sku. 125891



30 cm - By unit



Closure électrique - Elektrozaun - Electric fencing



EARTH ROD

Essential. Essential in order to return the current when an animal comes into contact with the wire.

Sku. 125890



1 m - By unit



Closure électrique - Elektrozaun - Electric fencing



LIGHTNING INSULATOR WITH SPRING

Lightning insulator. When the fence is struck by lightning, it directs the voltage surge generated to the earth and keeps the energizer safe. Your energizer warranty will not be applicable if the energizer has been struck by lightning. Lightning conductors are indispensable to protect your fences.

Sku. 125291



By unit



Closure électrique - Elektrozaun - Electric fencing



Testers



BEAUMONT 12 KV FENCE TESTER

Indicates the status of your fence via six voltage levels ranging from 2 000 to 12 000 V. Very easy to use.

Sku. 125012



By unit



Closure électrique - Elektrozaun - Electric fencing



BEAUMONT DIGITAL FENCE TESTER

This digital voltmeter is the classic measuring instrument. Easy to handle. Rapid testing.

Sku. 125427001



By unit



Closure électrique - Elektrozaun - Electric fencing



SELF-INSULATING REEL



With brake and handle. Mounting holes for attaching to a 30 x 30 mm post (large model) or a 20 x 20 mm post (medium model). Attachment hook.

Sk. 125350



Medium model /
1 000 m of wire



BEAUMONT EURO REEL



Plastic reel, spool attached with a pin. Reel can be locked with a hinged locking arm. Metal attachment hook.

Sk. 125343001



500 m of wire



BEAUMONT STANDARD REELS



Sk. 125361001



Large model
800 m of wire
or 300 to 500 m of tape



Sk. 125361002



Medium model
500 m of wire
or 200 to 300 m of tape



LARGE REEL WITH SLING



Pass the sling over your head and the reel will rest on the operator's stomach.

Sk. 125360



Large model / 1 000 m
of wire



CONSULT OUR OFFER

TURBOMAX  **horizont**
batteries

Sk. 125H12012,
125H14896,
125H14500...

→ Go to page 262



Fencing kits

FENCING KIT FOR VEGETABLE GARDENS



This fencing kit protects your vegetable garden from pets (dogs, cats) and wild animals (boar, deer, etc.). It is easy to set up and contains all the elements required for an effective fence.

The kit includes:

- 1 HOBBY SB230 dual energizer (mains or battery)
- 1 roll green and white tape (12 mm x 200 m) + 5 connections
- 10 plain plastic fence posts (Height 55 cm)
- 1 earth rod
- 2 "gate kits" (insulators with anchor and handles)
- 8 ring insulators.



Sku. 125710



HOBBY SB230 Energizer

FENCING KIT FOR LARGE DOGS



This fencing kit can be used to create a fenced enclosure for large dogs. It is easy to set up and contains all the elements required for an effective fence.

The kit includes:

- 1 RB85 mains-powered fence energizer
- 1 roll green and white tape (12 mm x 200 m) + 5 connections
- 10 plastic fence posts (90 cm)
- 1 earth rod
- 1 "Electric fencing" warning sign
- 10 m lead-out cable
- 5 insulators
- 1 handle with 5 m spring to create a gate.



Sku.125705



CLASSIC RB85 Energizer

FENCING KIT FOR HARD-TO-CONTROL DOGS



The kit for hard-to-control dogs contains a more powerful energizer: the CLASSIC S170 (see pages 10/11 for technical characteristics). It will keep your dog safe and minimize the chances of it running away. It is easy to set up and contains all the elements required for an effective fence.

The kit includes:

- 1 S170 mains-powered fence energizer
- 1 roll green and white tape (12 mm x 200 m) + 5 connections
- 10 plastic fence posts (90 cm)
- 1 earth rod
- 1 "Electric fencing" warning sign
- 10 m lead-out cable
- 5 insulators
- 1 handle with 5 m spring to create a gate.



Sku. 125725 CLASSIC S170 Energizer



Nets

NON-ELECTRIFIED POULTRY NET

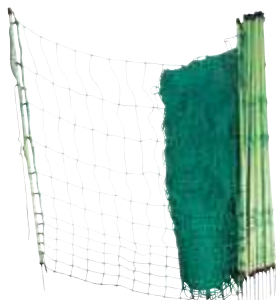

Non-electrified poultry net, height 1,12 m.

Sku. 125584225



25 m



Sku. 125584250



50 m



POULTRY NET, HEIGHT 1.12 M

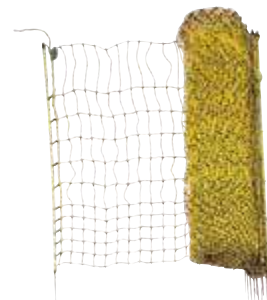

Poultry net, height 1,12 m.

Sku. 125584



50 m



FENCE POST FOR POULTRY NET



Post for poultry net. Height: 1,12 m.

Sku. 125585002



1,12 m



COPPER FERRULE



Sku. 125602

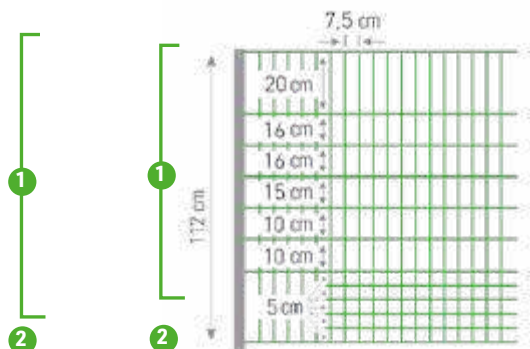

- 1 11 wires: Supporting wire: 3 x 5 monofilament, Ø 0,40 mm; conductor: 3 x 1 stainless steel, Ø 0,20 mm
- 2 1 wire: Supporting wire: 4 x 8 monofilament, Ø 0,40 mm

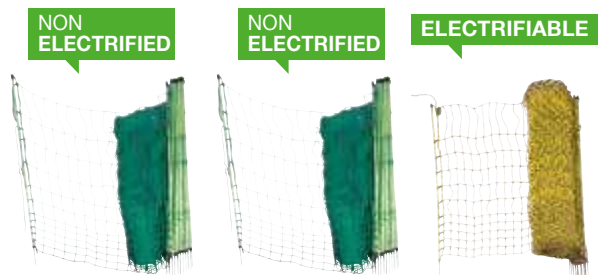

Technical characteristics	Sku. 125584225	Sku. 125584250	Sku. 125584
Length	25 m	50 m	50 m
Height	1,12 m	1,12 m	1,12 m
Electrified	No	No	Yes
Number of posts	9	15	15
Colour	Green	Green	Yellow
Quantity per pallet	66	45	40



FENCING BEAUMONT | Nets



CLASSIC SHEEP NET, HEIGHT 0.90 M

- Height: 0.90 m
- Length: 50 m
- Colour: Yellow
- Number of posts: 14
- **Electrified earth wire**

Electrified horizontal wires, non-electrified vertical wires. Each wire intersection is welded and is thus non-deformable and stronger.

Sk. 125582



50 m

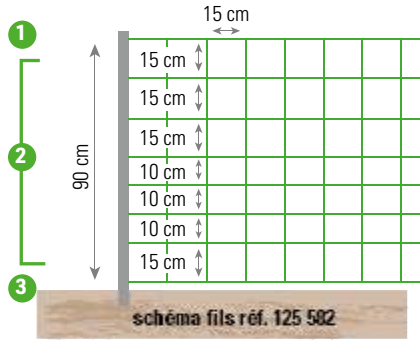

- 1 wire:** Supporting wire: 3 x 8 monofilament Ø 0,40 mm; conductor: 3 x 2 stainless steel Ø 0,20 mm.
- 6 wires:** porteur: 3 x 5 monofilament Ø 0,40 mm; conductor: 3 x 1 stainless steel Ø 0,20 mm.
- 3 1 wire:** porteur: 4 x 8 monofilament Ø 0,40 mm.



KOMBI SHEEP NET, HEIGHT 0.90 M

- Height: 0.90 m
- Length: 50 m
- Colour: orange and green
- Number of posts: 14

With struts. The struts keep the netting in place **when the ground is uneven.**

Sk. 125582001



50 m - Simple



Sk. 125586002



50 m - Double

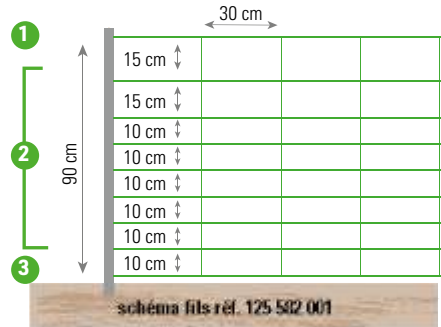

- 1 wire:** Supporting wire: 3 x 8 monofilament Ø 0,40 mm; conductor: 3 x 2 stainless steel Ø 0,20 mm.
- 6 wires:** Supporting wire: 3 x 5 monofilament Ø 0,40 mm; conductor: 3 x 1 stainless steel Ø 0,20 mm.
- 3 1 wire:** Supporting wire: 4 x 8 monofilament Ø 0,40 mm.



FENCE POST FOR SHEEP NET

Replacement fence post for your sheep nets, sold by unit.

Sk. 125585



0,90 m



BORDER NET REINFORCED SHEEP NET, HEIGHT 0.90 M

- Height: 0.90 m
 - Length: 50 m
 - Number of posts: 14
 - Colour: red
- Red with white intermediate posts. **20% more conductive than other sheep nets.** Nets created for heavy users of nets (migratory farmers, mountain farmers).

Sk. 125582003



50 m

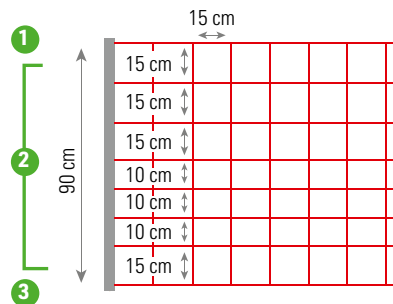

- 1 wire:** Supporting wire: 3 x 8 monofilament Ø 0,40 mm; conductor: 3 x 2 stainless steel Ø 0,25 mm.
- 6 wires:** Supporting wire: 3 x 5 monofilament Ø 0,40 mm; conductor: 3 x 1 stainless steel Ø 0,25 mm.
- 1 wire:** Supporting wire: 4 x 8 monofilament Ø 0,40 mm.



Technical characteristics	Sk. 125582	Sk. 125582001	Sk. 125586002	Sk. 125582003
Length	50 m	50 m	50 m	50 m
Height	0,90 m	0,90 m	0,90 m	0,90 m
Spikes	Single	Single	Double	Single
Struts	No	Yes	Yes	No
Colour	Yellow and White	Orange and green	Orange and green	Red and White
Quantity per pallet	77	66	66	77

GOAT NET, HEIGHT 1.06 M

- Height: 1.06 m
- Length: 50 m
- Colour: Yellow
- Number of posts: 14
- **Electrified earth wire**

Electrified horizontal wires, non-electrified vertical wires. Each wire intersection is welded and is thus non-deformable and stronger.

Sk. 125583



50 m

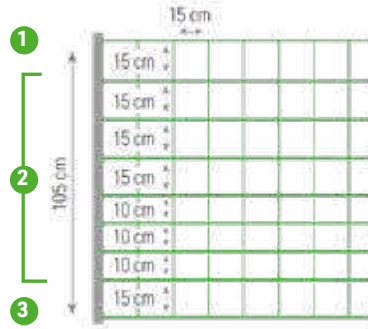

- 1 wire:** Supporting wire: 3 x 8 monofilament, Ø 0,40 mm; conductor: 3 x 2 stainless steel, Ø 0,20 mm.
- 6 wires:** Supporting wire: 3 x 5 monofilament, Ø 0,40 mm; conductor: 3 x 1 stainless steel, Ø 0,20 mm.
- 1 wire:** Supporting wire: 4 x 8 monofilament, Ø 0,40 mm.

KOMBI GOAT NET WITH STRUTS, HEIGHT 1.06 M

- Height: 1.06 m
- Length: 50 m
- Colour: orange and green
- Number of posts: 15

Sk. 125583001



50 m

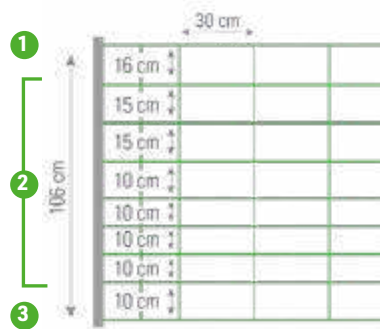
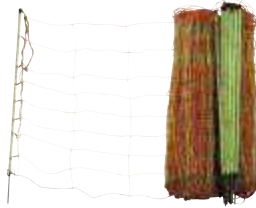

- 1 wire:** Supporting wire: 3 x 8 monofilament, Ø 0,40 mm; conductor: 3 x 2 stainless steel, Ø 0,20 mm.
- 6 wires:** Supporting wire: 3 x 5 monofilament, Ø 0,40 mm; conductor: 3 x 1 stainless steel, Ø 0,20 mm.
- 1 wire:** Supporting wire: 4 x 8 monofilament, Ø 0,40 mm.

FENCE POST FOR GOAT NET

Replacement fence post for your goat nets, sold by unit.

Sk. 125585001



1,06 m



FENCE POST FOR RABBIT NET

Replacement fence post for your rabbit nets, sold by unit.

Sk. 125585003



0,65 m



RABBIT NET, HEIGHT 0.65 M

- Height: 0,65 m
- Length: 50 m
- Colour: Yellow
- Number of posts: 15

Sk. 125584001



50 m

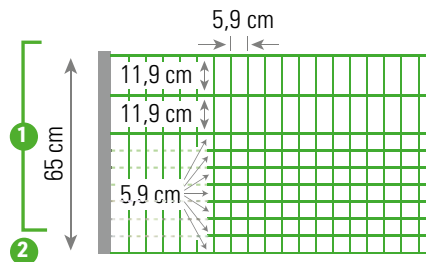

- 9 wires:** Supporting wire: 3 x 5 monofilament, Ø 0,40 mm; conductor: 3 x 1 stainless steel, Ø 0,20 mm.
- 1 wire:** Supporting wire: 4 x 8 monofilament, Ø 0,40 mm.

FENCING BEAUMONT | Practical guide

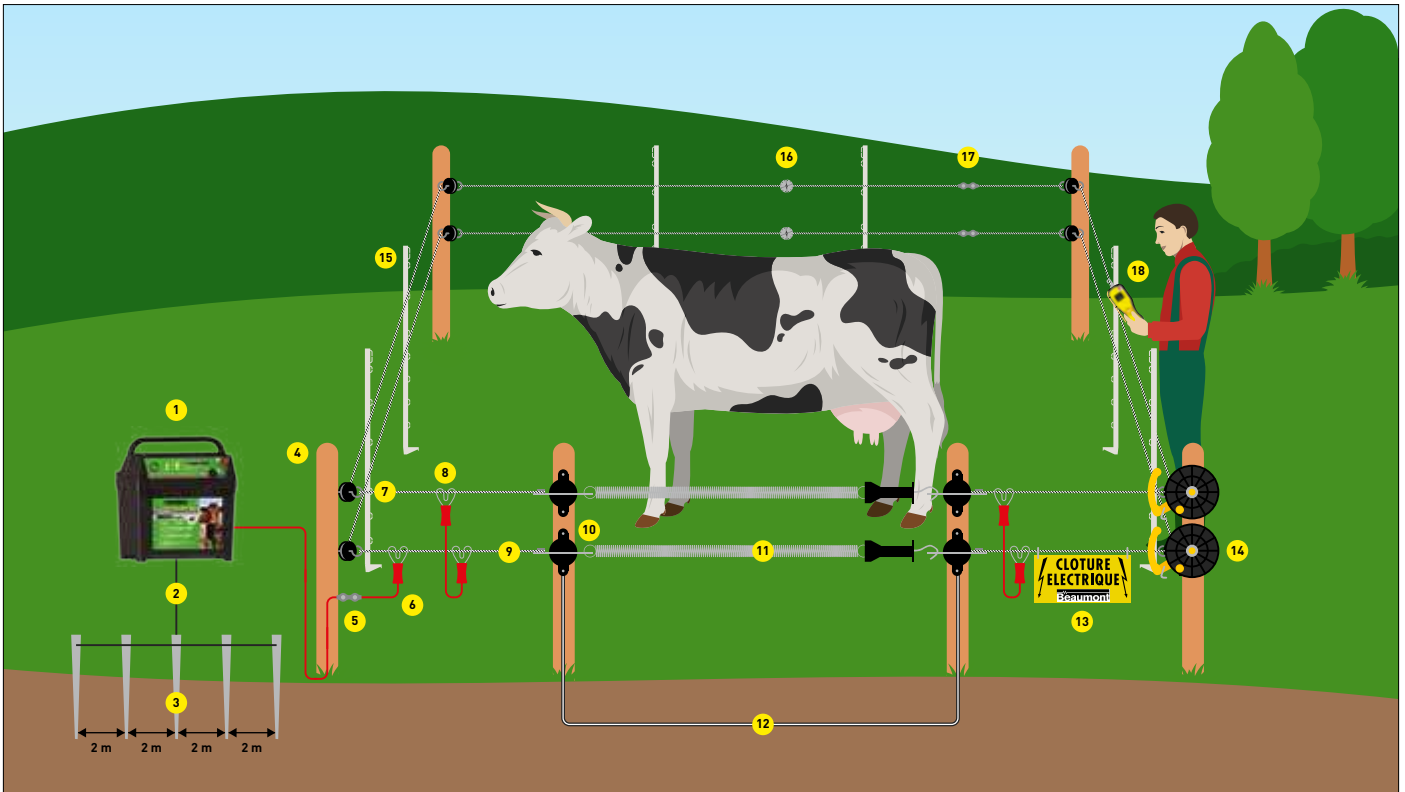

DIAGRAM OF MOBILE FENCING FOR COWS

- | | | |
|--------------------------|--------------------------------------|--------------------------|
| 1. Dual energizer | 7. Corner insulator for wire | 13. Warning sign |
| 2. Earthing wire | 8. Wire-to-wire connector | 14. Reel |
| 3. Earth rod | 9. Fence wire | 15. Plastic fence posts |
| 4. Wooden post | 10. Anchor insulator for wire | 16. Wire strainer |
| 5. Connector | 11. Gate kit with spring | 17. Connection for wire |
| 6. Fence connecting wire | 12. Direct-burial high-voltage cable | 18. Digital fence tester |

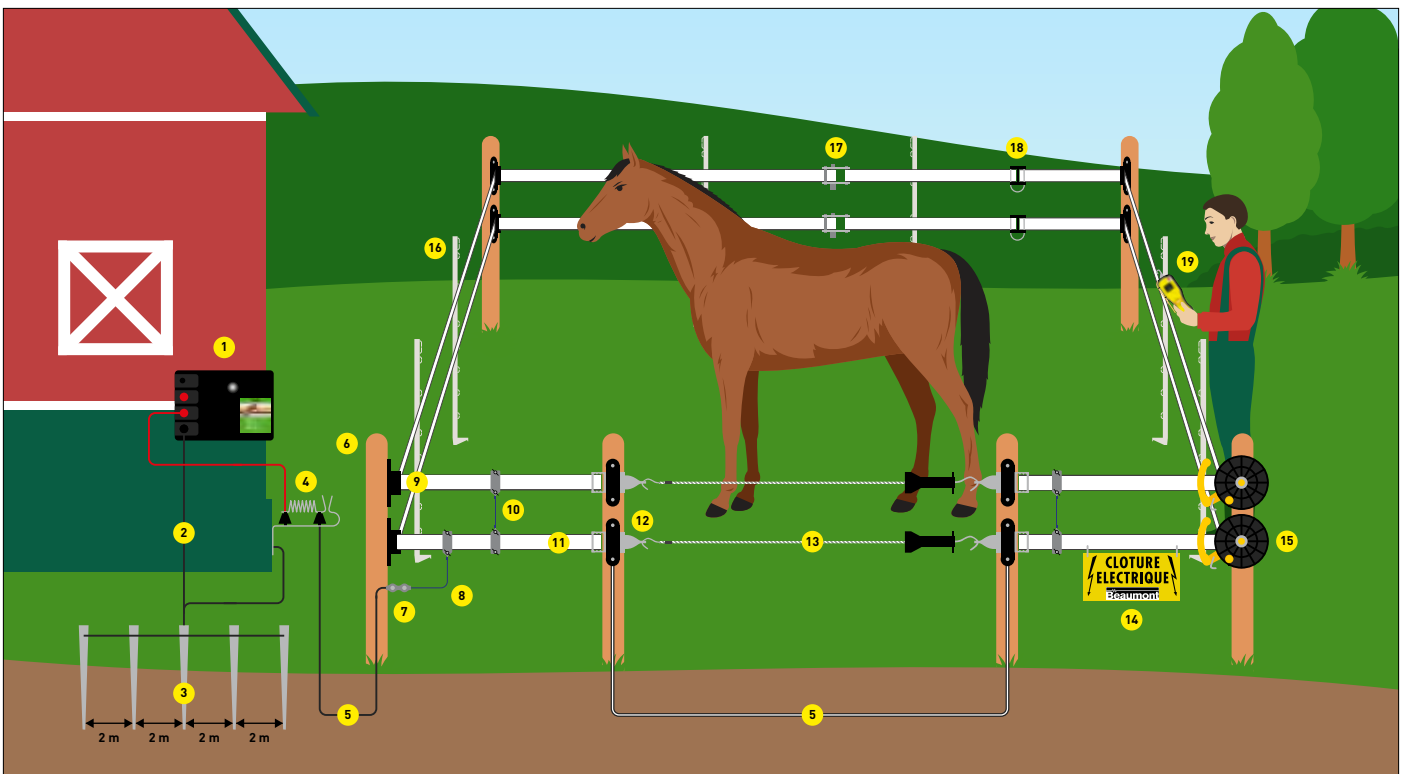

DIAGRAM OF MOBILE FENCING FOR HORSES

- | | | |
|-------------------------------------|--------------------------------|--------------------------|
| 1. Mains energizer | 8. Fence connecting wire | 15. Reel |
| 2. Earthing wire | 9. Corner insulator | 16. Plastic fence posts |
| 3. Earth rod | 10. Tape-to-tape connector | 17. Tape strainer |
| 4. Lightning conductor | 11. Fence tape | 18. Connection for tape |
| 5. Direct-burial high-voltage cable | 12. Anchor insulator | 19. Digital fence tester |
| 6. Wooden post | 13. Gate kit with elastic cord | |
| 7. Connector | 14. Warning sign | |

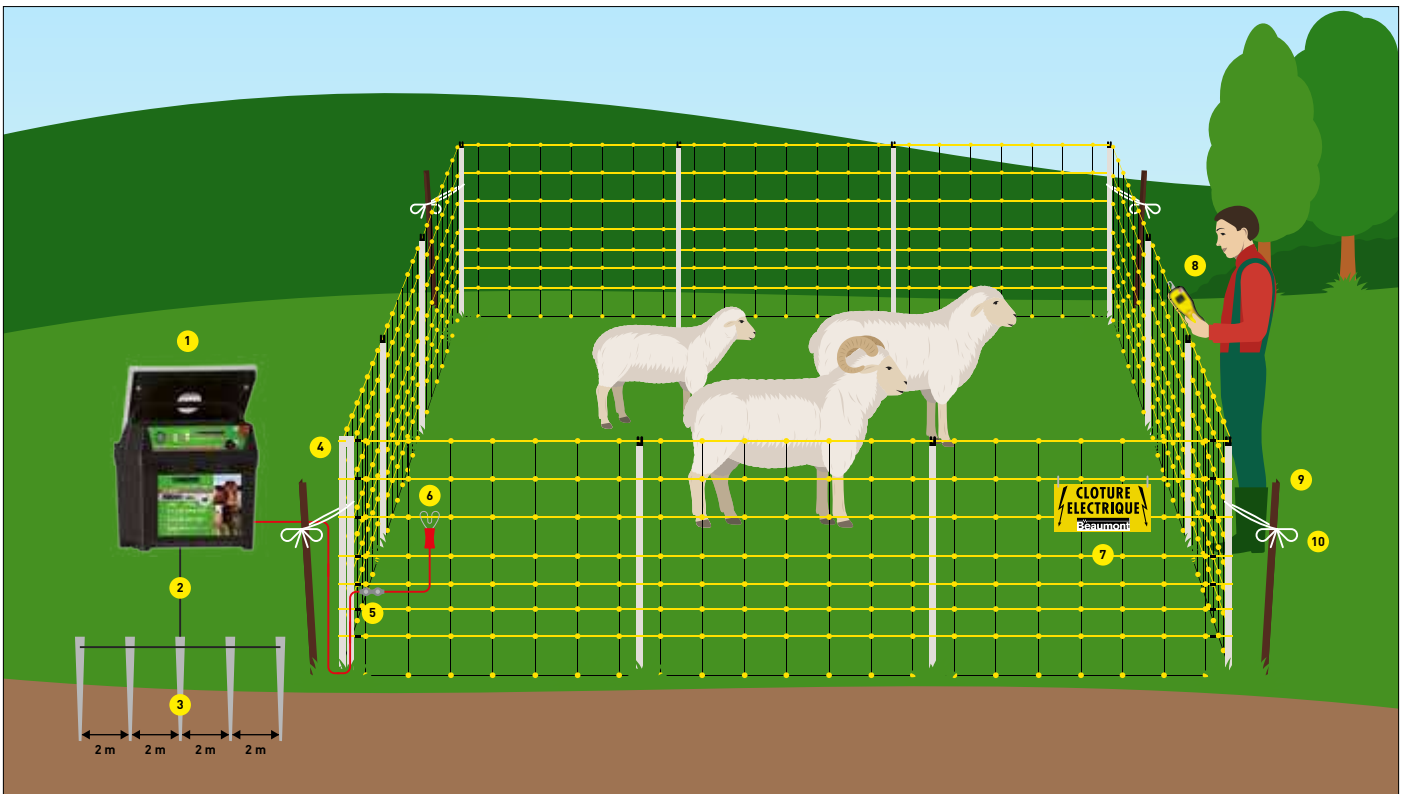

DIAGRAM OF MOBILE FENCING FOR SHEEP

- 1. Solar energizer
- 2. Earthing wire
- 3. Earth rod
- 4. Sheep net

- 5. Connector
- 6. Fence connecting wire
- 7. Warning sign
- 8. Digital fence tester

- 9. Corner post
- 10. Farmer rope

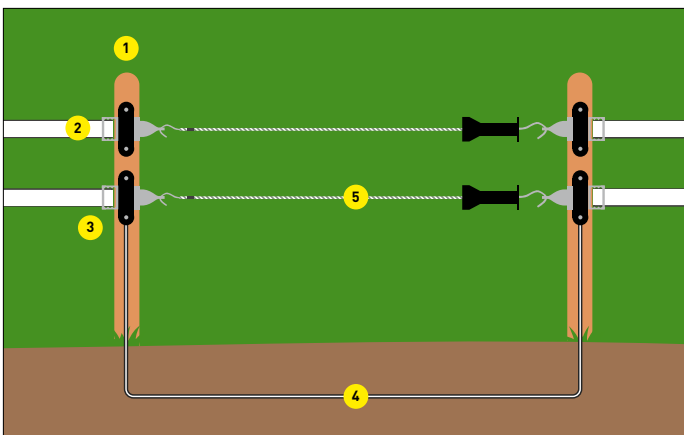
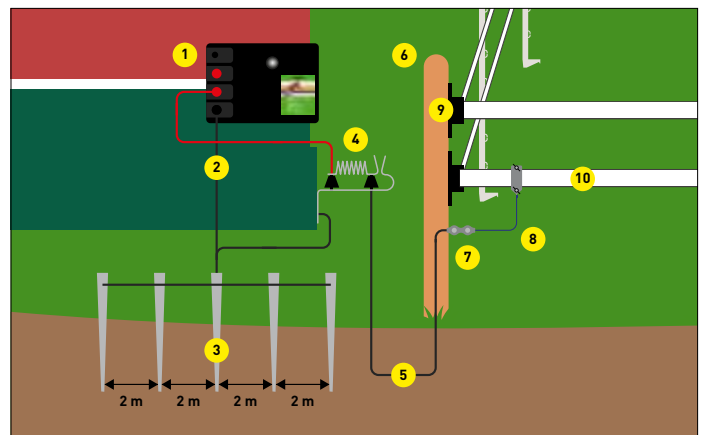

DIAGRAM OF GATE KIT

- 1. Wooden post
- 2. Fence tape
- 3. Anchor insulator
- 4. Direct-burial high-voltage cable

- 5. Gate kit with elastic cord



CONNECTION DIAGRAM FOR FENCE ENERGIZER

- 1. Mains energizer
- 2. Earthing wire
- 3. Earth rod
- 4. Lightning conductor
- 5. Direct-burial high-voltage cable

- 6. Wooden post
- 7. Connector
- 8. Fence connecting wire
- 9. Corner insulator
- 10. Fence tape



OUR ADVICE



TIP REGARDING THE BATTERY:

Take off the scotch tape to air the battery. Ideally, we recommend waiting a few minutes for the chemical reaction to take effect before activating the battery.

Place the battery in the energizer, making sure it is the right way round (red/red - black/black). Place some scotch tape back on the battery when storing it to extend its lifespan.

IN A FEW STEPS
ELEC
FENCING
CONDUCTORS
POSTES
DEVIS

"PLAN YOUR OWN MADE-TO-MEASURE ELECTRIC FENCING PROJECT!"



EASY



QUICK



EFFICIENT

MORE THAN
2000
COMBINATIONS!



OUR BRANDS:



DISCOVER OUR VIDEO!

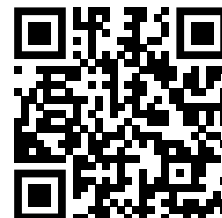

www.ukal-elevage.com/en/fencecalculator

UKAL    



UKAL

— HORIZONT FENCE

- 232 Energisers
- 272 Earthing & control
- 277 Netting
- 288 Conductor material
- 304 Posts
- 316 Insulators
- 326 Gates

FAQ

ENERGISERS

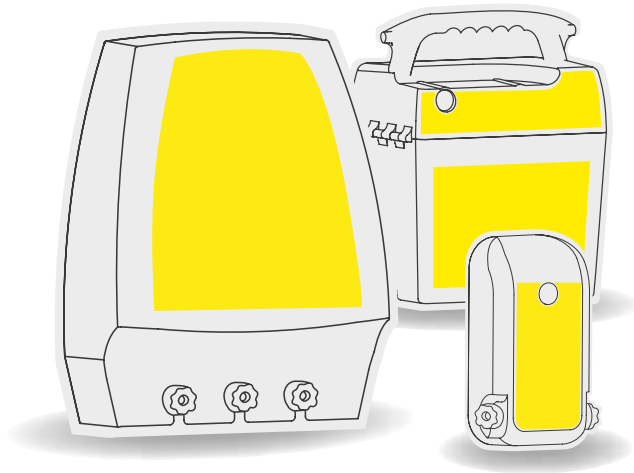

The horizont service for you:
All horizont energisers come with a two to five year warranty.

PREMIUM QUALITY
MADE IN GERMANY

All horizont energisers are produced in Germany which is why they are known for their **premium quality**.

WHAT DOES THE ENERGISER DO?

- The energiser emits short current pulses that flow along the fence and remain unused if there is no animal contact or discharge.
- The pulse duration is only 0.1 to 0.3 thousandths of a second and the pulse spacing is between 1,15 and 2,0 seconds.

WHY A CLOSED CIRCUIT?

The circuit must be prepared so that it is closed when it comes into contact with the animal. It is also important to ensure that the current remains in the fence and really only activates when it is touched by an animal.

WHAT IS EARTHING?

- Earthing is the "counterpart to the freely installed conductor material" in the fence.
- The energy emitted by the energiser is fed back into the energiser through the ground and the earth stakes. When the fence is touched, the circuit is closed via the earthing.

WHAT HAPPENS WHEN THE ANIMAL TOUCHES THE FENCE?

TIP: EARTHING WITH DRY GROUND

Earthing: The number of earth stakes refers to damp soil.
If the soil is dry in summer, the number may have to be increased.

- The animal closes the circuit. The pulse emitted by the electric fence energiser flows through the conductor material, the animal's body, the ground and the earth stakes back into the electric fence energiser. Similar to a light switch, the animal or vegetation closes the circuit and the energy flows.
- The animal learns to accept the fence as a barrier.

WHAT HAVE JOULES & VOLTS GOT TO DO WITH IT?

- Energy applied to the fence is expressed in joules. The higher the value, the stronger the electric shock. Joules hurt!
- The voltage of the fence is measured in volts. The voltage is needed to strike through the insulating hide of the animal. This is the only way the energy can jump over. Voltage is the carrier for what causes the pain!

WHY USE HIGH QUALITY CONDUCTOR MATERIAL?

- The conductive material is the actual fence, i.e. tapes, ropes, polywires or wires.
- The conductor material transports the electricity and forms the barrier for the animals. The better the material, the higher the current that flows through the fence.
- Saving on conductor material is to be penny-wise and pound-foolish. Poor conductor material may cause significant energy loss and prevent electricity from reaching the end of the fence. Never knot your conductor material! Too much energy is lost in the process. Always use suitable connectors to guarantee the current flow.

IS LONG GRASS AT THE FENCE A BAD THING?

- Yes, because grass or other vegetation diverts energy from the fence and the fence therefore loses energy.
- For vegetation, reduce the fence lengths as follows:

FOR AVERAGE VEGETATION:

To approx. 50 % of the specified fence length*

FOR DENSE VEGETATION:

To approx. 20 % of the specified fence length*

HOW FAR APART SHOULD THE POSTS BE?

To ensure the conductor material is optimally fixed between the posts, the following distances have been proven to be effective:

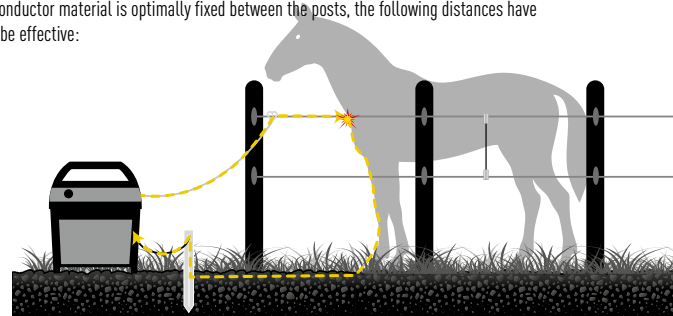

*Data for single and multi-wire fences

- **POLYWIRES AND WIRES:**
6 m to 8 m (depending on net weight)
- **TAPES:**
3 m (for wide tape 40 mm), 5 m (for wide tape 20 mm), 6 m to 8 m (for wide tape 10 mm)
- **ELECTRIC ROPE:**
4 m (for diameter 6 - 8 mm), 6 m (for diameter 5 - 6 mm)
- **TERRAIN:**
Observe the local conditions! If the terrain is very uneven, several posts are required to guide the conductor material parallel to the ground.

WHAT ELSE NEEDS TO BE CONSIDERED?

- **Important:** Never operate fence systems and netting without an energiser!
- **Conductivity:** Be sure to use conductor material with high conductivity and good earthing, especially for high pulse energies.
- **Connectors:** Never knot your conductor material - always use suitable connectors to guarantee the current flow.
- **Warning signs:** For safety reasons, you are legally obliged to attach these to your electric fence, clearly visible and printed on both sides.
- **Circuit:** The fence does not have to be set up as a closed circuit - the circuit is closed by the animal contact.
- **Daily check with fence testers**

TIP

But one thing must not be forgotten: The energiser is useless if it is connected to a defective fence!

HOW DOES AN ENERGISER WORK?

The energiser is supplied with power from the mains, a battery or a rechargeable battery (sometimes with solar support). When the energiser is earthed and connected to a fence, your circuit is not closed. If an animal now touches the fence, the electric circuit is closed by the animal: The current flows from the fence through the animal to the earth. To eliminate the risk of dangerous electric shock, the energiser sends the charge to the fence in pulses. A high voltage must be generated so that the current can flow over the animal on contact. The energy must also be "portioned" so that no dangerous current flows at the high voltage.

WHICH ADDITIONAL FUNCTIONS DO HORIZONT ENERGISERS OFFER?*

horizont energisers are equipped with various, sometimes automatic, functions. These guarantee simple and flexible adaptation to the respective type of use, fence quality and vegetation. Moreover, you can get by with fewer batteries throughout the entire electric fence season, as many energisers are equipped with a power economiser (ECO Power / power saving function).

The premium products are made of particularly stable and weather-resistant plastic. They are splash-proof protected, electrically well insulated and suitable for high operating temperatures in the sun. Some energisers have an LED display that provides information about the state of the fence despite being far away. The time spent on controlling is reduced to a minimum as the output voltage can be read directly on the energiser (Energy Control Power Control, Impulse Control, System Control).

There are also some features which ensure herding security in difficult situations in case of damage (2-stage CPN technology, turbomax technology).

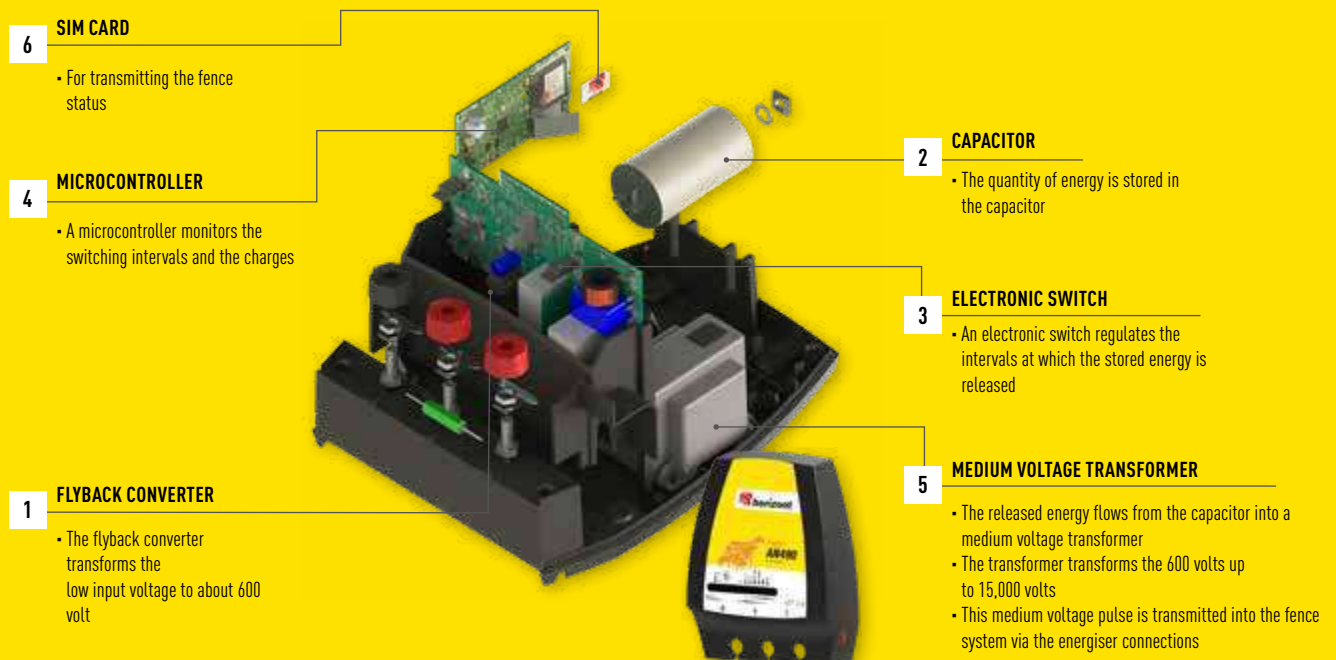

* The range of functions differs between the different types of housing and energy supply

THE CHOICE OF THE RIGHT ENERGISER

WHICH ENERGY SUPPLY IS PREFERRED?

horizont distinguishes between battery energisers 9 V, rechargeable battery energisers 12 V, mains energisers 230 V and solar energisers. Many energisers also combine different types of power supply in order to offer more security and flexibility in the application. In addition, horizont offers different housing shapes, which are reflected in the operating mode. The main difference is in stationary housing forms for wall mounting and mobile housing forms for handy transport.



Battery energiser
9 V



Battery energiser
12 V



Mains energiser
230 V



Solar energiser

HOW LARGE IS THE AREA TO BE FENCED?

The fence length is important for the choice of the right energiser, but so is the conductor material. The power of the energiser and the conductivity of the conductor material must be compatible! To simplify the choice of suitable products for you, horizont has grouped together matching products in series.

Please note that the length specifications always assume optimal conditions, any disruptions and growth are excluded. With vegetation, for example, a partial amount of energy is diverted from the fence into the ground and is then missing from the herding performance.

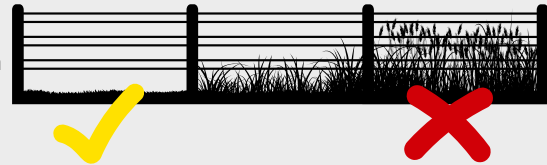

WHICH ANIMALS ARE TO BE HERDED?

Each animal has special characteristics and reacts differently to the current pulse. The sensitivity and coat of the animals is important for the correct construction of the electric fence. Horizont has developed special pulse shapes for different situations to ensure herding security for every animal species and every fence situation. The animal symbols make it easy to identify the energiser recommended for a particular animal species.

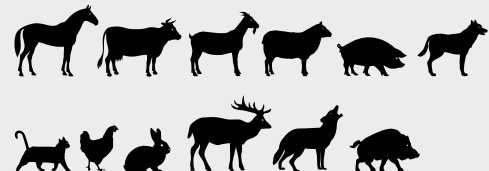

WHICH ADDITIONAL FUNCTIONS DO HORIZONT ENERGISERS OFFER?

Each energiser has individual features and additional functions that are advantageous depending on the application. Some are found in the housing shape, others are technically incorporated.



SAFE HANDLING OF ENERGISERS: PROTECTION AGAINST FIRE, BLAZE, AND LIGHTNING

The energiser must not be installed inside buildings in operating areas with a fire hazard, such as barns, and should also be protected from mechanical damage and kept out of the reach of children. To prevent lightning damage, a specialist must install an earthed lightning protection energiser in the fence supply cable to the building or prior to entry into a building.

You will find detailed information in our safety instructions: www.animalcare.horizont.com/Secura

ENERGY SUPPLY CLEVERLY COMBINED

Electrified non-stop!

The horizont DUAL energisers with Safety⁺

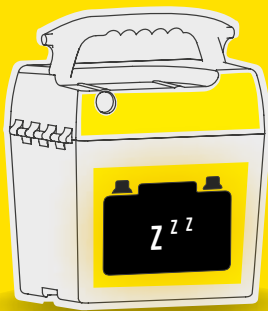

Regular 230 V operation.

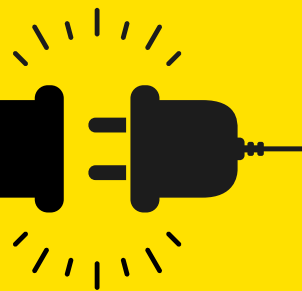

The power supply fails!

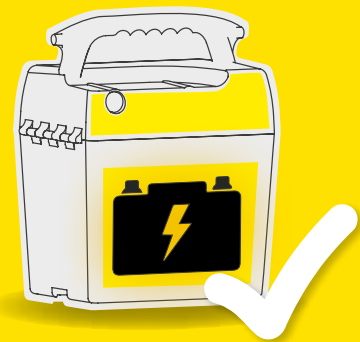

Automatic switch-over to 12 V battery operation.

DUAL



Can only be done by horizont energisers:

Automatic switch-over to battery operation in the event of an interruption in the power line.

Dual energisers are primarily operated via 12 volts or 9 volts. The energisers can also be connected to 230 V via a plug-in mains energiser. The 12 volt battery then serves as a backup battery and is charged via the plug-in power supply. If the 230 volt mains fails, the energisers continue to operate without interruption via the 9 or 12 V battery. The energisers can also be operated with a solar panel in conjunction with a 12 or a 9 volt battery.

COMBI



Combi energisers from the 12 V battery range can be operated on the 230 V mains or on the 12 V battery. Combi energisers from the battery range can be operated on the 12 volt battery or on a 9 volt battery. A solar panel can additionally be connected directly to the 12 V battery or to the 9 V battery via the energiser.

FROM HOBBY TO PROFESSIONAL

PRODUCT SERIES

The innovative series concept

The right product series for every application:

The horizont electric fence series covers all areas of application: From hobby to professional. The components of a series guarantee optimal interaction. Beginning with the entry-level series trapper® to the premium series turbomax® horizont offers the optimal solution for every area of application, whether cattle, horse, sheep/goat husbandry or small animal keeping.

Nearly all energisers are produced in Germany and undergo a multi-stage quality assurance

process during production, which is DIN EN ISO 9001 certified. This provides the greatest possible safety both in the use of individual components and for the finished product.

You will find the energiser features with explanations on the respective product in the catalogue.



trapper®

IDEAL FOR SMALL, SIMPLE FENCE SYSTEMS

Our trapper® series is very suitable for newcomers and hobby livestock owners. The trapper energisers are the ideal choice for small and simple fence systems.

- Simple to use, easy to install
- Compact housing, versatile in use
- Output energy designed for the most common applications, e.g. horse keeping

THE MOST IMPORTANT FEATURES*:

- ON /OFF switch
- Energy Control (display of battery/ rechargeable battery capacity)
- Very sturdy housing
- Power Control (pulse control)



farmer®

IDEAL FOR CALM GRAZING ANIMALS AND NORMAL OPERATING CONDITIONS

The farmer® range of energisers includes our all-rounders for electric fence management. They are ideal for calm grazing animals that are kept under normal operating conditions. This series also includes many energisers that have a dual function.

- Special pulse shape deploys gently in the fence system
- High output voltages offer great herding security

THE MOST IMPORTANT FEATURES*:

- Polycarbonate
- ON /OFF switch
- Energy Control (display of battery/ rechargeable battery capacity)
- ECO Power (power economiser)
- Very sturdy housing
- Power Control (pulse control)



* The range of functions differs between the different types of housing and energy supply.



hotshock®

IDEAL FOR ROBUST ANIMALS AND FOR WILDLIFE DETERRENT

This series is perfectly suited for deterring robust animals or the keeping of long-haired and feathered animals. hotshock® energisers can therefore be used for sheep and goat farming in combination with netting. They regulate every difficult situation, making them useful as special solutions in wildlife deterrent.

- Strong energisers with maximum output energy
- Special pulse shape enables special herding security under the most difficult conditions

THE MOST IMPORTANT FEATURES*:

- Polycarbonate
- ON /OFF switch
- Energy Control (display of battery/rechargeable battery capacity)
- ECO Power (power economiser)
- Impulse Control (cycle sequence monitoring)
- Very sturdy housing
- 2 fence terminals
- Power Control (pulse control)



ranger®

FOR EXACTING DEMANDS AND DRY SOIL CONDITIONS

Our professional series for exacting demands and dry location conditions. The ranger® energisers are ideal for grazing animals such as cattle or horses. This series also includes many energisers that have a dual function.

- Energiser function can be adapted to fence conditions depending on the situation
- Special pulse shape deploys gently in the fence system
- Large herding performance even during dry summer periods

THE MOST IMPORTANT FEATURES*:

- Polycarbonate
- ON /OFF switch
- System Control (argutector fence control)
- Energy Control (display of battery/rechargeable battery capacity)
- ECO Power (power economiser)
- 6-stage voltage display
- Impulse Control (cycle sequence monitoring)
- Very sturdy housing
- Voltage regulator (rotary potentiometer)
- 2 fence terminals
- 6 modes function



turbomax®

POWERFUL PERFORMANCE FOR HIGHEST DEMANDS

Our premium series for extreme and particularly high demands. The turbomax® energisers are extremely powerful energisers and are suitable for extremely long fences. turbomax energisers can be used for herding almost all types of animals.

- Important safety features and functions that are very useful for the user
- Special safety circuit, which increases the performance when required

THE MOST IMPORTANT FEATURES*:

- Polycarbonate
- ON /OFF switch
- System Control (argutector fence control)
- Energy Control (display of battery/rechargeable battery capacity)
- ECO Power (power economiser)
- 6-stage voltage display
- LED display
- Alarm function
- 2-stage CPN technology
- Impulse Control (cycle sequence monitoring)
- Very sturdy housing
- turbomax technology



* The range of functions differs between the different types of housing and energy supply.

PRODUCT GUIDE

ENERGISERS



BATTERY ENERGISERS 9 V















DUAL / COMBI	Number of possible nets per 50 m	As per CEE* GSE (1500V)	Without vegetation max.	Average vegetation max.	High vegetation max.	Animal husbandry						Wildlife deterrent		Product			
															Designation	Art. No.	
Combi	—	3 km	1.5 km	—	0.5	•				•						trapper® AB12	125H14497
Combi	—	4 km	3 km	1 km	0.3 km	•	•		•	•						trapper® B12	125H10616
Combi	—	8 km	5 km	3.5 km	0.8 km	•	•		•	•						trapper® B22	125H10620
Dual	2	9.5 km	5.5 km	3.8 km	0.9 km	•	•			•			•			farmer® ABN30	125H10891
Dual	3	10 km	6 km	4 km	1.1 km	•	•	•					•			hotshock® ABN37	125H10892
Dual	2	12 km	6.5 km	4.5 km	1.3 km	•	•			•			•			ranger® ABN60	125H10983



BATTERY ENERGISERS 12 V

Combi	3	8 km	4 km	2 km	0.8 km	•	•	•	•	•	•					trapper® AN45	125H10867
Combi	4	12 km	8 km	3.5 km	1.2 km	•	•	•	•	•	•					trapper® AN80	125H10866
Combi	6	18 km	12 km	4.5 km	1.5 km	•	•	•	•		•	•				trapper® AN120	125H10865
Dual	6	30 km	10 km	3.5 km	1.2 km	•	•	•	•	•			•			farmer® AN100	125H10896
Dual	12	80 km	18 km	4.8 km	1.9 km	•	•	•	•				•			farmer® AN300	125H10882
Dual	6	40 km	10 km	3.5 km	1.2 km	•	•	•	•				•			farmer® AN1000	125H10855
Dual	6	40 km	10 km	3.5 km	1.2 km	•	•	•	•				•			farmer® AN1000Solar	125H10856
—	14	80 km	30 km	15 km	8 km	•	•	•					•	•		hotshock® A300	125H10613
Combi	14	130 km	45 km	20 km	10 km	•	•	•					•	•		hotshock® AN490	125H10813
Dual	12	90 km	43 km	17 km	9 km	•	•	•	•	•			•	•		ranger® AN360	125H10997
Dual	14	130 km	60 km	20 km	10 km	•	•	•	•	•			•	•		ranger® AN490	125H10857
Dual	10	50 km	20 km	4.5 km	1.7 km	•	•	•					•			ranger® AN2000	125H10854
Dual	12	100 km	33 km	5 km	2 km	•	•	•	•				•	•		ranger® AN3000	125H10992
Dual	14	130 km	60 km	20 km	10 km	•	•	•	•				•	•		ranger® AN4800	125H10993
Dual	17	180 km	55 km	21 km	14 km	•	•	•					•	•		turbomax® AN800	125H10749

MAINS ENERGISERS 230 V

DUAL / COMBI	Number of possible nets per 50 m	As per  CEE (11000V)	Without vegetation  max.	Average vegetation  max.	High vegetation  max.	Animal husbandry								Wildlife deterrent		Product	
																Designation	Art. No.
—	3	15 km	4 km	2 km	0.8 km	•	•		•	•	•	•			trapper ® N45	125H10864	
—	10	50 km	15 km	4 km	1.4 km	•	•		•	•			•		farmer ® N200	125H10996	
—	16	120 km	45 km	20 km	10 km	•	•	•					•	•	hotshock ® N500	125H10614	
—	12	60 km	20 km	5 km	2 km	•	•		•	•			•		ranger ® N270	125H10608	
—	16	100 km	40 km	10 km	4 km	•	•		•	•			•		ranger ® N420	125H10742	
—	30	320 km	85 km	40 km	25 km	•	•	•		•			•		turbomax ® N1430	125H10748	

SOLAR ENERGISERS

—	—	8.5 km	5 km	3 km	0.9 km	•	•			•					trapper ® AS25	125H14982
—	—	18.5 km	5 km	3 km	0.9 km	•	•			•					farmer ® AS50	125H14485
—	8	48 km	14 km	5 km	1.5 km	•	•						•		farmer ® AS140	125H14478
Dual	6	43 km	12 km	4 km	1.4 km	•	•						•		ranger ® AS120	125H10986
Dual	8	48 km	14 km	4.3 km	1.6 km	•	•						•	•	ranger ® AS180	125H10987



125H15848



125H15844



125H14500



125H12012



125H14896

UKAL'S TIP

Our small and large batteries are designed to work with our battery-powered energisers. Alkaline batteries provide optimum voltage and are generally used with high performance batteries.



ALKALINE 9 V BATTERIES

- The best power to optimise your energiser's operation.
- 0 % mercury / 0 % cadmium.
- Resistant to extreme conditions: from -20° C to +45° C.
- Turbomax®: guaranteed efficiency.
- Storage life: approx. 2 years.
- Suitable for new-generation energisers.

Sku. 125H15848	AB55 - 55 Ah (l)11 x (H)11,5 x (L)16,5 cm	4 014803 158482	
Sku. 125H15844	AB120 - 120 Ah (l)11 x (H)11,5 x (L)16,5 cm	4 014803 158444	
Sku. 125H14500	AB130 - 130 Ah (l)12,5 x (H)16 x (L)19 cm	4 014803 145000	
Sku. 125H14500P	AB130 - 130 Ah (l)12,5 x (H)16 x (L)19 cm	4 014803 449702	
Sku. 125H12012	AB170 - 170 Ah (l)12,5 x (H)16 x (L)19 cm	4 014803 120120	
Sku. 125H12012P	AB170 - 170 Ah (l)12,5 x (H)16 x (L)19 cm	4 014803 436955	
Sku. 125H14896	AB200 - 200 Ah (l)12,5 x (H)16 x (L)19 cm	4 014803 148964	
Sku. 125H14896P	AB200 (l)12,5 x (H)16 x (L)19 cm	4 014803 464552	

SALINE 9 V BATTERY

- Very good storage life (2 years on average).
- Insensitive to humidity.
- Very good price / Ah ratio.
- High efficiency under 300 Ohm: 112 Ah.

Sku. 125H12010	SB130 - 130 Ah (l)24,6 x (H)17,5 x (L)19 cm	4 014803 120106	
-----------------------	--	-----------------	--

UKAL'S TIP

What does C20 or C100 mean when the capacity is indicated?

Depending on the acid level, a battery has a certain capacity. This is specified as a C value. C20 indicates the capacity of a battery discharged for 20 h (with current) at the discharge voltage C100 indicates the capacity with a discharge over 100 h at discharge voltage current.

Since a discharge battery discharge of more than 20 h results in a much higher current than a discharge of more than 100 h, the specification of capacity at C100 (standard capacity) is lower than that of C20.



125H14124



125H14894

12 V BATTERIES

- With carrying handle.
- Excellent storage life (2 years on average).
- Insensitive to humidity.
- Very good price/Ah ratio.
- High output at 300 Ohm: 112 Ah.

Sku. 125H14124	C20 - 63 Ah (l)24,6 x (H)17,5 x (L)19 cm	4 014803 141248	
Sku. 125H14894	C100 - 85 Ah (l)26,5 x (H)17,5 x (L)22,5 cm	4 014803 148940	



Battery energisers 9 V

Battery energisers are small and handy. This makes them particularly suitable for mobile use. They can be operated with a 9 volt battery or with a 12 volt lead-fleece battery. All battery energisers can also be expanded to solar operation with a solar panel.

The dual energisers can also be connected to the 230 volt mains. The battery energisers offer many possible uses. The maximum output energy of the battery energisers is limited by the performance of the batteries. The use of a lead-fleece battery allows greater energies to be realised.

But beware: 9 V Batteries cannot be recharged.

Once they are completely discharged, they must be disposed of properly.

Each horizon electric fence battery can be stored for up to two years without any significant loss of capacity.

There are two different battery versions: Alkaline batteries (air cells) and zinc-carbon batteries. Both versions are mercury- and cadmium-free and therefore environmentally friendly.

trapper[®] B Battery energiser 9 V



Integrated carrying handle

- Easy to move with one hand



Cable bushing

- Intelligent cable routing from inside the energiser to solar panel

Extremely robust housing

- Particularly impact-resistant housing through use of high-quality plastics (PC)
- Material is UV resistant, splash-proof and oil-resistant

Energy supply

Possibilities of energy supply for these energisers:



Features

- Very sturdy housing
- Power Control (pulse control)
- Automatic switch-over to solar operation
- Solar charging control installed in the energiser is weather protected – easy charging of different types of batteries
- Microprocessor control
- Tested and built according to the applicable EU directives and the safety standard EN60335-2-76 and DIN EN ISO 9001



Secure closing mechanism – pull energiser apart and remove cover



Housing serves as portable box and protects rechargeable battery / battery from effects of weather

Front view



ON/OFF switch & Power Control

- Shows the activity of the energiser
- Flashes in time with the pulse output

Rear view



Fence terminal

Earth terminal

trapper® B Battery energiser 9 V

COMBI

trapper® B12

trapper® B22



Max. fence length:



As per CEE: 4 km
Without vegetation: 3 km
Average vegetation: 1 km
High vegetation: 0.3 km

As per CEE: 8 km
Without vegetation: 5 km
Average vegetation: 3.5 km
High vegetation: 0.8 km

Type of animal husbandry:



Input:

• 0.18 J

• 0.3 J

Max. output:

• 0.12 J

• 0.22 J

Energy consumption:

• 9 V: 15 mA

• 9 V: 35 mA

• 12 V: 22 mA

• 12 V: 25 mA

Max. voltage:

• 8,500 V

• 9,000 V

Voltage 500 Ω:

• 1,500 V

• 2,200 V

Dimensions (L x W x H):

• 19.5 x 23.3 x 25.0 cm

• 19.5 x 23.3 x 25.0 cm

Scope of delivery:

• Energiser, earth stake (approx. 30 cm), fence and earth connecting cable

• Energiser, earth stake (approx. 30 cm), fence and earth connecting cable



Recommended accessories:

• 12 V lead-fleece battery with 12 Ah (125H15842) ≥ service life: 41 days* or 9 V alkaline battery with 120 Ah (125H15844E) ≥ service life: 333 days*
• Earth stake 1 x 1 m (125H140411)
• Solar panel 1 x 2 W (125H60140)

• 12 V lead-fleece battery with 12 Ah (125H15842) ≥ service life: 20 days* or 9 V alkaline battery with 120 Ah (125H15844E) ≥ service life: 143 days*
• Earth stake 1 x 1 m (125H140411)
• Solar panel 1 x 2 W (125H60140)

Selected accessories

Find matching accessories for your horizon energiser in the comprehensive horizon range here in the catalogue or on the horizon website under the corresponding article number.



12 V lead-fleece battery with 12 Ah (125H15842)



9 V alkaline battery with 120 Ah (125H15844E)



Solar panel 2 W (125H60140)

* The figures refer to a calculated use of 100 % of the stated capacity.

farmer® ABN Battery energiser 9 V



Ergonomic carrying handle

- Carrying comfort thanks to soft grip padding
- Easy to move with one hand

Holding device for solar panel

- Easy attachment of the solar panel to the holding device
- 4 different setting angles and a transport position of the solar panel possible

Extremely robust housing

- Particularly impact-resistant housing through use of high-quality plastics (PC)
- Material is UV resistant, splash-proof and oil-resistant
- Housing holds rechargeable batteries with a capacity up to 34 Ah and batteries up to 200 Ah

ON/OFF switch & Energy Control

- 3-stage LED control display for capacity and function of 9 or 12 V batteries
- Shows the activity of the energiser
- Flashes in time with the pulse output

Energy supply



Dual energiser with Safety*

Dual energisers can be connected in parallel to 230 V mains power and a 12 V battery. Uninterrupted operation is guaranteed in the event of a power failure! The energiser switches over automatically to battery operation.

Features

- Plug-in profile for earthing rod in housing
- Top and bottom part are connected by hinge
- Housing can be secured by padlock
- Retaining plate inside provides firm stability for 9 and 12 V batteries
- Multi-optional storage compartment for power supply unit when not in use
- Intelligent cable routing prevents pinched cables and runs from inside the energiser to the solar panel
- ECO Power / power saving function: the power economiser automatically adjusts power consumption to the status of the fence = less energy consumption, less environmental impact and lower costs
- Automatic switch-over to solar operation
- Solar charging control installed in the energiser is weather protected – easy charging of different types of rechargeable batteries
- Microprocessor control
- Tested and built according to the applicable EU directives and the safety standard EN60335-2-76 and DIN EN ISO 9001

Advantage:

2 in 1



Safety advice: In 230 V operation, the energiser and the power supply unit should and must be installed in a room protected from moisture.

DUAL

farmer® ABN30



Max. fence length:	Netting:	2 x 50 m
	As per CEE:	9.5 km
	Without vegetation:	5.5 km
	Average vegetation:	3.8 km
	High vegetation:	0.9 km

Animal husbandry:



Input:

- 0.4 J
- 0.3 J

Max. output:

- 9 V: 28 - 36 mA
- 12 V: 24 - 28 mA

Energy consumption:

- 10,000 V
- 3,200 V

Max. voltage:

Voltage 500 Ω:

- 17.5 x 24.8 x 31.9 cm

Dimensions (L x W x H):

Scope of delivery:

- Energiser, earth stake (double spike approx. 17 cm), fence and earth connecting cable

Art. No.	Unit	EAN
125H10891	1	4014803108913

Recommended accessories:

- 12 V lead-fleece battery with 34 Ah (125H14501) ≥ service life: 50-59 days* or 9 V alkaline battery with 150 Ah (125H14057E) ≥ service life: 173-223 days*
- 230 V power supply unit (125H47PSU0010FEU)
- Earth stake 1 x 1 m (125H140411)
- Solar panel 1 x 5 W (125H14499)

Selected accessories

Find matching accessories for your horizont energiser in the comprehensive horizont range here in the catalogue or on the horizont website under the corresponding article number.



12 V lead-fleece with 34 Ah (125H14501) and solar panel 5 W (125H14499)

hotshock® ABN Battery energiser 9 V



Ergonomic carrying handle

- Carrying comfort thanks to soft grip padding
- Easy to move with one hand

Holding device for solar panel

- Easy attachment of the solar panel to the holding device
- 4 different setting angles and a transport position of the solar panel possible



Extremely robust housing

- Particularly impact-resistant housing through use of high-quality plastics (PC)
- Material is UV resistant, splash-proof and oil-resistant
- Housing holds rechargeable batteries with a capacity up to 34 Ah and batteries up to 200 Ah

ON/OFF switch & Energy Control

- 3-stage LED control display for capacity and function of 9 or 12 V batteries
- Shows the activity of the energiser
- Flashes in time with the pulse output

Energy supply



Dual energiser with Safety*

Dual energisers can be connected in parallel to 230 V mains power and a 12 V battery. Uninterrupted operation is guaranteed in the event of a power failure! The energiser switches over automatically to battery operation.

Features

- Plug-in profile for earthing rod in housing
- Top and bottom part are connected by hinge
- Housing can be secured by padlock
- Retaining plate inside provides firm stability for 9 and 12 V batteries
- Multi-optional storage compartment for power supply unit when not in use
- Intelligent cable routing prevents pinched cables and runs from inside the energiser to the solar panel
- Automatic switch-over to solar operation
- Solar charging control installed in the energiser is weather protected – easy charging of different types of rechargeable batteries
- Microprocessor control
- Tested and built according to the applicable EU directives and the safety standard EN 60335-2-76 and DIN EN ISO 9001

Advantage:
2 in 1



Safety advice: In 230 V operation, the energiser and the power supply unit should and must be installed in a room protected from moisture.

* The figures refer to a calculated use of 100 % of the stated capacity.

DUAL

hotshock® ABN37



Max. fence length:	Netting:	3 x 50 m
	As per CEE:	10 km
	Without vegetation:	6 km
	Average vegetation:	4 km
	High vegetation:	1.1 km

Animal husbandry:

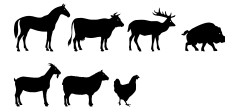

Input:

- 0.5 J

Max. output:

- 0.37 J

Energy consumption:

- 9 V: 47 mA
- 12 V: 35 mA

Max. voltage:

- 13,000 V

Voltage 500 Ω:

- 3,800 V

Dimensions (L x W x H):

- 17.5 x 24.8 x 31.9 cm

Scope of delivery:

- Energiser, earth stake (double tip approx. 17 cm), fence connection cable

Art. No.	Unit	EAN
125H10892	1	4 014803 108920

Recommended accessories:

- 12 V lead-fleece battery with 34 Ah (125H4501) ≥ service life: 40 days* or 9 V alkaline battery with 170 Ah (125H12012E) ≥ service life: 150 days*
- 230 V power supply unit (125H47PSU0010FEU)
- Earth stake 1 x 1 m (125H140411)
- Solar panel 1 x 10 W (125H14511)

Selected accessories

Find matching accessories for your horizon energiser in the comprehensive horizon catalogue or on the horizon website under the corresponding article number.



12 V lead-fleece with 34 Ah (125H4501) and solar panel 10 W (125H14511)

ranger® ABN



Ergonomic carrying handle

- Carrying comfort thanks to soft grip padding
- Easy to move with one hand

Holding device for solar panel

- Easy attachment of the solar panel to the holding device
- 4 different setting angles and a transport position of the solar panel possible



Extremely robust housing

- Particularly impact-resistant housing through use of high-quality plastics (PC)
- Material is UV resistant, splash-proof and oil-resistant
- Housing holds rechargeable batteries with a capacity up to 34 Ah and batteries up to 200 Ah

ON/OFF switch & Energy Control

- 3-stage LED control display for capacity and function of 9 or 12 V batteries
- Shows the activity of the energiser
- Flashes in time with the pulse output

Energy supply



Dual energiser with Safety*

Dual energisers can be connected in parallel to 230 V mains power and a 12 V battery. Uninterrupted operation is guaranteed in the event of a power failure! The energiser switches over automatically to battery operation.

Features

- Plug-in profile for earthing rod in housing
- Top and bottom part are connected by hinge
- Exhaustive discharge cut-off at 12 V
- Housing can be secured by padlock
- Retaining plate inside provides firm stability for 9 and 12 V batteries
- Multi-optional storage compartment for power supply unit when not in use
- Intelligent cable routing prevents pinched cables and runs from inside the energiser to the solar panel
- ECO Power / power saving function: the power economiser automatically adjusts power consumption to the status of the fence = less energy consumption, less environmental impact and lower costs
- Automatic switch-over to solar operation
- Solar charging control installed in the energiser is weather protected – easy charging of different types of rechargeable batteries
- Microprocessor control
- Tested and built according to the applicable EU directives and the safety standard EN60335-2-76 and DIN EN ISO 9001



Safety advice: In 230 V operation, the energiser and the power supply unit should and must be installed in a room protected from moisture.

DUAL

ranger® ABN60



Max. fence length:	Netting:	2 x 50 m
	As per CEE:	12 km
	Without vegetation:	6.5 km
	Average vegetation:	4.5 km
	High vegetation:	1.3 km

Animal husbandry:



Input:

- 0.65 J
- 0.6 J

Max. output:

Energy consumption:

- 9 V: 19 - 57 mA
- 12 V: 22 - 70 mA

Max. voltage:

Voltage 500 Ω:

- 11,000 V
- 3,600 V

Dimensions (L x W x H):

- 17.5 x 24.8 x 31.9 cm

Scope of delivery:

- Energiser, earth stake (double spike approx. 17 cm), fence and earth connecting cable

Art. No.	Unit	EAN
125H10983	1	4 014803 461001

Recommended accessories:

- 12 V lead-fleece battery with 34 Ah (125H14501) ≥ service life: 20-64 days* or 9 V alkaline battery with 170 Ah (125H12012E) ≥ service life: 173-223 days*
- 230 V power supply unit (125H47PSU0010FEU)
- Earth stake 1 x 1 m (125H140411)
- Solar panel 1 x 10 W (125H14511)

Selected accessories

Find matching accessories for your horizon energiser in the comprehensive horizon range here in the catalogue or on the horizon website under the corresponding article number.



12 V lead-fleece battery with 34 Ah (125H14501), 9 V alkaline battery with 170 Ah (125H12012E) and solar panel 10 W (125H14511)

TIP

Charge your special or lead-fleece battery only with regulated chargers to guarantee a long service life and make sure that the battery is well ventilated.



Battery energisers 12 V

Large fence systems can be operated using battery energisers.

High-capacity batteries can be used to extract so much energy that the turbomax® AN800, for example, can deliver a powerful 8 joules of output energy to the fence.

All batteries can be connected to a solar panel to avoid recharging from the mains if there is sufficient sunlight.

Energisers that can accommodate a battery in the housing also have a solar regulator installed in the energiser. The advantage of this housing shape is that the energiser, battery and solar panel form a compact unit.

trapper®  Battery energisers 12 V



Power Control

- Shows the activity of the energiser
- Flashes in time with the pulse output

Hanging device for wall mounting



Input socket

- For connection to 12 V or 230 V

Earth terminal

Fence terminal

Handy housing

- Particularly impact-resistant housing through use of high-quality ABS plastics (PC and PP)
- Material is UV resistant, splash-proof and oil-resistant

Energy supply

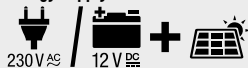

Combi energisers

Advantage: 2 in 1! Combi energisers can be operated either on 230 V mains power or on a 12 V battery.

Features

- Very sturdy housing
- Power Control (pulse control)
- Automatic switch-over to solar operation
- Microprocessor control
- Tested and built according to the applicable EU directives and the safety standard EN60335-2-76 and DIN EN ISO 9001

Advantage:

2 in 1



Safety advice: In 230 V operation, the energiser and the power supply unit should and must be installed in a room protected from moisture.

Battery energisers 12 V

COMBI

trapper® AN45

trapper® AN80

trapper® AN120



Max. fence length:



Netting: 3 x 50 m
As per CEE: 8 km
Without vegetation: 4 km
Average vegetation: 2 km
High vegetation: 0.8 km

Netting: 4 x 50 m
As per CEE: 12 km
Without vegetation: 8 km
Average vegetation: 3.5 km
High vegetation: 1.2 km

Netting: 6 x 50 m
As per CEE: 18 km
Without vegetation: 12 km
Average vegetation: 4.5 km
High vegetation: 1.5 km

Animal husbandry:



Input:

Max. output:

Energy consumption:

Max. voltage:

Voltage 500 Ω:

Dimensions (L x W x H):

Scope of delivery:

- 0.8 J
- 0.45 J
- 50 mA
- 7,900 V
- 3,300 V
- 5.8 x 12.4 x 17.2 cm
- Energiser, power supply unit, fence, earth and battery connecting cable

- 1.2 J
- 0.8 J
- 90 mA
- 8,400 V
- 3,600 V
- 5.8 x 12.4 x 17.2 cm
- Energiser, fence, earth and battery connecting cable

- 2.4 J
- 1.2 J
- 145 mA
- 8,600 V
- 4,000 V
- 5.8 x 12.4 x 17.2 cm
- Energiser, power supply unit, fence, earth and battery connecting cable

Art. No. Unit EAN
125H10867 1 4 014803 108678

Art. No. Unit EAN
125H10866 1 4 014803 108661

Art. No. Unit EAN
125H10865 1 4 014803 108654

Recommended accessories:

- 12 V AGM battery with 60 Ah (125H14548) ≥ service life: 52 days*
- Earth stake 1 x 1 m (125H140411)
- Solar panel 1 x 10 W (125H14545)

- 12 V AGM battery with 60 Ah (125H14548) ≥ service life: 40 days*
- Earth stake 1 x 1 m (125H140411)
- Solar panel 1 x 10 W (125H14545) or 1 x 20 W (125H14536)

- 12 V battery special with 100 Ah (125H14126) ≥ service life: 29 days*
- Earth stake 2 x 1 m (125H140411)
- Solar panel 1 x 20 W (125H14536) or 1 x 20 W (125H14536)

Selected accessories

Find matching accessories for your horizon energiser in the comprehensive horizon range here in the catalogue or on the horizon website under the corresponding article number.



12 V AGM battery with 60 Ah (125H14548)

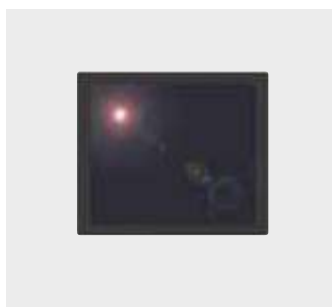

Solar panel 10 W (125H14545)



Solar panel 20 W (125H14536)

* The figures refer to a calculated use of 100 % of the stated capacity.

farmer® **12V_{DC} Battery energisers 12 V**



Extremely robust housing

- Particularly impact-resistant housing through use of high-quality plastics (PC)
- Material is UV resistant, splash-proof and oil-resistant

Energy Control

- 3-stage LED control display for capacity and function of rechargeable battery
- Shows the activity of the energiser
- Flashes in time with the pulse output

Earth terminal

Fence terminal

Energy supply



Dual energiser with Safety*

Dual energisers can be connected in parallel to 230 V mains power and a 12 V battery. Uninterrupted operation is guaranteed in the event of a power failure! The energiser switches over automatically to battery operation.

Features

- ECO Power / power saving circuit: The power economiser automatically adjusts power consumption to the status of the fence = less energy consumption, less environmental impact and lower costs
- Automatic switch-over to solar operation
- Microprocessor control
- Tested and built according to the applicable EU directives and the safety standard EN60335-2-76 and DIN EN ISO 9001



Hanging device for wall mounting



Ventilation slots to allow discharge of condensation water



Connection socket for the power supply unit at the back

Safety advice: In 230 V operation, the energiser and the power supply unit should and must be installed in a room protected from moisture.

DUAL

farmer® AN100



farmer® AN300



Max. fence length:



Netting:	6 x 50 m
As per CEE:	30 km
Without vegetation:	10 km
Average vegetation:	3.5 km
High vegetation:	1.2 km

Netting:	12 x 50 m
As per CEE:	80 km
Without vegetation:	18 km
Average vegetation:	4.8 km
High vegetation:	1.9 km

Animal husbandry:



Input:

• 1.3 J

Max. output:

• 1 J

Energy consumption:

• 30 - 90 mA

Max. voltage:

• 11,500 V

Voltage 500 Ω:

• 4,200 V

Dimensions (L x W x H):

• 9.0 x 19.0 x 23.3 cm

Scope of delivery:

• Energiser, power supply unit, fence and earth connecting cable

• 4.2 J

• 3 J

• 30 - 265 mA

• 11,800 V

• 6,200 V

• 9.0 x 19.0 x 23.3 cm

• Energiser, power supply unit, fence and earth connecting cable

Art. No.	Unit	EAN
125H10896	1	4 014803 108968

Art. No.	Unit	EAN
125H10882	1	4 014803 464163

Recommended accessories:

- 12 V AGM battery 88 Ah (125H14549) ≥ service life: 40-122 days*
- 230 V power supply unit (125H47PSU0010EU)
- Earth stake 1 x 1 m (125H140411)
- Solar panel 1 x 20 W (125H14536)

- 12 V battery special with 100 Ah (125H14126) ≥ service life: 16-138 days*
- 230 V power supply unit (125H47PSU0010EU)
- Earth stake 3 x 1 m (125H140411)
- Solar panel 1 x 30 W (125H14537)

Selected accessories

Find matching accessories for your horizon energiser in the comprehensive horizon range here in the catalogue or on the horizon website under the corresponding article number.



12 V battery special with 100 Ah (125H14126)

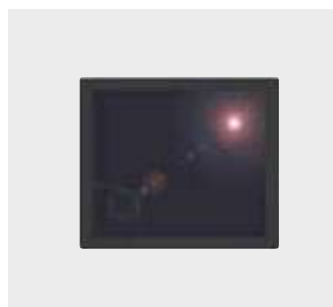

Solar panel 20 W (125H14536)

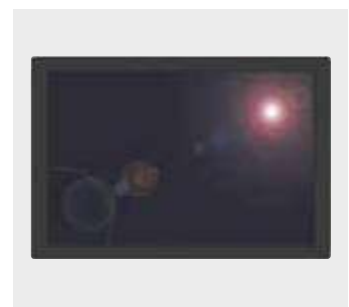

Solar panel 30 W (125H14537)

* The figures refer to a calculated use of 100 % of the stated capacity.

farmer® Battery energisers 12 V



ON/OFF switch & Energy Control

- 3-stage LED control display for capacity and function of 9 or 12 V batteries
- Shows the activity of the energiser
- Flashes in time with the pulse output

Ergonomic portable handle

- Carrying comfort thanks to soft grip padding
- Easy to move with one hand

Extremely robust housing

- Particularly impact-resistant housing through use of high-quality plastics (PC and PP)
- Material is UV resistant, splash-proof and oil-resistant
- Housing holds 9 and 12 V batteries up to a size of 265 x 192 x 225 mm



Rear view



Fence terminal

Earth terminal

Energy supply



Dual energiser with Safety*

Dual energisers can be connected in parallel to 230 V mains power and a 12 V battery. Uninterrupted operation is guaranteed in the event of a power failure! The energiser switches over automatically to 12 V battery operation.

Features

- ECO Power / power saving function: the power economiser automatically adjusts power consumption to the status of the fence = less energy consumption, less environmental impact and lower costs
- Rechargeable battery or battery is integrated into the handy transport box where it is protected from the weather
- Contact with the battery or the acid is avoided during transport
- Automatic switch-over to solar operation
- Solar charging control installed in the energiser is weather protected – easy charging of different types of rechargeable batteries
- Microprocessor control
- Tested and built according to the applicable EU directives and the safety standard EN60335-2-76 and DIN EN ISO 900



Housing can be secured by padlock



Device for attachment of appropriate solar panel to the back of the energiser cover



Solar panel can be folded away to the side for transport

Safety advice: In 230 V operation, the energiser and the power supply unit should and must be installed in a room protected from moisture.

DUAL

farmer® AN1000

farmer® AN1000Solar



Max. fence length:



Netting:	6 x 50 m
As per CEE:	40 km
Without vegetation:	10 km
Average vegetation:	3.5 km
High vegetation:	1.2 km

Netting:	6 x 50 m
As per CEE:	40 km
Without vegetation:	10 km
Average vegetation:	3.5 km
High vegetation:	1.2 km

Animal husbandry:



Input:

• 1.4 J

• 1.4 J

Max. output:

• 1 J

• 1 J

Energy consumption:

• 9 V: 40 - 70 mA

• 9 V: 40 - 70 mA

• 12 V: 30 - 90 mA

• 12 V: 30 - 90 mA

Max. voltage:

• 11,000 V

• 11,000 V

Voltage 500 Ω:

• 4,800 V

• 4,800 V

Dimensions (L x W x H):

• 24.0 x 31.5 x 38.0 cm

• 24.0 x 31.5 x 38.0 cm

Scope of delivery:

• Energiser, fence, earth and battery connecting cable

• Energiser, fence, earth connecting cable, 10 W solar panel

Art. No.	Unit	EAN
125H10855	1	4 014803 108555

Art. No.	Unit	EAN
125H10856	1	4 014803 108562

Recommended accessories:

- 12 V battery special with 60 Ah (125H14548) ≥ service life: 39-118 days* or 12 V lead-fleece battery with 75 Ah (125H14479, 26) ≥ service life: 34-104 days*
- 230 V power supply unit (125H47PSU0010FEU)
- Earth stake 1 x 1 m (125H140411)
- Solar panel 1 x 10 W (125H14546)

- 12 V battery special with 60 Ah (125H14548) ≥ service life: 39-118 days* or 12 V lead-fleece battery with 75 Ah (125H14479) ≥ service life: 34-104 days*
- 230 V power supply unit (47PSU0010FEU)
- Earth stake 1 x 1 m (125H140411)

Selected accessories

Find matching accessories for your horizon energiser in the comprehensive horizon range here in the catalogue or on the horizon website under the corresponding article number.



12 V battery special with 60 Ah (125H14548)



12 V lead-fleece battery with 75 Ah (125H14479)



Solar panel 10 W with bracket (125H14546)

* The figures refer to a calculated use of 100 % of the stated capacity.

hotshock® Battery energisers 12 V

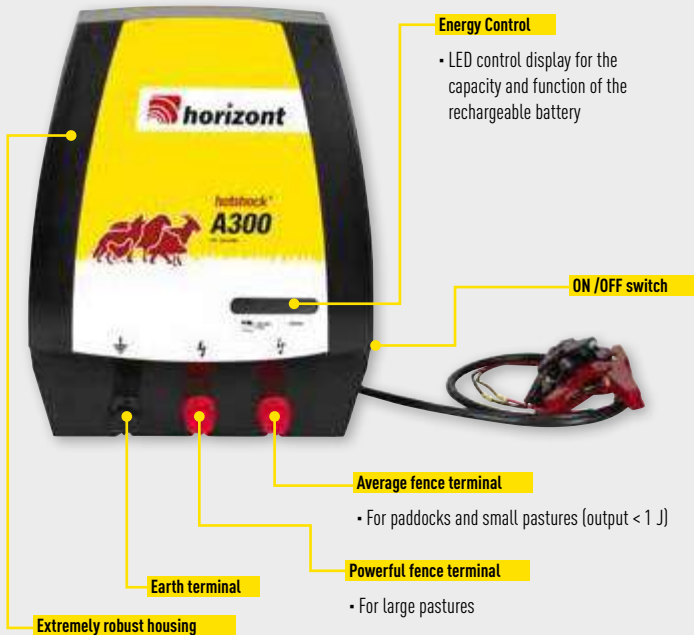

Extremely robust housing

- Particularly impact-resistant housing through use of high-quality plastics (PC)
- Material is UV resistant, splash-proof and oil-resistant

Energy supply



Features

- Two fence terminals for operating one large and one small pasture or paddock
- Automatic switch-over to solar operation
- Tested and built according to the applicable EU directives and the safety standard EN60335-2-76 and DIN EN ISO 9001



Hanging device for wall mounting



Ventilation slots to allow discharge of condensation water

Safety advice: In 230 V operation, the energiser and the power supply unit should and must be installed in a room protected from moisture.

hotshock® A300



Max. fence length:	Netting:	14 x 50 m
	As per CEE:	80 km
	Without vegetation:	30 km
	Average vegetation:	15 km
	High vegetation:	8 km

Animal husbandry:



Input:

- 4 J

Max. output:

- 3 J

Energy consumption:

- 340 mA

Max. voltage:

- 11,000 V

Voltage 500 Ω:

- 5,800 V

Dimensions (L x W x H):

- 9.9 x 22.8 x 28.4 cm

Scope of delivery:

- Energiser, fence, earth and battery connecting cable

Art. No.	Unit	EAN
125H10613	1	4 014803 006486

Recommended accessories:

- 12 V battery special with 100 Ah (125H14126) ≥ service life: 12 days*
- Earth stake 3 x 1 m (125H140411)
- Solar panel 1 x 20 W (125H14536) or 1 x 30 W (125H14537)

Selected accessories

Find matching accessories for your horizon energiser in the comprehensive horizon range here in the catalogue or on the horizon website under the corresponding article number.

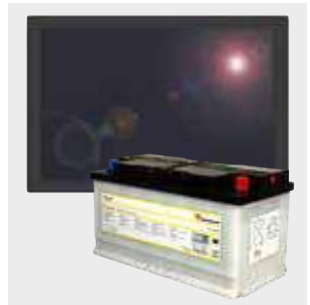

12 V battery special with 100 Ah (125H14126) and solar panel 30 W (125H14537)

hotshock® ^{12V} Battery energisers 12 V



Extremely robust housing

- Particularly impact-resistant housing through use of high-quality plastics (PC)
- Material is UV resistant, splash-proof and oil-resistant



ON / OFF switch

Earth terminal

Powerful fence terminal

Average fence terminal

- For paddocks and small pastures (output < 1 J)

- For large pastures

Control bar

- **Energy Control:** 3-stage LED control display for capacity and function of 9 or 12 V batteries
- **Impulse Control (cycle sequence monitoring):** Lights up when the device is in disrupted operation
- **System Control (argutector display):** Display at higher power consumption to maintain power
- **Voltage display:** 6-step LED display to check the fence voltage



Energy supply

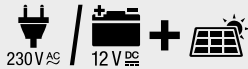

Features

- Two fence terminals for operating one large and one small pasture or paddock
- Connection socket for the power supply unit at the back
- Straightforward and visual information display – easy remote monitoring possible
- Exhaustive discharge cut-off at 12 V
- ECO Power / power saving function: the power economiser automatically adjusts power consumption to the status of the fence = less energy consumption, less environmental impact and lower costs
- Automatic switch-over to solar operation
- Microprocessor control
- Tested and built according to the applicable EU Directives and the safety standard EN60335-2-76 and DIN EN ISO 9001



Hanging device for wall mounting



Ventilation slots to allow discharge of condensation water

Safety advice: In 230 V operation, the energiser and the power supply unit should and must be installed in a room protected from moisture.

COMBI

hotshock® AN490



Max. fence length:	Netting:	14 x 50 m
	As per CEE:	130 km
	Without vegetation:	45 km
	Average vegetation:	20 km
	High vegetation:	10 km

Animal husbandry:



Input:

- 5.9 J

Max. output:

- 4.9 J

Energy consumption:

- 110 - 435 mA

Max. voltage:

- 14,000 V

Voltage 500 Ω:

- 6,000 V

Dimensions (L x W x H):

- 9.9 x 22.8 x 28.4 cm

Scope of delivery:

- Energiser, power supply unit, fence, earth and battery connecting cable

Art. No.	Unit	EAN
125H10813	1	4 014803 460998

Recommended accessories:

- 12 V battery special with 100 Ah (125H14126) ≥ service life: 9-44 days*
- Earth stake 3 x 1.5 m (125H15017-1)
- Solar panel 1 x 50 W (125H14873)

ranger[®] **12V^{BS}** Battery energisers 12 V



6 modes functions

1. **NORMAL:** Normal pulse sequence
2. **SMART:** Normal pulse sequence APN*
3. **DAY MODE:** Normal pulse sequence APN* by day, slow pulse sequence at night
4. **NIGHT MODE:** Normal pulse sequence APN* at night, slow pulse sequence by day
5. **SLOW MODE:** Slow pulse sequence APN* by day and at night
6. **ONLY NIGHT MODE:** Normal pulse sequence APN* at night, no pulse sequence by day
= additional energy savings, more efficiency, lower operating costs

Extremely robust housing

- Particularly impact-resistant housing through use of high-quality plastics (PC)
- Material is UV resistant, splash-proof and oil-resistant



ON /OFF switch & Menu pushbutton



LED control display

- **Energy Control:** 3-stage LED control display for capacity and function of 9 or 12 V batteries
- **Impulse Control (cycle sequence monitoring):** Lights up when the energiser is in disrupted operation
- **System Control (argutector display):** Display at higher power consumption to maintain power
- **Voltage display:** 6-step LED display to check the fence voltage

Average fence terminal

- For paddocks and small pastures (output < 1 J)

Powerful fence terminal

- For large pastures

Earth terminal

Energy supply



Dual energiser with Safety*

Dual energisers can be connected in parallel to 230 V mains power and a 12 V battery. Uninterrupted operation is guaranteed in the event of a power failure! The energiser switches over automatically to battery operation.

Features

- Two fence terminals for operating one large and one small pasture or paddock
- Connection socket for the power supply unit at the back
- Straightforward and visual information display – easy remote monitoring possible
- Exhaustive discharge cut-off
- ECO Power / power saving function: the power economiser automatically adjusts power consumption to the status of the fence = less energy consumption, less environmental impact and lower costs
- Automatic switch-over to solar operation
- Microprocessor control
- Tested and built according to the applicable EU directives and the safety standard EN60335-2-76 and DIN EN ISO 9001

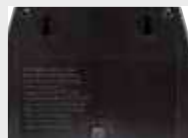

Hanging device for wall mounting



Ventilation slots to allow discharge of condensation water

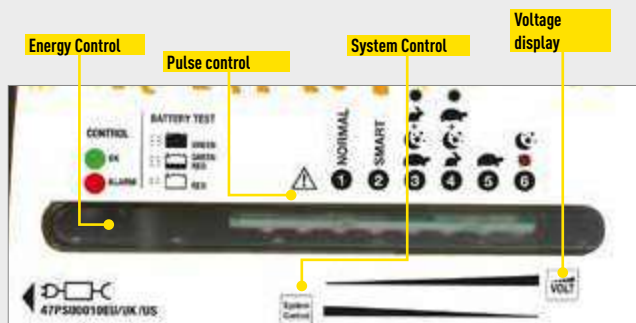

Safety advice: In 230 V operation, the energiser and the power supply unit should and must be installed in a room protected from moisture.

*APN = Output energy level is set to 60 % of the maximum energy and automatically adjusted in case of load changes, e.g. due to vegetation along the fence

DUAL

ranger® AN360

ranger® AN490



Max. fence length:

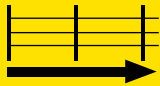

Netting:	12 x 50 m
As per CEE:	90 km
Without vegetation:	43 km
Average vegetation:	17 km
High vegetation:	9 km

Netting:	14 x 50 m
As per CEE:	130 km
Without vegetation:	60 km
Average vegetation:	20 km
High vegetation:	10 km

Animal husbandry:



Input:

Max. output:

Energy consumption:

Max. voltage:

Voltage 500 Ω:

Dimensions (L x W x H):

Scope of delivery:

- 4.3 J
- 3.6 J
- 70 - 320 mA
- 12,000 V
- 5,200 V
- 9.9 x 22.8 x 28.4 cm
- Energiser, power supply unit, fence, earth and battery connecting cable

- 5.7 J
- 4.9 J
- 70 - 450 mA
- 12,000 V
- 5,200 V
- 9.9 x 22.8 x 28.4 cm
- Energiser, power supply unit, fence, earth and battery connecting cable



Recommended accessories:

- 12 V special battery with 100 Ah (125H14126) ≥ service life: 13-46 days*
- Earth stake 2 x 1.5 m (125H15017-1)
- Solar panel 1 x 30 W (125H14537)

- 12 V battery special with 100 Ah (125H14126) ≥ service life: 9-44 days*
- Earth stake 3 x 1.5 m (125H15017-1)
- Solar panel 1 x 50 W (125H14873)

Selected accessories

Find matching accessories for your horizon energiser in the comprehensive horizon range here in the catalogue or on the horizon website under the corresponding article number.



12 V battery special with 100 Ah (125H14126)

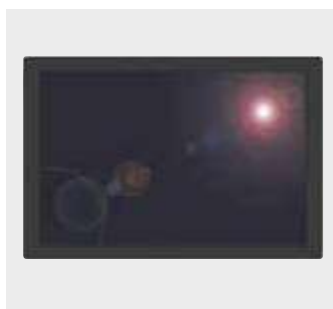

Solar panel 30 W (125H14537)



Solar panel 50 W (125H14873)

* The figures refer to a calculated use of 100 % of the stated capacity.

ranger® 12V_{BS} Battery energisers 12 V



LED control display

- **Impulse Control (cycle sequence monitoring):** Lights up when the energiser is in disrupted operation
- **System Control (argutector display):** Display at higher power consumption to maintain power
- **Voltage display:** 6-step LED display to check the fence voltage

Ergonomic carrying handle

- Carrying comfort thanks to soft grip padding
- Easy to move with one hand

Rotary potentiometer

- The output energy level (APN*) can be preselected on the rotary potentiometer (100 % - 50 %)

ON/OFF switch, menu pushbutton & Energy Control

- LED control display for the capacity and function of the 9 or 12 V batteries
- Shows the activity of the energiser
- Flashes in time with the pulse output

Extremely robust housing

- Particularly impact-resistant housing through use of high-quality plastics (PC and PP)
- Material is UV resistant, splash-proof and oil-resistant
- Housing holds 9 and 12 V batteries with a size up to 265 x 142 x 225 mm



6 modes functions

1. **NORMAL:** Normal pulse sequence
2. **SMART:** Normal pulse sequence APN*
3. **DAY MODE:** Normal pulse sequence APN* by day, slow pulse sequence at night
4. **NIGHT MODE:** Normal pulse sequence APN* at night, slow pulse sequence by day
5. **SLOW MODE:** Slow pulse sequence APN* by day and at night
6. **ONLY NIGHT MODE:** Normal pulse sequence APN* at night, no pulse sequence by day = additional energy savings, more efficiency, lower operating costs

Energy supply



Dual energiser with Safety*

Dual energisers can be connected in parallel to 230 V mains power and a 12 V battery. Uninterrupted operation is guaranteed in the event of a power failure! The energiser switches over automatically to battery operation.

Features

- 9 or 12 V batteries are integrated into the handy portable box where it is protected from the weather
- Contact with the rechargeable battery or the acid is avoided during transport
- Exhaustive discharge cut-off
- ECO Power / power saving function: the power economiser automatically adjusts power consumption to the status of the fence = less energy consumption, less environmental impact and lower costs
- Automatic switch-over to solar operation
- Solar charging control installed in the energiser is weather protected – easy charging of different types of rechargeable batteries
- Microprocessor control
- Tested and built according to the applicable EU directives and the safety standard EN60335-2-76 and DIN EN ISO 9001

Rear view



Earth terminal

Fence terminal

Advantage: 2 in 1



Housing can be secured by padlock



Device for attaching the appropriate solar panel to the back of the energiser cover



Safety advice: In 230 V operation, the energiser and the power supply unit should and must be installed in a room protected from moisture.

*APN = Output energy level is set to 50 % of the maximum energy and automatically adjusted in case of load changes, e.g. due to vegetation along the fence

DUAL

ranger® AN2000

ranger® AN3000

ranger® AN4800



Max. fence length:



Netting:	10 x 50 m
As per CEE:	50 km
Without vegetation:	20 km
Average vegetation:	4.5 km
High vegetation:	1.7 km

Netting:	12 x 50 m
As per CEE:	100 km
Without vegetation:	33 km
Average vegetation:	5 km
High vegetation:	2 km

Netting:	14 x 50 m
As per CEE:	130 km
Without vegetation:	60 km
Average vegetation:	20 km
High vegetation:	10 km

Animal husbandry:



Input:

• 2.7 J

Max. output:

• 2 J

Energy consumption:

• 65 - 215 mA

Max. voltage:

• 12,000 V

Voltage 500 Ω:

• 4,700 V

Dimensions (L x W x H):

• 24.0 x 31.5 x 38.0 cm

Scope of delivery:

• Energiser, fence connection cable

• 3.5 J

• 3 J

• 75 - 275 mA

• 12,000 V

• 5,200 V

• 24.0 x 31.5 x 38.0 cm

• Energiser, fence connection cable

• 5.7 J

• 4.8 J

• 85 - 450 mA

• 12,000 V

• 5,200 V

• 24.0 x 31.5 x 38.0 cm

• Energiser, fence connection cable

Art. No.	Unit	EAN
125H10854	1	4 014803 108548

Art. No.	Unit	EAN
125H10992	1	4 014803 109927

Art. No.	Unit	EAN
125H10993	1	4 014803 109934

Recommended accessories:

- 12 V AGM battery with 95 Ah (125H14600) ≥ service life: 17-78 days* or 12 V lead-fleece battery with 75 Ah (125H14479) ≥ service life: 15-69 days*
- 230 V power supply unit (125H47PSU0010FEU)
- Earth stake 2 x 1 m (125H140411)
- Solar panel 1 x 20 W (125H14538) or 1 x 30 W (125H14539)

- 12 V AGM battery with 95 Ah (125H14600) ≥ service life: 13-78 days* or 12 V lead-fleece battery with 75 Ah (125H14479) ≥ service life: 11-69 days*
- 230 V power supply unit (125H47PSU0010FEU)
- Earth stake 3 x 1 m (125H140411)
- Solar panel 1 x 20 W (125H14538) or 1 x 30 W (125H14539)

- 12 V AGM battery with 95 Ah (125H14600) ≥ service life: 8-37 days* or 12 V lead-fleece battery with 75 Ah (125H14479) ≥ service life: 7-33 days*
- 230 V power supply unit (125H47PSU0010FEU)
- Earth stake 5 x 1 m (125H140411)
- Solar panel 1 x 30 W (125H14539) or 1 x 50 W (125H14873)

Selected accessories

Find matching accessories for your horizont energiser in the comprehensive horizont range here in the catalogue or on the horizont website under the corresponding article number.



12 V AGM battery with 95 Ah (125H14600)

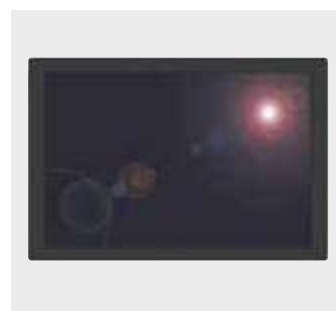

Solar panel 30 W (125H14539)

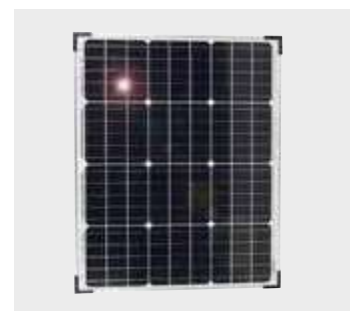

Solar panel 50 W (125H14873)

* The figures refer to a calculated use of 100 % of the stated capacity.

HORIZONT FENCE | Energisers | Battery energisers 12 V

turbomax®  Battery energisers 12 V



LED control display

- **Voltage display:** 6-step LED display to check the earthing and fence voltage
- **Alarm function:** Optical and acoustic alarm when the voltage drops below 400 ohms, the fence should be checked for faults or damage
- **2-stage CPN technology:** In the event of faults, higher energies are automatically fed into the fence (LED lights up red) after a safety margin of 55 seconds to ensure the safety of the herd
- **Power Control:** Shows the activity of the energiser and flashes in time with the pulse output
- **Energy Control:** LED control display for capacity and function of 9 or 12 V batteries
- **Impulse Control (cycle sequence monitoring):** Lights up when the energiser is in disrupted operation

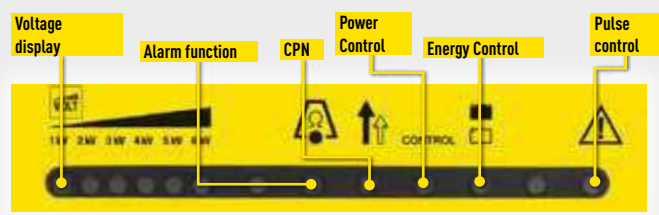

Energy supply



Dual energiser with Safety+

Dual energisers can be connected in parallel to 230 V mains power and a 12 V battery. Uninterrupted operation is guaranteed in the event of a power failure! The energiser switches over automatically to battery operation.

Safety advice

In 230 V operation, the energiser and the power supply unit should and must be installed in a room protected from moisture.

Features

- Hanging device for wall mounting
- ON/OFF switch integrated on the side
- Connection socket for the power supply unit on the underside
- Straightforward and visual information display – remote monitoring possible
- Exhaustive discharge cut-off
- turbomax technology: for fence loads > 500 ohms the energiser works with an enormously high energy potential to reliably supply the fence
- Automatic switch-over to solar operation
- Microprocessor control
- Tested and built according to the applicable EU directives and the safety standard EN60335-2-76 and DIN EN ISO 9001

* The figures refer to a calculated use of 100 % of the stated capacity.

DUAL

turbomax® AN800



Max. fence length:	Netting:	17 x 50 m
	As per CEE:	180 km
	Without vegetation:	55 km
	Average vegetation:	21 km
	High vegetation:	14 km

Animal husbandry:

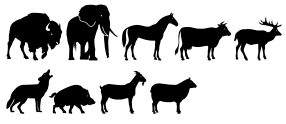

- Input:** - 12 J
- Max. output:** - 8 J
- Energy consumption:** - 500 - 1,200 mA
- Max. voltage:** - 12,000 V
- Voltage 500 Ω:** - 4,400 V
- Dimensions (L x W x H):** - 10.6 x 23.4 x 29.8 cm
- Scope of delivery:** - Energiser, mains plug, battery connecting cable

Art. No.	Unit	EAN
125H10749	1	4 014803 107497

Recommended accessories:

- 12 V battery special with 230 Ah (125H25012B) ≥ service life: 8-19 days*
- Earth stake 5 x 1.5 m (125H15017-1)
- Solar panel 1 x 50 W (125H14873)
- Large-capacity battery box (125H21264)
- Warning sign international (125H14127)
- Earth cable

Selected accessories

Find matching accessories for your horizon energiser in the comprehensive horizon range here in the catalogue or on the horizon website under the corresponding article number.



12 V battery special with 230 Ah (125H25012B) and solar panel 50 W (125H14873)



Mains energisers 230 V

The use of a mains energiser assumes that you can access a mains connection in the immediate vicinity of the pasture area.

A mains energiser has the following advantages over other types of power supply:

- High efficiency
- Continuous & reliable operation on 230 V mains
- High operating comfort - no battery replacement necessary
- Can also be used with denser vegetation and animals that are difficult to herd
- Reasonable consumption

trapper® Mains energiser 230 V



Power Control

- Shows the activity of the energiser
- Flashes in time with the pulse output



Handy housing

- Particularly impact-resistant housing through use of high-quality ABS plastics (PC and PP)
- Material is UV resistant, splash-proof and oil-resistant

Energy supply



Features

- Very sturdy housing
- Power Control (pulse control)
- Tested and built according to the applicable EU directives and the safety standard EN60335-2-76 and DIN EN ISO 9001



Hanging device for wall mounting

trapper® N45



Max. fence length:	Netting:	3 x 50 m
	As per CEE:	15 km
	Without vegetation:	4 km
	Average vegetation:	2 km
	High vegetation:	0.8 km

Animal husbandry:



Input:	• 0.8 J
Max. output:	• 0.45 J
Energy consumption:	• 1.5 W
Max. voltage:	• 8,000 V
Voltage 500 Ω:	• 3,900 V
Dimensions (L x W x H):	• 5.8 x 12.4 x 17.2 cm
Scope of delivery:	• Energiser, mains plug, dowels, screws

Art. No.	Unit	EAN
125H10864	1	4 014803 108647

Recommended accessories:

- Earth stake 1 x 1 m (125H140411)
- Fence connection kit (125H15522)
- Fence tester farmer (125H14527)

Selected accessories

Find matching accessories for your horizon energiser in the comprehensive horizon range here in the catalogue or on the horizon website under the corresponding article number.

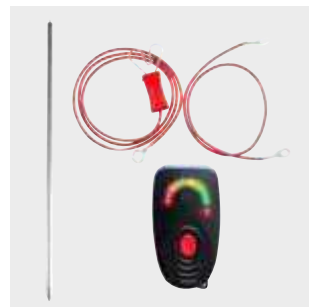

Earth stake (125H140411), fence connection kit (125H15522C), fence tester farmer (125H14527C)

farmer® Mains energiser 230 V



Extremely robust housing

- Particularly impact-resistant housing through use of high-quality plastics (PC)
- Material is UV resistant, splash-proof and oil-resistant



Earth terminal

Fence terminal

Power Control

- Shows the activity of the energiser
- Flashes in time with the pulse output

Energy supply



230V AC

Features

- Very sturdy housing
- Power Control (pulse control)
- Tested and built according to the applicable EU directives and the safety standard EN60335-2-76 and DIN EN ISO 9001



Hanging device for wall mounting



Ventilation slots to allow discharge of condensation water

Safety advice: In 230 V operation, the energiser and the power supply unit should and must be installed in a room protected from moisture.

farmer® N200



Max. fence length:	Netting:	10 x 50 m
	As per CEE:	50 km
	Without vegetation:	15 km
	Average vegetation:	4 km
	High vegetation:	1.4 km

Animal husbandry:



- Input:** - 2.8 J
- Max. output:** - 2 J *
- Energy consumption:** - 5 W
- Max. voltage:** - 14,000 V
- Voltage 500 Ω:** - 5,200 V
- Dimensions (L x W x H):** - 9.9 x 22.8 x 28.4 cm
- Scope of delivery:** - Energiser, mains plug, dowels and screws

Art. No.	Unit	EAN
125H10996	1	4 014803 109965

Recommended accessories:

- Earth stake 2 x 1 m (125H140411)
- Fence connection kit (125H15522)
- Fence tester farmer (125H14527)
- Warning sign international (125H14127)
- Lightning protection choke (125H15482)
- Earth cable

Selected accessories

Find matching accessories for your horizont energiser in the comprehensive horizont range here in the catalogue or on the horizont website under the corresponding article number.

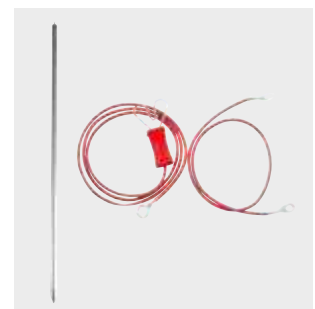

Earth stake 1 m (125H140411), fence connection kit (125H15522), fence tester farmer (125H14527)

hotshock® Mains energiser 230 V

Extremely robust housing

- Particularly impact-resistant housing through use of high-quality plastics (PC)
- Material is UV resistant, splash-proof and oil-resistant



Impulse Control (cycle sequence monitoring)

- Lights up when the energiser drops below the power limit- disrupted operation

Average fence terminal

- For paddocks and small pastures (output < 1 J)

Earth terminal

Powerful fence terminal

- For large pastures

Power Control

- Shows the activity of the energiser
- Flashes in time with the pulse output

Energy supply



230V[~]

Features

- Two fence terminals for operating one large and one small pasture or paddock
- Tested and built according to the applicable EU directives and the safety standard EN60335-2-76 and DIN EN ISO 9001



Hanging device for wall mounting



Ventilation slots to allow discharge of condensation water

Safety advice: In 230 V operation, the energiser and the power supply unit should and must be installed in a room protected from moisture.

* at 110 % test voltage 253 V

hotshock® N500



Max. fence length:	Netting:	16 x 50 m
	As per CEE:	120 km
	Without vegetation:	45 km
	Average vegetation:	20 km
	High vegetation:	10 km

Animal husbandry:



Input:

• 6 J

Max. output:

• 5 J *

Energy consumption:

• 8 W

Max. voltage:

• 9,500 V

Voltage 500 Ω:

• 6,000 V

Dimensions (L x W x H):

• 9.9 x 22.8 x 28.4 cm

Scope of delivery:

• Energiser, mains plug, dowels and screws

Art. No. Unit EAN

125H10614

1

4 014803 106148

Recommended accessories:

- Earth stake 3 x 1.5 m (125H15017-1)
- Fence connection kit (125H15522)
- Lightning protection choke (125H15482)

Selected accessories

Find matching accessories for your horizon energiser in the comprehensive horizon range here in the catalogue or on the horizon website under the corresponding article number.



Earth stake 1.5 m (125H15017-1), fence connection kit (125H15522), lightning protection choke (125H15482)

ranger®  **Mains energiser 230 V**



Extremely robust housing

- Particularly impact-resistant housing through use of high-quality plastics (PC)
- Material is UV resistant, splash-proof and oil-resistant

Impulse Control (cycle sequence monitoring)

- Lights up when the energiser drops below the power limit – disrupted operation



Control display

- **Voltage display:** 6-step display to check the fence voltage
- **Earthing control:** Display for checking the earthing

Average fence terminal

- For paddocks and small pastures (output < 1 J)

Powerful fence terminal

- For large pastures

Earth terminal

Energy supply



230V \approx

Dual energisers

Advantage: 2 in 1! Dual energisers can be connected in parallel to 230 V mains power and a 12 V battery. Uninterrupted operation is guaranteed in the event of a power failure.

Features

- Two fence terminals for operating one large and one small pasture or paddock
- Straightforward and visual information display – easy remote monitoring possible
- Tested and built according to the applicable EU directives and the safety standard EN60335-2-76 and DIN EN ISO 9001

Voltage display

Earthing control

Pulse control



Hanging device for wall mounting



Ventilation slots to allow discharge of condensation water

Safety advice: In 230 V operation, the energiser and the power supply unit should and must be installed in a room protected from moisture.

Mains energisers 230 V

ranger® N270



ranger® N420



Max. fence length:

Netting:	12 x 50 m
As per CEE:	60 km
Without vegetation:	20 km
Average vegetation:	5 km
High vegetation:	2 km

Netting:	16 x 50 m
As per CEE:	100 km
Without vegetation:	40 km
Average vegetation:	10 km
High vegetation:	4 km

Animal husbandry:



- Input:**
- Max. output:**
- Energy consumption:**
- Max. voltage:**
- Voltage 500 Ω:**
- Dimensions (L x W x H):**
- Scope of delivery:**

- 3.4 J
- 2.7 J
- 5 W
- 13,500 V
- 5,400 V
- 9.9 x 22.8 x 28.4 cm
- Energiser, mains plug, dowels and screws

- 6 J
- 4.2 J
- 7 W
- 9,300 V
- 5,600 V
- 9.9 x 22.8 x 28.4 cm
- Energiser, mains plug, dowels and screws

Art. No.	Unit	EAN
125H10608	1	4 014803 106087

Art. No.	Unit	EAN
125H10742	1	4 014803 107428

Recommended accessories:

- Earth stake 2 x 1.5 m (125H15017-1)
- Lightning protection choke (125H15482)
- Fence connection kit (125H15522)
- Warning sign international (125H14127)
- Earth cable

- Earth stake 3 x 1.5 m (125H15017-1)
- Lightning protection choke (125H15482)
- Fence connection kit (125H15522)
- Warning sign international (125H14127)
- Earth cable

Selected accessories

Find matching accessories for your horizon energiser in the comprehensive horizon range here in the catalogue or on the horizon website under the corresponding article number.

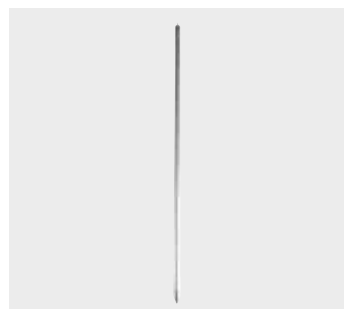

Earth stake 1.5 m (125H15017-1)



Lightning protection choke (125H15482)



Fence connection kit (125H15522)

turbomax[®] Mains energiser 230 V

Extremely robust housing

- Particularly impact-resistant housing through use of high-quality plastics (PC)
- Material is UV resistant, splash-proof and oil-resistant



Side view

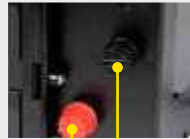

Fence terminal

Earth terminal

LED control display

- **Voltage display:** 6-step LED display to check the earthing and fence voltage
- **Alarm function:** Optical and acoustic alarm when the voltage drops below 400 ohms, the fence should be checked for faults or damage
- **2-stage CPN technology:** In the event of faults, higher energies are automatically fed into the fence (LED lights up red) after a safety margin of 55 seconds to ensure herding security

turbomax[®] N1430



Max. fence length:	Netting:	30 x 50 m
	As per CEE:	320 km
	Without vegetation:	85 km
	Average vegetation:	40 km
	High vegetation:	25 km

Animal husbandry:

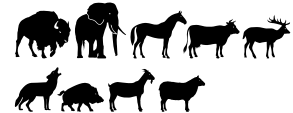

- Input:** - 25 J
- Max. output:** - 14.3 J
- Energy consumption:** - 35 W
- Max. voltage:** - 12,000 V
- Voltage 500 Ω:** - 4,600 V
- Dimensions (L x W x H):** - 10.6 x 23.4 x 29.8 cm
- Scope of delivery:** - Energiser, mains plug

Art. No.	Unit	EAN
125H10748	1	4 014803 107480



Features

- Straightforward and visual information display – remote monitoring possible
- turbomax technology: for fence loads > 500 ohms the energiser works with an enormously high energy potential to reliably supply the fence
- Microprocessor control
- Tested and built according to the applicable EU directives and the safety standard EN60335-2-76 and DIN EN ISO 9001



Hanging device for wall mounting

Accessories:

- Earth stake 9 x 1.5 m (125H15017-1)
- Large-capacity battery box (125H21264)
- Fence tester turbomax (125H14151)
- Lightning protection choke (125H15482)
- Warning sign international (125H14127)
- Earth cable

accessories

Find matching accessories for your horizon energiser in the comprehensive horizon range here in the catalogue or on the horizon website under the corresponding article number.



Fence tester turbomax (125H14151), lightning protection choke (125H15482)



Solar energisers

The following horizon solar energisers have an integrated solar panel. This supports the 12 V battery in that it does not need to be recharged so often, as it is discharged more economically.

The solar support is a worthwhile investment in the long term, especially during the sunny times of the year.

The advantage of the solar energisers is that they are delivered fully assembled. The energiser is therefore immediately operational after the rechargeable battery has been fully charged. The components are matched to each other so that the energisers on the fence provide super performance.

trapper® Solar energisers



Ergonomic carrying handle

- Easy to move with one hand



Extremely robust housing

- Particularly impact-resistant housing through use of high-quality plastics (ABS)
- Material is UV resistant, splash-proof and oil-resistant

TIP

Charge the battery before starting up!

Robust plastic solar panel

- Environmentally friendly use of solar energy
- Compact unit of energiser and solar panel

ON/OFF switch & Energy Control

- 3-stage LED control display for capacity and function of 9 or 12 V batteries
- Shows the activity of the energiser
- Flashes in time with the pulse output

Rear view



Earth terminal

Fence terminal

Energy supply



Features

- Very sturdy housing
- Power Control (pulse control)
- Automatic switch-over to solar operation
- Solar charging control installed weather-protected in housing
- Microprocessor control



230 V charging socket to keep the integrated 12 V battery charged



Twist lock on the back to open the housing



Plug-in profile for earthing rod in housing



Inclined front for easy alignment of solar panel to the sun

trapper® AS25



Max. fence length:

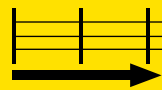

As per CEE:	8.5 km
Without vegetation:	5 km
Average vegetation:	3 km
High vegetation:	0.9 km

Animal husbandry:



Input:

- 0.33 J

Max. output:

- 0.25 J

Energy consumption:

- 26 mA

Max. voltage:

- 9,000 V

Voltage 500 Ω:

- 3,000 V

Dimensions (L x W x H):

- 23.1 x 37.4 x 32.0 cm

Scope of delivery:

- Energiser, power supply unit, earth stake (approx. 30 cm), 12 V battery, 5 W solar panel, fence and earth connecting cable

Art. No. Unit EAN

125H14982

1



Recommended accessories:

- Earth stake 1 x 1 m (125H140411)
- Fence tester farmer (125H14527)
- Warning sign international (125H14127)

Selected accessories

Find matching accessories for your horizontal energiser in the comprehensive horizontal range here in the catalogue or on the horizontal website under the corresponding article number.

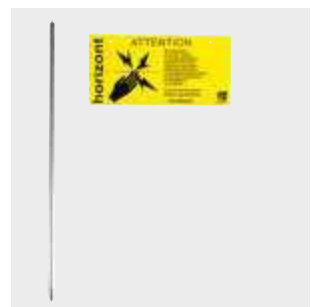

Earth stake (125H140411), warning sign, international (125H14127)

farmer® Solar energisers



Ergonomic carrying handle

- Easy to move with one hand



Extremely robust housing

- Particularly impact-resistant housing through use of high-quality plastics (ABS)
- Material is UV resistant, splash-proof and oil-resistant

TIP

Charge the battery before starting up!

Robust plastic solar panel

- Environmentally friendly use of solar energy
- Compact unit of energiser and solar panel

ON/OFF switch & Energy Control

- 3-stage LED control display for capacity and function of 9 or 12 V batteries
- Shows the activity of the energiser
- Flashes in time with the pulse output

Rear view



Earth terminal

Fence terminal

Energy supply



Features

- ECO Power / power saving function: The power economiser automatically adjusts power consumption to the status of the fence = less energy consumption, less environmental impact and lower costs
- Automatic switch-over to solar operation
- Solar charging control installed in the energiser is weather protected – easy charging of different types of rechargeable batteries
- Microprocessor control



230 V charging socket to keep the integrated 12 V battery charged



Twist lock on the back to open the housing



Plug-in profile for earthing rod in housing



Inclined front for easy alignment of solar panel to the sun

farmer® AS50



Max. fence length:

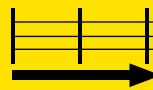

As per CEE:	8.5 km
Without vegetation:	5 km
Average vegetation:	3 km
High vegetation:	0.9 km

Animal husbandry:



Input:

• 0.65 J

Max. output:

• 0.5 J

Energy consumption:

• 20 - 50 mA

Max. voltage:

• 11,000 V

Voltage 500 Ω:

• 3,600 V

Dimensions (L x W x H):

• 23.1 x 37.4 x 32.0 cm

Scope of delivery:

- Energiser, power supply unit, 12 V rechargeable battery, 10 W solar panel, fence and earth connecting cable

Art. No. Unit EAN

125H14485

1



Recommended accessories:

- Earth stake 1 x 1 m (125H140411)
- Fence tester farmer (125H14527)
- Warning sign international (125H14127)

Selected accessories

Find matching accessories for your horizon energiser in the comprehensive horizon catalogue or on the horizon website under the corresponding article number.



Earth stake (125H140411), warning sign international (125H14127)

farmer® Solar energisers



Ergonomic carrying handle

- Easy to move with one hand



Extremely robust housing

- Particularly impact-resistant housing through use of high-quality plastics (ABS)
- Material is UV resistant, splash-proof and oil-resistant

TIP

Charge the battery before starting up!

Robust plastic solar panel

- Environmentally friendly use of solar energy
- Compact unit of energiser and solar panel

ON/OFF switch & Energy Control

- 3-stage LED control display for capacity and function of 9 or 12 V batteries
- Shows the activity of the energiser
- Flashes in time with the pulse output

Rear view



Earth terminal

Fence terminal

Energy supply



Features

- ECO Power / power saving function: the power economiser automatically adjusts power consumption to the status of the fence = less energy consumption, less environmental impact and lower costs
- Automatic switch-over to solar operation
- Solar charging control installed in the energiser is weather protected – easy charging of different types of rechargeable batteries
- Microprocessor control



230 V charging socket to keep the integrated 12 V battery charged



Twist lock on the back to open the housing



Plug-in profile for earthing rod in housing



Inclined front for easy alignment of solar panel to the sun

NEW farmer® AS140



Max. fence length:

- As per CEE: 48 km
- Without vegetation: 14 km
- Average vegetation: 5 km
- High vegetation: 1.5 km

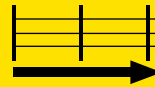

Animal husbandry:



Input:

- 2.0 J

Max. output:

- 1.4 J

Energy consumption:

- 30 - 200 mA

Max. voltage:

- 10,000 V

Voltage 500 Ω:

- 4,600 V

Scope of delivery:

- Energiser, power supply unit, earth stake (approx. 30 cm), 12 V battery, 24 W solar panel, fence and earth connecting cable

Art. No.	Unit	EAN
125H14478	1	4 014803 144782

Recommended accessories:

- Earth stake 2 x 1 m (125H140411)
- Fence tester farmer (125H14527)
- Warning sign international (125H14127)

Selected accessories

Find matching accessories for your horizont energiser in the comprehensive horizont range here in the catalogue or on the horizont website under the corresponding article number.

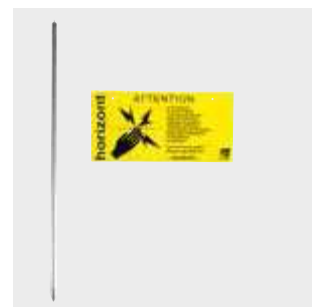

Earth stake (125H140411), fence tester farmer (125H14527), warning sign international (125H14127)

THINGS TO KNOW ABOUT

EARTHING & CONTROL

1. WHY IS EARTHING AT THE FENCE SO IMPORTANT?

The most important prerequisite to ensure optimum herding security as well as full energiser performance at the fence is proper earthing. The fence system is a circuit in which electricity flows.

CAUTION: It is not necessary to set up the fence in a circle to close the circuit because it is closed when touched by the animal. The current thus flows from the energiser through the conductors, the animal body (or vegetation) over the ground, through the earth stakes back to the energiser. Insufficient earthing means that less current flows and the deterrent effect on the animal is reduced. The danger: The animal escapes or enters the fenced area.

Closing the electric circuit with correct earthing

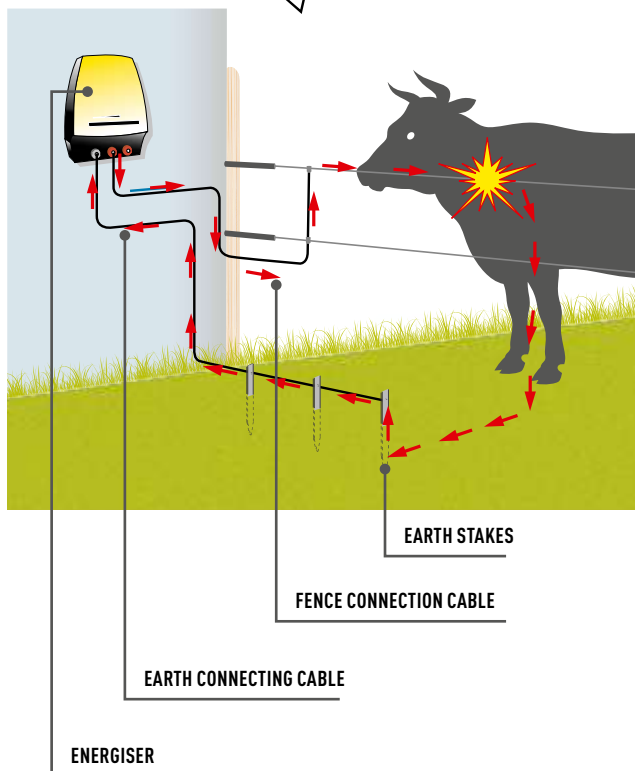

TIP: FAULT DETECTION

Connect long supply lines from the energiser to the fence in a branching box every 50-100 m. This can be easily opened and the cables checked for function by measuring the voltage. Troubleshooting is significantly simplified, especially for cables laid in the ground.

2. WHAT IS IMPORTANT TO PAY ATTENTION TO IN TERMS OF SOIL CONDITIONS?

Soil can have a very high resistance and significantly affect the herding security of the electric fence system. The goal is to minimise soil resistance, and this is achieved by good soil conductivity. Damp soil with good turf favours conductivity, while dry soil with little grass cover makes good earthing difficult. Difficult weather conditions, such as a layer of snow and frost, can also severely affect the earthing. If the ground is sandy, we recommend using an open or uninsulated earth conductor and earthing it at regular intervals. The more poorly the soil conducts, the more earth stakes should be used.

3. HOW DOES ONE EARTH AN ELECTRIC FENCE PROPERLY?

One or several earth stakes are inserted at least 1 m deep into the soil until they reach damp earth. When using several earth stakes, space them 3 m apart. The earth stakes are then connected to the energiser using high voltage cables and connecting cables. The number and depth of the earth stakes is crucial: The more and the deeper, the better.

CAUTION: Only use galvanised, rust-free materials for earthing, as a layer of rust will greatly impair the effect.

EARTHING CHECKLIST

- ✓ Energiser
- ✓ Earth stake
- ✓ Earth connecting cable & connection cable
- ✓ Fence tester

4. WHEN AND HOW IS EARTHING CHECKED?

Earthing reliability should be checked when the pasture is put to use in the spring and during the dry period in the summer. Also in the event of faults in the fence as well as after installation of a new energiser.

Certain measuring instruments or fence testers are used for this purpose.

The test procedure is as follows: You produce a short circuit by placing iron posts against the electrical conductor about 100 m away from the energiser. Ensure good contact with the conductor and drive the post at least 30 cm into the soil. The fence voltage should now drop to 2000 V (1000 V for dry soil).

The earthing rod of the voltmeter is inserted into the soil about 1 m from the last earth rod of the energiser, and the measuring contact is held to the last earthing rod of the energiser. The value should be under 1000 V. Note: The smaller the value, the better. You should always check your fence system daily and look after your animals. Written documentation helps to prove that you checked.

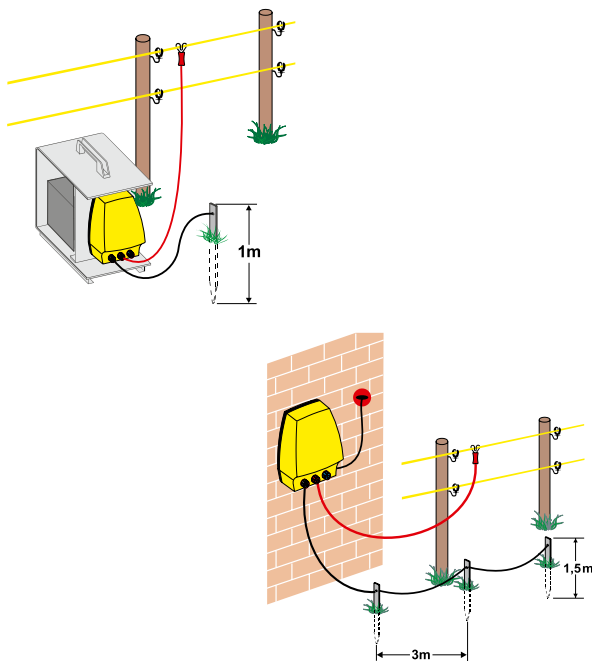

5. WHICH SAFETY REGULATIONS MUST BE OBSERVED?

When earthing the energiser, a minimum distance of 10 m to other earthing systems (e.g. building earthing) must be maintained to prevent the voltage from flashing over (e.g. in the event of a lightning strike). This safety distance is important to avoid endangering the house earthing including water and power lines. The distance between the earthing of the energiser and the lightning protection should also be at least 10 m.

Excessive voltage (like a lightning strike) can destroy the energiser, the fence is no longer functional and the animal can escape. To prevent this, a lightning protection system should be installed between the energiser and the fence system. This is a requirement inside the building. It is considered a recommendation for installation outside buildings. It is particularly useful when using a mains energiser, as the current can flash over to the mains.

A so-called lightning protection choke effectively protects the energiser against damage caused by lightning and excessive voltages.

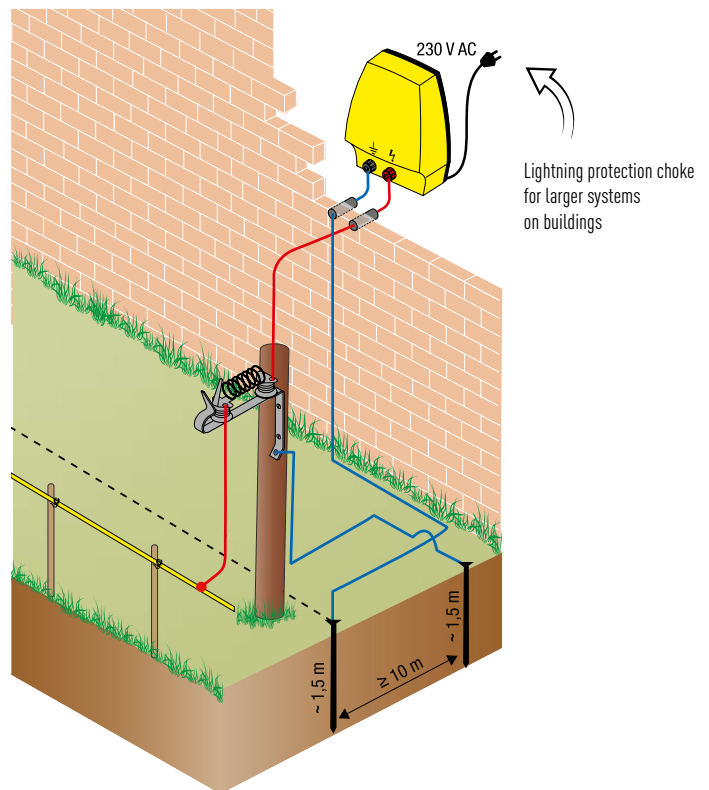

Important icons for this chapter:

Product describing icons:

These icons describe earthing & control features.



Height



Width



Diameter



Material thickness



Stainless steel



Galvanized

HORIZONT FENCE | Earthing & control | Earth stakes



T-earth stake

- Suitable for:** • 12 V Battery and mains energisers
Length: • 100 cm
Material: • Angle section, galvanized
Material thickness: • 3 mm
Scope of delivery: • Complete with connection bolt

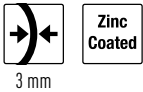

Art. No.	Unit	EAN
125H140411	1	4 014803 434265

Earth cable and warning



15516

Earth / Connecting / Supply cable

- Application:** • Overhead and buried fence supply cables, connection of earthing rods and for power supply at gates
Advantage: • Double insulated
 • Conductor of galvanized steel wire
 • Electric strength is at < 20,000 V

Art. No.	Reel	Diameter	max. supply cable length	Resistance	Unit	EAN
125H14040	25 m	1.6 mm	500 m	0.07 Ω/m	1	4 014803 140401
125H15525	50 m	1.6 mm	500 m	0.07 Ω/m	1	4 014803 155252
125H15956	100 m	1.6 mm	500 m	0.07 Ω/m	1	4 014803 159564
125H15516	100 m	2.5 mm	1,000 m	0.035 Ω/m	1	4 014803 155160

TIP



To protect the earth cable, it is advisable to lay it in a protective hose or pipe.



Warning sign international

- Dimensions:** • 20 x 10 cm
Scope of delivery: • Warning sign printed on both sides

Art. No.	Unit	EAN
125H14127	4	4 014803 141279

Fence connection kit

- Suitable for:**
- Heart clamp for connection to tape up to 12 mm, rope, polywire and wire
- Advantage:**
- High voltage cable of the heart clamp with reinforced plastic sheath to avoid voltage flashovers
- Material:**
- Galvanized
- Scope of delivery:**
- Connecting cable 120 cm, earth cable 50 cm

Art. No.	Unit	EAN
9HOR15522	1	4 014803 405784



Zinc Coated

Energiser and earth connection kit

- Suitable for:**
- Heart clamp for connection to tape up to 12 mm, rope, polywire and wire
- Advantage:**
- Earth connecting cable for fastening to earthing rod
- Material:**
- Galvanized
- Scope of delivery:**
- Earthing rod, fence connection cable 2 m, earth connecting cable 3 m, Warning sign

Art. No.	Unit	EAN
125H15858C	1	4 014803 158581



Zinc Coated

Fence tester

NEW Fence tester trapper®

- Advantage:**
- 6 recessed glow lamps for easy reading of voltage
 - Non-slip insulation of the earth stake - additional safety in operation
 - When not in use, the cable can be wrapped around the fence tester and the earthing rod can be fixed in place - easy handling and additional protection against damage
- Operation:**
- Operation without battery!
- Scope of delivery:**
- Fence tester

Art. No.	Unit	EAN
125H14494	1	4 014803 144942



HORIZONT FENCE | Earthing & control | Fence tester



Fence tester ranger®

- Advantage:**
- Digital display for accurate reading of the voltage
 - Device switches on automatically when fence voltage is applied
 - Non-slip insulation of the earth stake enables safe operation
 - Cable can be wrapped around the fence tester when not in use – easy handling and additional protection against damage
- Operation:**
- Battery operation
- Scope of delivery:**
- Fence tester, battery

Art. No.	Unit	EAN
125H14496	1	3 700393 916595



Fence tester turbomax® Fence scout

- Advantage:**
- Measuring device for fence voltage, amperage and as fault finder
 - Measuring range up to 10,000 V
 - Display of current flow direction
 - Direction display of the fault
 - Display lighting
 - Acoustic signals
 - With battery control indicator
- Operation:**
- Battery operation
- Scope of delivery:**
- Fence tester, 9 V block battery, belt pouch

Art. No.	Unit	EAN
125H14151	Limited stock	3 700393 916540

Lightning protection and fence switch

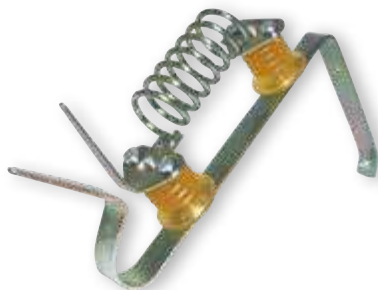

Lightning protection choke

- Suitable for:**
- Electric fence installation on building installations
- Advantage:**
- Effectively protects energiser from damage caused by lightning and excessive voltage

Art. No.	Unit	EAN
125H15482	1	4 014803 154828

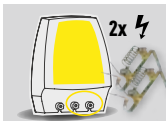

DOUBLE LIGHTNING PROTECTION

Energisers with two fence terminals also require two lightning protection systems.

Safety advice: To prevent lightning damage, an earthed lightning spark gap must be installed in the fence supply cable to the building, or prior to entry into a building. The lightning protection device must be installed by a specialist if the energiser is installed inside the building. The wiring must be carried out by a specialist according to the installation instructions. Do not combine lightning protection earth and operational earth of the electric fence system.

THINGS TO KNOW ABOUT NETTING



The horizon service for you:
Two year warranty on the
UV stability of all netting.

PREMIUM QUALITY
MADE IN GERMANY

All horizon netting are produced in
Germany, which is why they are known for
their **premium quality**.

1. THE FUNCTION OF NETTING

Netting consists of horizontal and vertical polywires. These polywires are made of monofilament plastic threads and the current-carrying polywires are additionally made of wires. A quality feature here is the number and thickness of the wires. With regard to plastic monofilaments, resistance to sunlight and mechanical strength also play a special role. horizon plastic monofilaments are therefore made of high-quality polyethylene (PE for short) with an additive for UV stabilization. Special reinforcements of the vertical polywires, the plastic struts, can further increase the stability of the netting (for specific applications under increased weather conditions, such as wind and snow loads, as well as in uneven terrain).

Various posts with different heights and thickness are also available to ensure optimal vertical fixing of the netting. There are various types of netting, depending on the application, which differ in the spacing between the polywires and the number and arrangement of the current-carrying polywires.

2. THE APPLICATION

As a livestock owner you can keep your animals in or out with a electric fence or an electric net. Animals that have a dense coat or plumage, such as poultry, sheep and goats, are ideally guarded with an electric net. Due to their size, small animals such as cats, dogs or rabbits can also be managed with netting. The same rule can also be applied when warding off wildlife or wolves. In this case, the horizon range offers optimal netting and polywire fencing solutions.

The different types of netting are classified according to the different animal species into sheep/goat, poultry and small animal nets (rabbits, cats).

THE CONDUCTIVITY

The required herding pulse energy can be achieved through high electrical conductivity (of the polywires or wires). Each horizon netting type contains information on conductivity, e.g. the symbol A++, which stands for the highest conductivity.



When using netting on particularly dry soil, it is advisable to use netting with earth conductors. If the netting is touched by the animal in this case, the dry soil prevents the necessary transport of electrical pulse energy back to the earth connection of the energiser. The earth conductor of the corresponding netting can act as a substitute and feed the pulse back to the energiser. Netting with earthing conductors can be used in all soil conditions. Particular strengths of the netting are in dry soils and earthing problems.

THE VEGETATION SITUATION

TIP

There should be no vegetation under the netting; vegetation should be removed before installation. Depending on the netting, the bottom current-carrying conductor is 5, 10 or 20 cm from the ground. This important conductor is therefore so close to the ground or vegetation as no other electric fence.

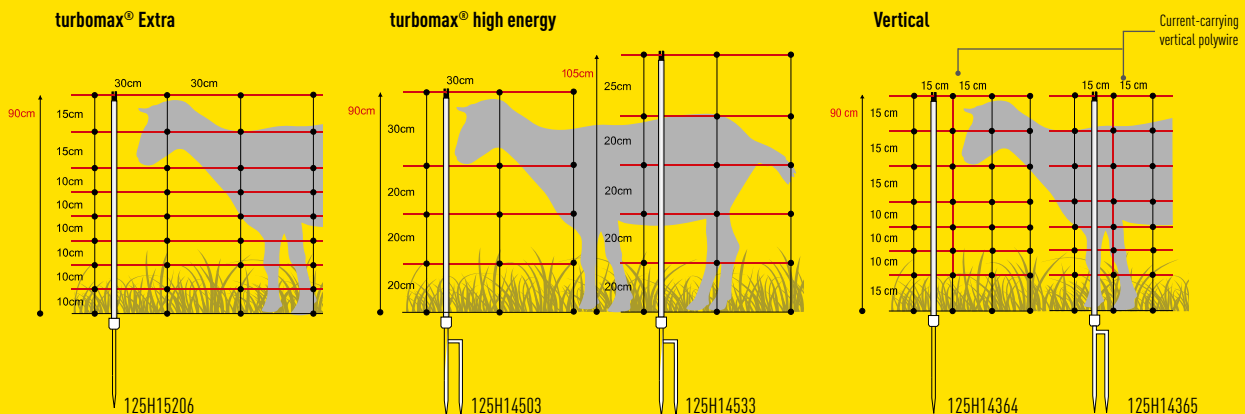



3. CHOOSING THE CORRECT POSTS

The posts can be selected according to soil conditions and preferences (single or double prong).



SINGLE PRONG

- Use on stony ground or in the mountains

DOUBLE PRONG

- Use on loose or firm stone-free ground
- The post can be anchored in the ground without tools thanks to the tread
- A double prong achieves a greater stability

The horizont posts are particularly stable. The post material is specifically optimised for multiple tensile loads that occur when pulling out net posts. The high strength and adapted elasticity, as well as the special connection technology of the post with the earth spikes, ensure a particularly long durability compared to conventional posts in mobile use.

The polywire insulator at ground level, which is located on the post-earth spike, ensures close contact with the spike. It therefore supports the conductivity of a net with an electrical earth wire. Using additional posts to press down the bottom wire strand in uneven soil conditions helps avoid an electrical connection of the live polywires. This also eliminates possible gaps which wild animals can use to slip through, for example.

4. CONNECTION TO AN ENERGISER

horizont offers special energisers for the herding of animals with an insulating coat of wool, hair or feathers. Since the netting is often set up well inside the vegetation, horizont energisers are designed for exactly such conditions.

5. THE ASSEMBLY AND DISMANTLING OF NETTING

CUTTING THE PASTURE AREA FREE

Why is it so important for the netting to have the pasture area cut free?

The trimmed corridor under the set up netting prevents the first current-carrying polywire from being overgrown through vegetation. The vegetation cannot conduct energy away from the netting into the ground. If the first current-carrying polywires are free from vegetation, no energy will be lost from the fence.

POSTS

How do I choose the optimal post?

The broader surface of posts with double prong makes it easier to drive them into the ground. Yet the double prong is difficult to drive into stony ground. It is better to use a single prong here.

CORNER WITH POST

How does a corner solution work for the sheep net fence with additional posts?

The additional post for the sheep net is necessary if there is no built-in post available in the corner. A "standard" plastic post can be used there, for example.

CONNECTING SHEEP NETTING

How is a net overlap created in sheep netting?

This is attached at points where the nets meet. This means the netting is properly stretched in parallel at this point in the resulting length. It is important that the designated cable ends of the netting is connected conductively.

CONNECTING SHEEP NETTING CONDUCTIVELY TOGETHER

How is the netting conductively connected at the two starting points?

Both of the cable ends of the netting are properly staked around the posts to eliminate unnecessary protrusion. Both clips of the ends are then connected without tools to establish a clean electrical contact on the fence.

SECURING SHEEP

How to deal with gaps between the netting and the ground due to ground depressions?

Lambs or even sheep could slip under the fence here. It is therefore important to check the sheep net fence! The netting can be stretched on the ground with the supplied stakes. This guarantees better herding security.

CONNECTING THE ENERGISER

The energiser should be connected to the connecting clips of the netting. This enables the best contact performance.

ROLLING UP SHEEP NETTING

The netting is picked up at the posts. The actual netting (wire strand) is then rolled up to the posts. The netting is tied together with the strings.

Horinetz
Sheep and goat netting

- Suitable for:**
- Sheep and goats
 - Wolf deterrent and repelling of wild boars
- Bottom mesh size:**
- 15.0 cm high and 15.5 cm wide
- Advantages:**
- Good conductivity and extremely durable
 - High load rating possible
- Scope of delivery:**
- 1 x herding net horinetz complete
 - 14 plastic posts with single or double prong
 - 1 x repair kit, 1 x warning sign and 2 x ground stakes
- Accessories:**
- Replacement post with double prong Ø 13 mm, 90 cm high (125H15022-2), 105 cm high (125H15026-2) or 120 cm high (125H14384-2)

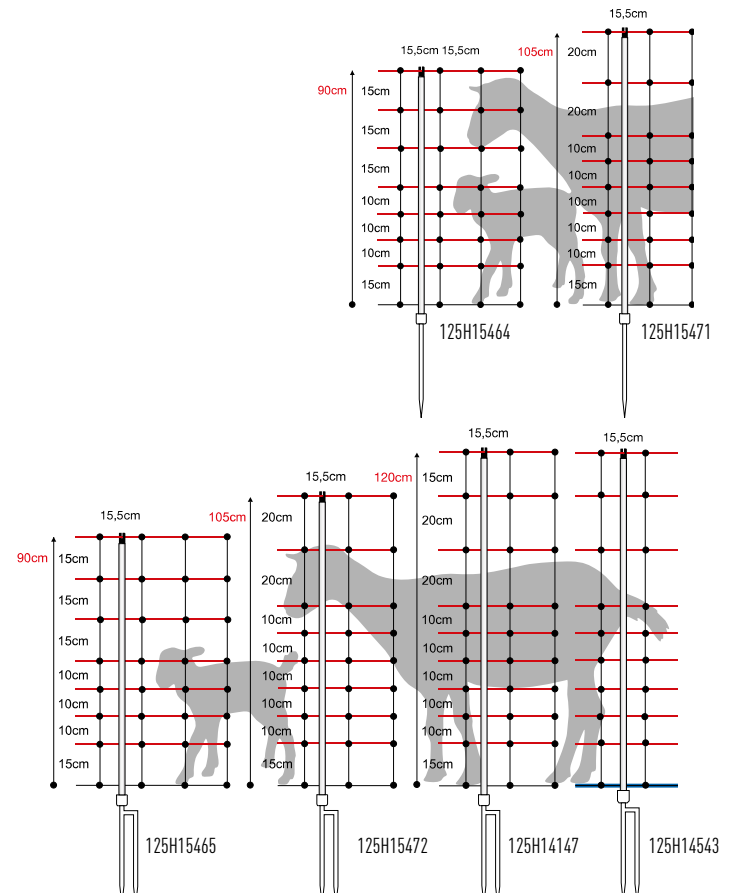

Art. No.	Netting height	Netting length	Prong	Number of posts/ material	Colour of posts	Colour of netting	Horizontal polywires	Current-carrying polywires	Resistance	Unit	EAN
125H15464	90 cm	50 m	Single prong	14 / plastic	white	●●	8	7	1.15 Ω / m	1	4 014803 154644
125H15465	90 cm	50 m	Double prong	14 / plastic	white	●●	8	7	1.15 Ω / m	1	4 014803 154651
125H15471	105 cm	50 m	Single prong	14 / plastic	white	●●	9	8	1.01 Ω / m	1	4 014803 154712
125H15472	105 cm	50 m	Double prong	14 / plastic	white	●●	9	8	1.01 Ω / m	1	4 014803 154729
125H14147	120 cm	50 m	Double prong	14 / plastic	white	●●	10	9	0.84 Ω / m	1	4 014803 141477



HORIZONTAL FENCE | Netting | Sheep and goat netting

Turbomax® Extra Sheep and goat netting



- Suitable for:**
- Sheep and goats
 - Wolf deterrent and wild boar repellent
- Bottom mesh size:**
- 10 cm high and 30 cm wide
- Advantages:**
- High stability through special vertical connections
 - Tight mesh spacing prevents lambs from breaking out
 - Professional netting with high conductivity – for more safety
 - White with black outside edges for more contrast to the surroundings and for better visibility
 - horizontal quality with high-quality copper conductor
- Scope of delivery:**
- 1 x herding net complete, 50 m long
 - 14 x plastic posts with single or double prong
 - 1 x repair kit, 1 x warning sign and 2 x ground stakes
- Accessories:**
- Replacement post with double prong Ø 13 mm, 90 cm high (125H15022-2) or 105 cm high (125H15026-2)

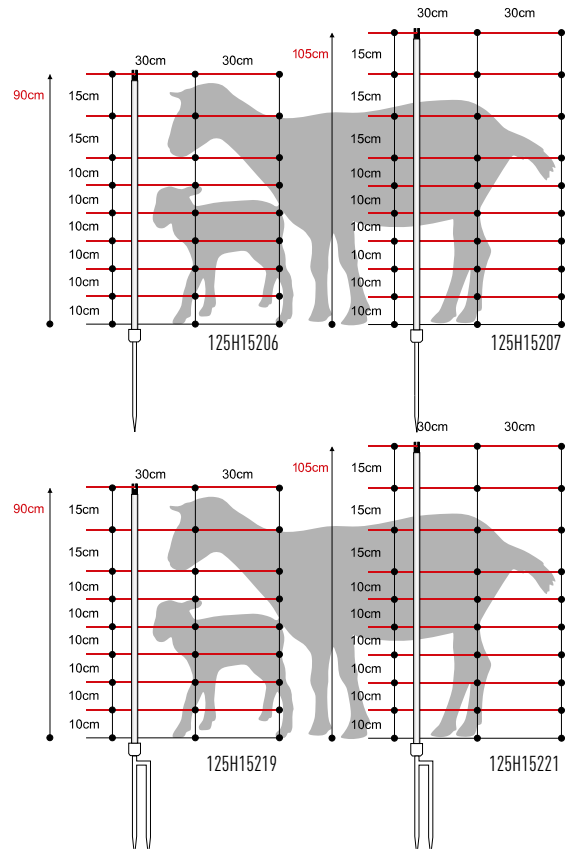

Art. No.	Netting height	Netting length	Prong	Number of posts/ material	Colour of posts	Colour of netting	Horizontal polywires	Current-carrying polywires	Resistance	Unit	EAN
125H15206	90 cm	50 m	Single prong	14 / plastic	white	○●	9	8	0.29 Ω / m	1	4 0 14803 152060
125H15207	105 cm	50 m	Single prong	14 / plastic	white	○●	10	9	0.28 Ω / m	1	4 0 14803 152077
125H15221	105 cm	50 m	Double prong	14 / plastic	white	○●	10	9	0.28 Ω / m	1	4 0 14803 152213



Turbomax® Plus
Sheep and goat netting

- Suitable for:**
- Sheep and goats
 - Wolf deterrent and wild boar repellent
- Bottom mesh size:**
- 10 cm high and 30 cm wide
- Advantages:**
- Both bottom polywires are not current-carrying - no discharge and so cutting free is not necessary
 - High stability through rigid verticals
 - Long operating life due to robust conductor material
 - White polywire with black outside edges for more contrast to the surroundings and for better visibility
- Scope of delivery:**
- horicont quality with high-quality copper conductor
 - 1 x herding net turbomax high energy complete, 90 cm high, 50 m long
 - 14 x plastic posts with single prongs
 - 1 x repair kit, 1 x warning sign and 2 x ground stakes
 - Connecting accessories
- Accessories:**
- Replacement post with single prong Ø 13 mm, 90 cm high (125H14664)

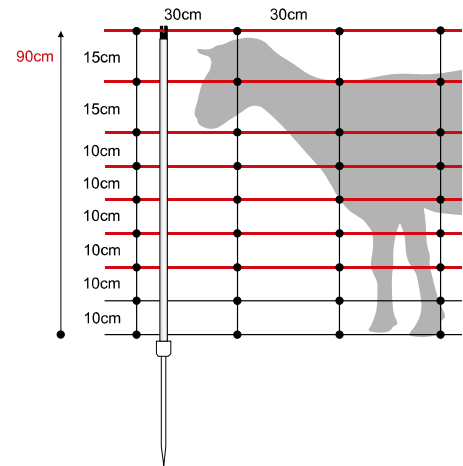

Art. No.	Netting height	Netting length	Prong	Number of posts and material	Colour of posts	Colour of netting	Horizontal polywires	Current-carrying polywires	Resistance	Unit	EAN
125H14955	90 cm	50 m	Single prong	14 plastic posts	white		9	7	0.33 Ω / m	1	4 014803 149558



hotshock®
The hotshock® energisers are perfectly suited for use on herding nets!

RECOMMENDED BY SHEEP BREEDING ASSOCIATIONS

WOLF DETERRENT

FROM HORIZONT



THE CURRENT SITUATION AND OUR SOLUTIONS FOR YOU

Wolves have been detected in nearly all parts of Germany. The wolf has returned to wide parts of Germany. The delight over what we consider to be an extinct animal is clouded by the fact that it considers farm animals to be part of its diet. This is backed up by the sufferings endured by sheep and goat farmers across the country. This is where the electric fence comes into play, the development of which has been part of horizont's profession for decades. In several research projects in cooperation with the Saxon Sheep and Goat Breeding Association and the Baden-Württemberg State Sheep Breeding Association, horizont has developed reliable and particularly effective wolf deterrent systems to protect your farm animals. The netting has been extensively tested in practice and is recommended by the associations – for more safety on your pastures!

TURBOMAX HIGH ENERGY

The turbomax high energy netting is suitable for uneven terrain and mountains. Since the lower mesh spacings are particularly large, small wild animals can also slip through the netting and remain unharmed. Rigid verticals in the netting ensure solid stability. High energy in the netting is ensured due to a reduced number of horizontal polywires. The reduced number of horizontal polywires guarantees a particularly high conductivity with low energy consumption of the energiser.

HORINETZ SUPER PLUS

With the horinetz super with a height of 90 cm, a 20 mm wide tape can also be inserted at a height of 120 cm. The special construction can prevent the wolf from jumping over the net, as the movement of the tape in the wind irritates the wolf's field of vision and it cannot calculate its jump over the netting. UV-stable plastic posts in combination with double prongs ensure a secure stability, even in loose soil or in windy conditions.

HORINETZ SUPER

The horinetz super is an extra high special net as wolf deterrent with 145 cm height. In combination with further wolf deterrent measures, this high netting offers very good protection against the wolf and prevents attacks on your animals. The stable posts with a 19 mm post diameter ensure the secure stability of the netting. This ensures that your animals are safely and reliably fenced in.



Art. No. 125H14503/ 125H14533
with additional earth conductor: Art. No. 125H14534/ 125H14652



Art. No. 125H14992/ 125H14925



Art. No. 125H14967

Horinetz super
Wolf deterrent netting



- Suitable for:**
- Sheep and goats
 - Wolf deterrent and wild boar repellent
- Bottom mesh size:**
- 15 cm high and 15 cm wide
- Advantages:**
- Extra high special net for wolf defence with 145 cm height
 - High stability due to reinforced top and bottom polywires
- Scope of delivery:**
- 1 x herding net wolf deterrent netting horinetz super complete, 145 cm high, 50 m long
 - 15 x plastic posts with double prongs
 - 1 x repair kit, 1 x warning sign and 2 x ground stakes
- Accessories:**
- Replacement post with double prong Ø 19 mm, 145 cm high (125H14993)

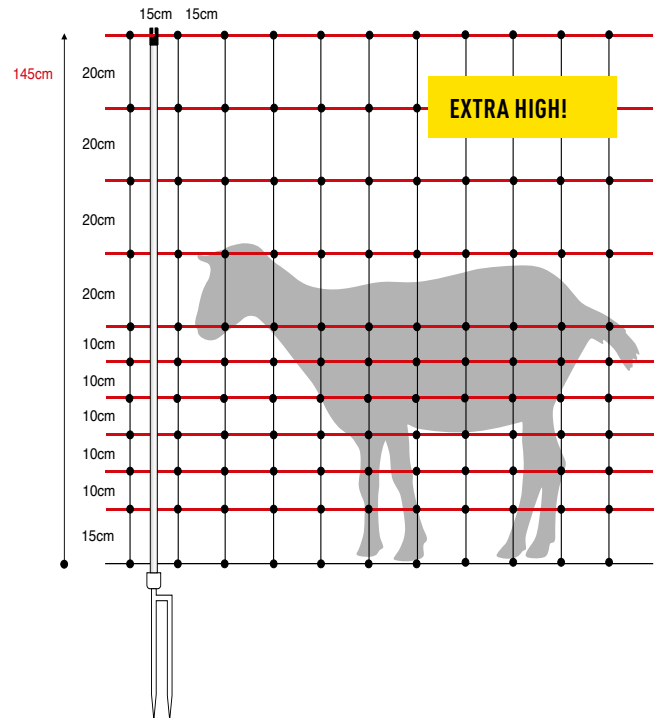

Art. No.	Netting height	Netting length	Prong	Number of posts/ material	Colour of posts	Colour of netting	Horizontal polywires	Current-carrying polywires	Resistance	Unit	EAN
125H14967	145 cm	50 m	Double prong	15 / plastic	black	●●	11	10	0.81 Ω / m	1	4 014803 149671



HORIZONT FENCE | Netting | Wolf deterrent netting

Horinetz super plus Wolf deterrent netting

- Suitable for:**
- Sheep and goats
 - Wolf deterrent and wild boar repellent
- Bottom mesh size:**
- 15 cm high and 15.5 cm wide
- Advantages:**
- Recommended by the Saxon Sheep and Goat Breeding Association
 - Increased jump height through additional 20 mm tape at 120 cm height
 - Quick and easy assembly
- Scope of delivery:**
- High energy due to accompanying earth conductor
 - 1 x herding net wolf deterrent netting horinetz super plus complete, 50 m long
 - 15 x plastic posts with single or double prong
 - 1 x additional post 1.20 m for adaptation to ground contour
- Accessories:**
- 1 x repair kit, 1 x warning sign and 2 x ground stakes
 - Replacement post with double prong Ø 13 mm, 90 cm high (125H15022-2, 15)
 - 20 mm tape (125H17111)
 - Earth stake for guying and earthing (125H15017-1)
 - Tape connecting cable (125H10447)



A wolf deterrent system was developed together with the Saxon Sheep and Goat Breeding Association which is unique to date and has proven to prevent wolves from attacking farm animals.

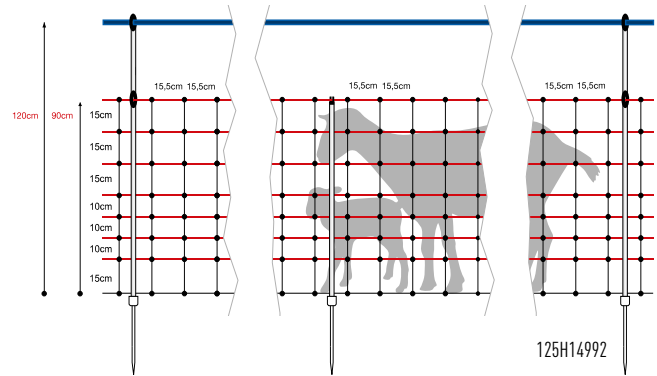

Art. No.	Netting height	Netting Length	Prong	Number of posts/ material	Colour of posts	Colour of netting	Horizontal polywires	Current-carrying polywires	Resistance	Unit	EAN
125H14925	90 / 120 cm	50 m	Double prong	15 / plastic	white	Yellow/Black	8	7	1.15 Ω / m	1	4 0 14803 149251

Anti-jump protection through additional tape

- Netting increased to 120 cm through 20 mm tape
- The movement of the tape irritates the wolf; it cannot calculate the jump

Posts with double prongs

- Posts are made of UV-resistant plastic
- Double prongs ensure secure stability even in loose soil or in windy conditions

High stability

- Top and ground polywires reinforced by more than 60 %

High energy due to accompanying earth conductor

Good visibility

- Yellow polywires are easier to see in twilight or darkness

Turbomax® high energy
Wolf deterrent netting

- Suitable for:**
- Sheep and goats
 - Wolf deterrent and wild boar repellent
- Bottom mesh size:**
- 20 cm high and 30 cm wide
- Advantages:**
- Due to large mesh spacing at the bottom, small wild animals can slip through and are thus protected
 - Rigid verticals ensure solid stability
 - Low weight – 10% lighter than conventional netting
 - Reduced number of horizontal polywires provides high energy due to less contact with vegetation
 - White with black outside edges for more contrast to the surroundings and for better visibility
- Scope of delivery:**
- 1 x herding net turbomax high energy complete, 50 m long
 - 14 x plastic posts with double prongs
 - 1 x repair kit, 1 x warning sign and 2 x ground stakes
- Accessories:**
- Replacement post with double prong Ø 13 mm, 90 cm high (125H15022-2) or 105 cm high (125H15026-2)



The particularly high herding security is recommended by the Baden-Württemberg State Sheep Breeding Association. This sheep and goat netting was developed together with horizont.

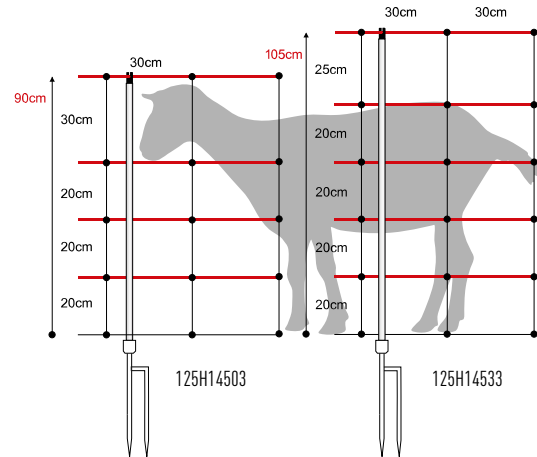

Connecting clip



Head insulator



Ground stake

Art. No.	Netting height	Netting length	Prong	Number of posts/ material	Colour of posts	Colour of netting	Horizontal polywires	Current-carrying polywires	Resistance	Unit	EAN
125H14503	90 cm	50 m	Double prong	14 / plastic	white	○●	5	4	0.33 Ω / m	1	4 014803 145031



HORIZONT FENCE | Netting | Poultry netting

Ranger® Poultry netting 105 cm



- Suitable for:**
- Chickens, turkeys, geese and ducks
- Bottom mesh size:**
- 5 cm high and 7.5 cm wide
- Advantages:**
- High conductivity for optimal herding security
 - High quality posts for high stability
 - Materials are rust-free and therefore extremely resistant
- Scope of delivery:**
- 1 x poultry netting complete, 105 cm high, 50 m long
 - 15 x posts with single or double prongs
 - 1 x repair kit, 1 x warning sign and 2 x ground stakes
- Accessories:**
- Replacement post with double prong Ø 13 mm, 105 cm high (125H15026-2)

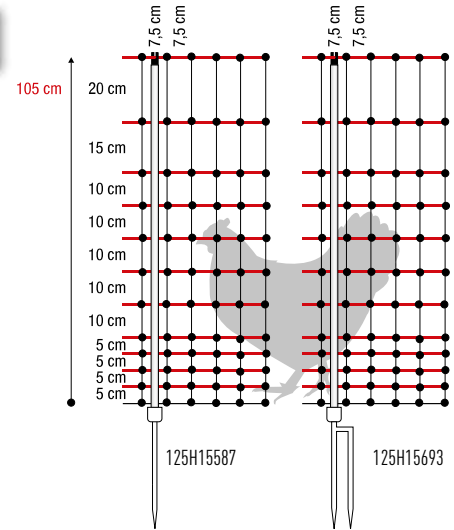

Art. No.	Netting height	Netting length	Prong	Number of posts/ material	Colour of posts	Colour of netting	Horizontal polywires	Current-carrying polywires	Resistance	Unit	EAN
125H15587	105 cm	50 m	Single prong	15 / plastic	white	●●	12	11	0.74 Ω / m	1	4 014803 155870

Ranger® security Poultry netting (not electrifiable)



- Suitable for:**
- Chickens, turkeys, geese and ducks
- Bottom mesh size:**
- 5 cm high and 7.5 cm wide
- Advantages:**
- Tool-free connection of several nets
 - High quality posts for high stability
 - Without current-carrying conductors, no electrification possible
- Scope of delivery:**
- 1 x poultry netting complete, 105 cm high, 50 m long
 - Posts with single or double prongs
 - Repair kit, 2 x ground stakes
- Accessories:**
- Replacement post with double prong Ø 13 mm, 110 cm high (125H14662)

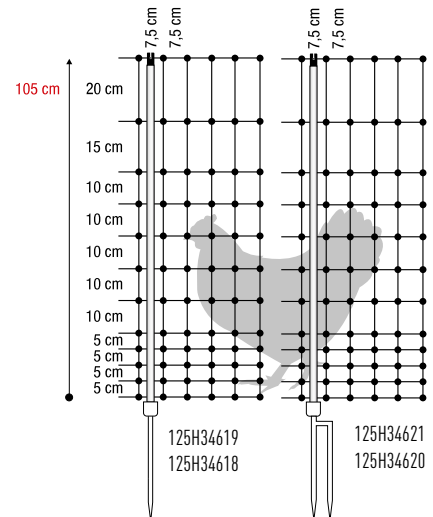

Art. No.	Netting height	Netting length	Prong	Number of posts/ material	Colour of posts	Colour of netting	Horizontal polywires	Current-carrying polywires	Resistance	Unit	EAN
125H34619	105 cm	25 m	Single prong	9 / plastic	green	●	12	not electrifiable		1	4 014803 346193
125H34618	105 cm	50 m	Single prong	15 / plastic	green	●	12	not electrifiable		1	4 014803 346186



EVEN MORE FOR FEATHERED FRIENDS



Our animal husbandry catalogue offers the right range of products for poultry farming. Let our service team assist you.

Farmer® extra | small animal netting

- Suitable for:** • Chicks, small hares and rabbits
- Bottom mesh size:** • 5 cm high and 7.5 cm wide
- Advantages:** • High quality posts for high stability
• horizon quality with high-quality stainless steel conductors
- Scope of delivery:** • 1 x herding net complete, 50 cm high, 50 m long
• 15 x posts with single prongs
• Connecting accessories
- Accessories:** • Replacement post with single prong with Ø 13 mm, 50 cm high (125H15028)

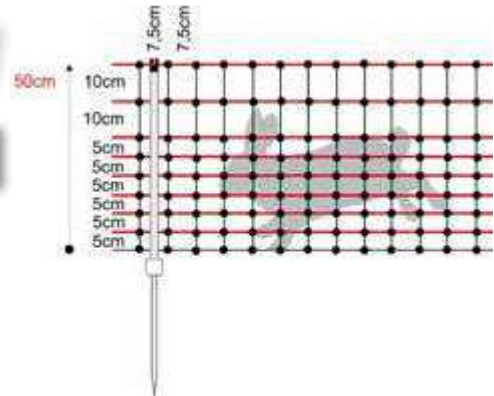

Art. No.	Netting height	Netting length	Prong	Number of posts/ material	Colour of posts	Colour of netting	Horizontal polywires	Current-carrying polywires	Resistance	Unit	EAN
125H15576	50 cm	50 m	Single prong	15 / plastic	white	●●	9	8	1.01 Ω / m	1	4 014803 155764

Farmer® plus | small animal netting

- Suitable for:** • Chicks, small hares and rabbits
- Bottom mesh size:** • 6 cm high and 6 cm wide
- Advantages:** • High quality posts for high stability
• horizon quality with high-quality stainless steel conductors
- Scope of delivery:** • 1 x herding net complete, 65 cm high, 50 m long
• 15 x posts with single prongs
• Connecting accessories
- Accessories:** • Replacement post with single prong with Ø 13 mm, 50 cm high (125H15223)

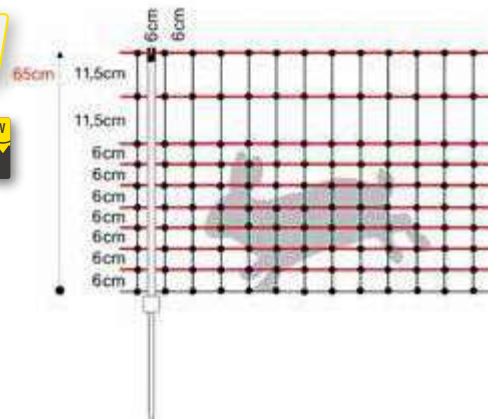

Art. No.	Netting height	Netting length	Prong	Number of posts/ material	Colour of posts	Colour of netting	Horizontal polywires	Current-carrying polywires	Resistance	Unit	EAN
125H14895	65 cm	50 m	Single prong	15 / plastic	green	●	10	9	0.90 Ω / m	1	4 014803 148957

THINGS TO KNOW ABOUT

CONDUCTOR MATERIAL

& ACCESSORIES

Conductor materials must be highly conductive, tear-resistant and weatherproof. Good visibility can increase the effect and is essential for fleeing animals like horses. Due to the risk of injury, barbed wire should not be used as a fence conductor. Apart from the energiser, conductor material is one of the most important components of the fence system for mobile or permanent fencing. By choosing the right conductor, you can significantly influence herding security.

1. THE RIGHT CHOICE OF CONDUCTOR MATERIAL

Conductor materials can be plastic-metal mixtures or pure metallic materials - e.g. various electrifiable wires, these have the highest conductivity. Particular attention should be paid to the following values when selecting the conductor material:

Ω/m The **RESISTANCE** is given in ohms / m. The lower this value, the higher the quality of the conductor material. High resistance values cannot be compensated even with powerful energisers!

The **BREAKING LOAD** is given in kilograms and indicates the maximum load (in kg) or tensile force the conductor material can withstand.



The **NUMBER AND THICKNESS** of the current-carrying conductors provides information about its conductivity. The more conductors and the thicker the conductors are in the conductor material, the more current is carried.



IN GENERAL: The better the electricity is transported in the fence, the longer fences can be built or the higher the herding voltage in the fence.

SEVERAL LEVELS IN THE FENCE:

When using several levels in the fence, the following should be noted:

- The total resistance of the fence system decreases with each additional level (conductor material) – but it is always smaller than the lowest resistance value of a level
- With fencing, the same conductor material should always be used on the different levels, as this guarantees optimum herding security – different conductor materials can also be mixed in the fence system under special conditions (e.g. in cattle farming)
- If the lowest level of the conductor material is covered with vegetation, the energy loss from the fence increases due to current leakage
- Ideally, the levels in the fence are free of vegetation, which has a positive effect on the maximum fence length
- For outdoor fencing, the use of conductor material with low resistance values is recommended – however, subdivisions in the fence or strip grazing can also be equipped with conductor material with higher Ω/m values due to their small size

RECOMMENDATIONS FOR DIFFERENT TYPES OF ANIMALS:

For different types of animals, horizon recommends different conductor materials and a certain number of levels when building fences:

HORSES

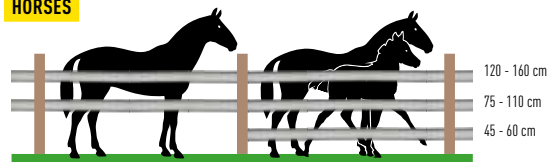

horizon recommends fencing horses with 40 mm wide electric fence tape; horses are fleeing animals, and the wider the electric fence tape, the better it is perceived by the animals. This considerably reduces the risk of injury and escape of your animals!

CATTLE

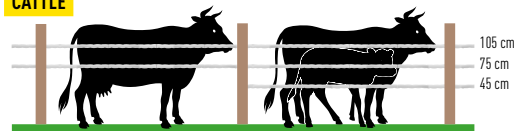

horizon recommends fencing cattle with electric fence rope or polywire.

SHEEP AND GOATS



Sheep and goats can be fenced in locally with electric fence polywire. Alternatively, electric nets are also ideal for herding such animals.

POULTRY

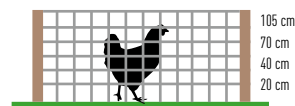

horizon recommends fencing in poultry with electric nets.

WILDLIFE OR WOLF DETERRENT

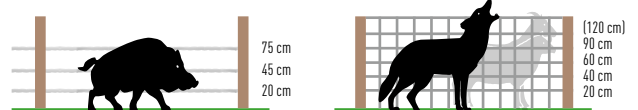

horizon recommends securing corn fields or forest areas against wild boars with electric fence tape or rope. For wolf deterrent and for the protection of sheep or goats, horizon recommends the use of special wolf deterrent netting.

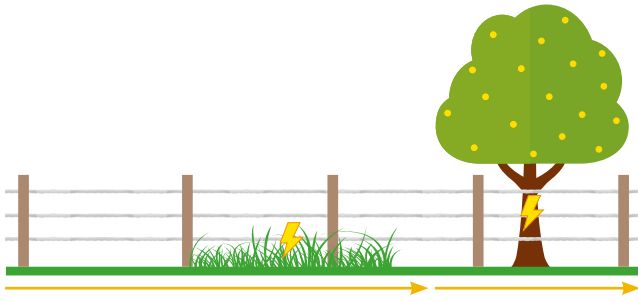

2. MALFUNCTIONS AT THE FENCE

The above diagram illustrates the malfunctions that can be caused by vegetation at the fence, for example. Consequently, the fence should always be kept in proper condition, the fence voltage should be checked regularly, the fence should be kept free of vegetation and connectors should be used if a conductor breaks. This will increase the durability of your fence and the safety of your animals will not be reduced by avoidable defects in the fence. The fence gains stability.

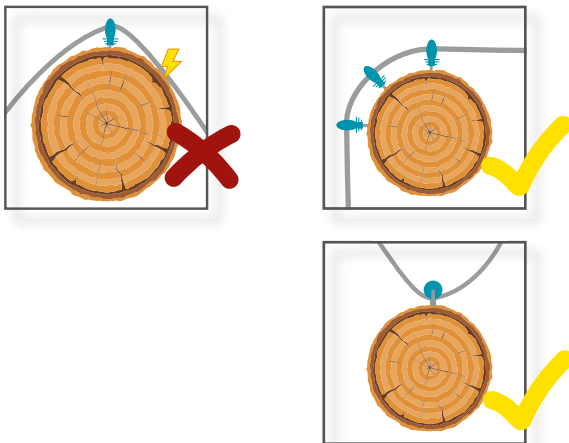

Conductor material attached to wood posts, often resulting from incorrectly attached insulators, can also influence the current flow. The conductor material should always be run in appropriate insulators.

3. TIPS FOR HANDLING CONDUCTOR MATERIAL

If the conductor material is torn, use suitable accessories such as connectors to restore the herding security. If the conductor material is sagging and needs to be re-tensioned, use the appropriate tensioners to keep it properly at height again. Do not wrap the conductor material in the dry room of the insulators; this can cause spark-overs on the support of the insulator. In winter, water accumulation can cause the conductor material to be significantly heavier and sag. If you do not use your pasture in winter, dismantle your fence. A recommended method for easy and practical storage of the conductor material is to wind it onto reels. This allows for direct storage and the use of reels also makes it easier to reassemble the fence in the spring.

Do not knot the conductor material, as a constant current flow in the fence is no longer guaranteed in this case. Instead, use suitable connectors from horizont.

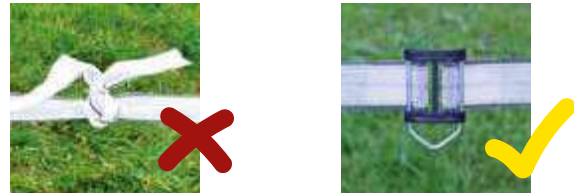

In areas particularly exposed to the wind, electric fence tapes should be twisted when tensioned, as this reduces the surface area exposed to gusts of wind and increases the stability of your fence.

4. DIFFERENT LEVELS OF QUALITY

Various technologies were developed for the horizont conductor material to make it even more conductive. The different resistance values are decisive here:

TLDmax TECHNOLOGY	turbomax®	0,08 - 0,17 Ω / m
TLDmax TECHNOLOGY	ranger®	0,20 - 0,53 Ω / m
TLDmax TECHNOLOGY	hotshock®	0,24 - 0,53 Ω / m

THE CONDUCTIVITY:

The required herding pulse energy can be achieved through high electrical conductivity. Each horizont conductor material type contains information on conductivity, e.g. the symbol A++, which stands for the highest conductivity.

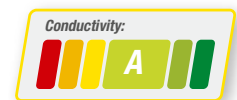

Important icons for this chapter:

Product describing icons:

These icons describe insulator features.



Polypropylene



Galvanized



Aluminium



Length

Cross selling icons:

These icons refer to products that are additionally required and are compatible with the selected product.



Tape



Rope



Polywire



Wire



Gate handle



TIP:
Your fence system should have stable corner and intermediate posts which simultaneously tension the electric fence tape and keep it at height. This keeps it straight and parallel to each other.

ELECTRIC FENCE TAPES

horizont electric fence tapes are available in different series, which are characterized by the maximum fence length. horizont offers the appropriate electric fence tape for every individual application. When choosing the conductor material, pay attention to width and colour for optimum herding security.

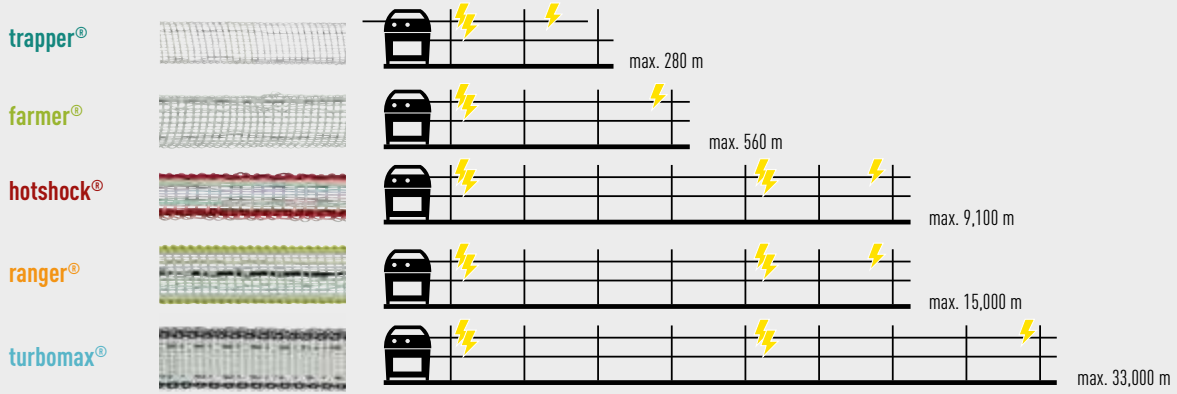

Maximum fence lengths: The length specifications show the maximum possible fence length of a level without vegetation with an appropriately strong energiser.

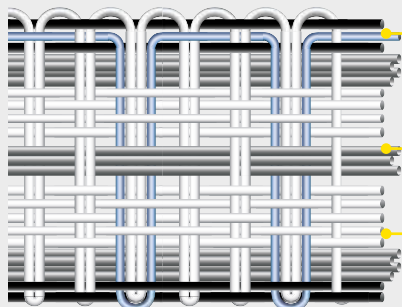

turbomax® electric fence tapes

Cross-connections ensure the consistent flow of current and optimum current conduction.

Bundled **TLDmax** - conductors ensure highest conductivity and high current flow.

Polyethylene threads ensure maximum durability and high breaking loads.

*Fence length: Specification for simple fences with one conductor and without vegetation. Depending on the amount of vegetation, this will reduce the specified fence lengths. If using several fence conductors on several levels, longer fences are possible.

Electric fence tape trapper®

- Suitable for:**
- Short fences and strip grazing
- Advantage:**
- Monofilaments with high UV stability
 - Stainless steel conductor for good conductivity and highest bending strength
- Colour:**
- White: for more contrast to the surroundings and increased visibility in twilight and darkness



Art. No.	Designation	Width	Reel	Max. fence length*	Breaking load	Number of conductors	Ø Stainless steel conductor	Resistance	Colour	Unit	EAN
125H17280	trapper® T10 - W	10 mm	250 m	210 m	~ 20 kg	3	0,15 mm	14,40 Ω/m	○	1	4 014803 459718

Electric fence tape farmer®

- Suitable for:**
- Short fences and strip grazing
- Advantage:**
- High breaking loads
 - Monofilaments with high UV stability
 - Stainless steel conductor for good conductivity and highest bending strength
- Colour:**
- White: for more contrast to the surroundings and increased visibility in twilight and darkness
 - Yellow/orange: good visibility
 - Green: blends in well with nature



Art. No.	Designation	Width	Reel	Max. fence length*	Breaking load	Number of conductors	Ø Stainless steel conductor	Resistance	Colour	Unit	EAN
125H17451	farmer® T10 - W	10 mm	200 m	210 m	~ 40 kg	3	0,15 mm	14,40 Ω/m	○	1	4 014803 174512
125H17287	farmer® T10 - O	10 mm	200 m	210 m	~ 40 kg	3	0,15 mm	14,40 Ω/m	●●	1	4 014803 172877
125H17475	farmer® T20 - W	20 mm	200 m	280 m	~ 90 kg	4	0,15 mm	10,80 Ω/m	○	1	4 014803 174758
125H17272	farmer® T20 - W	20 mm	2 x 200 m	280 m	~ 90 kg	4	0,15 mm	10,80 Ω/m	○	1	4 014803 172723
125H17528	farmer® T20 - O	20 mm	200 m	280 m	~ 90 kg	4	0,15 mm	10,80 Ω/m	●●	1	4 014803 175281
125H17458	farmer® T40 - W	40 mm	200 m	560 m	~ 120 kg	8	0,15 mm	5,40 Ω/m	○	1	4 014803 174581
125H17458008	farmer® T40 - G	40 mm	200 m	560 m	~ 120 kg	8	0,15 mm	5,40 Ω/m	●	1	4 014803 428813

Electric fence tape turbomax®

- Suitable for:**
- Long to very long fences
- Advantage:**
- High conductivity ensures high herding security
 - Conductors of **TLDmax** are extremely weather-resistant
 - Cross-connections guarantee a continuous current flow and ensure optimum current conduction even in the event of conductor breakage
 - Polyethylene threads ensure maximum durability and high breaking loads
- Colour:**
- White: with black outer edges: for more contrast to the surroundings and increased visibility in twilight and darkness



Art. No.	Designation	Width	Reel	Max. fence length*	Breaking load	Number of conductors	TLDmax	Ø Stainless steel conductor	Resistance	Colour	Unit	EAN
125H17110	turbomax® T12	12 mm	200 m	21,400 m	~ 60 kg	6	5 x 0,30 mm	1 x 0,20 mm	0,14 Ω/m	○●	1	4 014803 171108
125H17111	turbomax® T20	20 mm	200 m	20,000 m	~ 140 kg	8	7 x 0,25 mm	1 x 0,20 mm	0,15 Ω/m	○●	1	4 014803 171115
125H17112	turbomax® T40	40 mm	200 m	33,300 m	~ 240 kg	12	11 x 0,25 mm	1 x 0,20 mm	0,09 Ω/m	○●	1	4 014803 171122

HORIZONT FENCE | Conductor material | Electric fence tape



Electric fence tape hotshock®

- Suitable for:**
- Medium fence lengths
- Advantage:**
- Greater durability due to additional corrosion protection
 - Reinforced conductor material with higher breaking load
 - Specifically for strong energisers (wildlife deterrent)
- Colour:**
- White/blue: good visibility for animal and human

Art. No.	Designation	Width	Reel	Max. fence length*	Breaking load	Number of conductors	TBmax	Resistance	Colour	Unit	EAN
125H17211	hotshock® T12	12 mm	200 m	8,600 m	~ 100 kg	6	0,30 mm	0.36 Ω/m		1	4 014803 467423

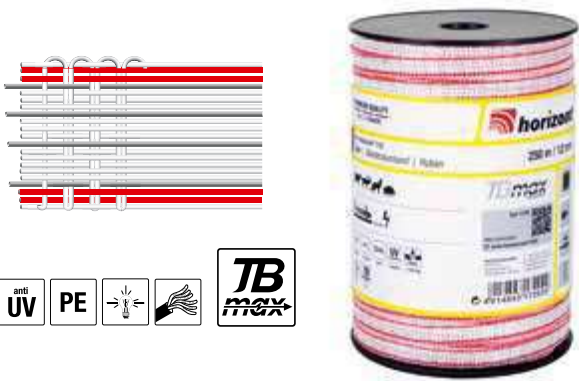

Electric fence tape hotshock®

For all HOTSHOCK T12 tapes, the TBmax conductors ensure high conductivity. These HOTSHOCK energisers are specially designed to withstand high power, ideal for keeping sheep and fighting game and wild animals.

The wires are made of polyethylene, which gives them increased protection against UV rays, allowing them to last longer and have a high breaking strength.

Art. No.	Designation	Width	Number of conductors	TBmax	Resistance	max.	Max. fence length*	EAN
125H17202	hotshock® T12	250 m	4	0,30 mm	0,533 Ω/m	~ 100 kg	5 600 m	4 014803 172020



Electric fence tape ranger®

- Suitable for:**
- Medium to long fences
- Advantage:**
- High conductivity
 - Polyethylene monofilaments for high tensile strength
 - Bundled TLDmax - conductors for highest current flow
 - High tensile loads can be absorbed due to particularly high and reinforced outside edges (only for 125H17121, 125H17122, 125H17124, 125H17125)
- Colour:**
- White with yellow outside edges: For more contrast to the surroundings and increased visibility in twilight and darkness
 - Yellow/blue/green: fluorescent effect, especially good visibility against darker backgrounds like forests
 - Green: blends in well with nature
 - Brown: blends in well with stable wooden fence situations

Art. No.	Designation	Width	Reel	Max. fence length*	Breaking load	Number of conductors	TLDmax	Resistance	Colour	Unit	EAN
125H17116	ranger® FLUO T12	12 mm	200 m	9,100 m	~ 60 kg	4	0.22 mm	0.33 Ω/m		1	4 014803 171160
125H17113	ranger® T12 - W	12 mm	200 m	9,100 m	~ 60 kg	4	0.22 mm	0.33 Ω/m		1	4 014803 171139
125H17114	ranger® T20 - W	20 mm	200 m	11,100 m	~ 120 kg	5	0.22 mm	0.27 Ω/m		1	4 014803 171146
125H17115	ranger® T40 - W	40 mm	200 m	15,000 m	~ 180 kg	8	0.20 mm	0.20 Ω/m		1	4 014803 171153
125H17125	ranger® T40 - B-E	40 mm	200 m	15,000 m	~ 260 kg	8	0.20 mm	0.20 Ω/m		1	4 014803 171252



ELECTRIC FENCE ROPE

horizont electric fence ropes are available in different series, which are characterized by the maximum fence length. horizont offers the appropriate electric fence rope for every individual application. When choosing the conductor material, observe the diameter and colour for optimum herding security.

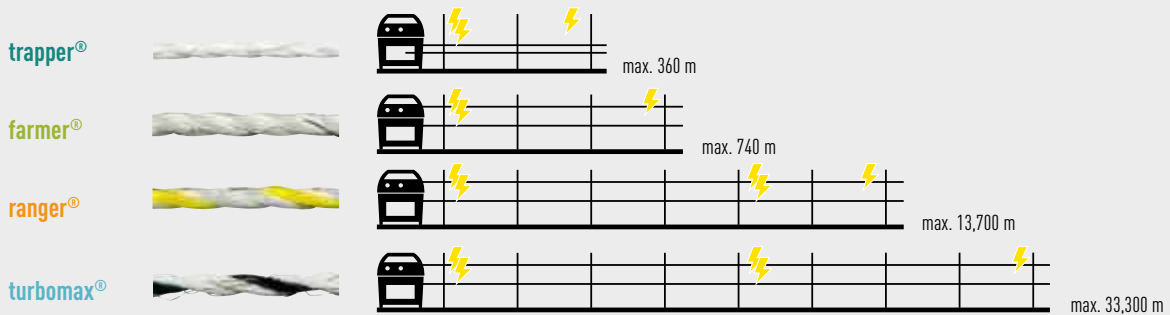

Maximum fence lengths: The length specifications show the maximum possible fence length of a level without vegetation with an appropriately strong energiser.

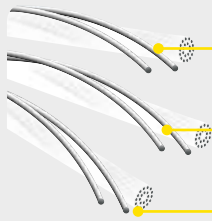

The counter-rotating stranding ensures a high stability of the electric fence rope.

Individual strands are arranged so that they are well twisted into the rope. This ensures a safe spark-over.

Due to the complex stranding process, wires are always clearly visible and offer a high contact surface.

Electric fence rope farmer®

- Suitable for:** • Short fences and strip grazing with little vegetation
- Advantage:** • 125H462560: The elasticity of the horizont fence rope makes it ideal for use on pasture gates in combination with gate handles
- Colour:** • White: for more contrast to the surroundings and increased visibility in twilight and darkness



Art. No.	Designation	Diameter	Reel	Max. fence length*	Breaking load	Number of conductors	Ø Stainless steel conductor	Resistance	Colour	Unit	EAN
125H153372	farmer® R6	6 mm	200 m	740 m	~ 250 kg	6	0,20 mm	4,05 Ω/m	○	1	4 014803 438034
125H153372400	farmer® R6	6 mm	400 m	740 m	~ 250 kg	6	0,20 mm	4,05 Ω/m	○	1	4 014803 438041
125H462560	farmer® stretch W3	8 mm	50 m	370 m	~ 100 kg	3	0,20 mm	8,10 Ω/m	◐	1	3 485630 025604

*Fence length: Specification for simple fences with one conductor and without vegetation. Depending on the amount of vegetation, this will reduce the specified fence lengths. If using several fence conductors on several levels, longer fences are possible.

HORIZONT FENCE | Conductor material | Electric fence rope



Electric fence rope ranger®

Suitable for:

- Medium to long fences
- High number of wires ensures high current flow
- Polyethylene threads with high tensile strength

Advantage:

Colour:

- White: for more contrast to the surroundings and increased visibility in twilight and darkness
- Green: blends in well with nature

Art. No.	Designation	Diameter	Reel	Max. fence length*	Breaking load	Number of conductors	TLDmax	Resistance	Colour	Unit	EAN
125H17182	ranger® R6	6 mm	200 m	13,700 m	~ 250 kg	6	0,22 mm	0.22 Ω/m	○●	1	4 014803 171825
125H17182400	ranger® R6	6 mm	400 m	13,700 m	~ 250 kg	6	0,22 mm	0.22 Ω/m	○●	1	4 014803 438010



Electric fence rope turbomax®

Suitable for:

- Long to very long fences with dense vegetation
- The **TLDmax** conductors ensure highest conductivity and secure a high current flow
- High tensile strength for long outdoor use
- PE monofilaments for long durability

Advantage:

Colour:

- White/black: for more contrast to the surroundings and increased visibility in twilight and darkness

Art. No.	Designation	Diameter	Reel	Max. fence length*	Breaking load	Number of conductors	TLDmax	Resistance	Colour	Unit	EAN
125H17180	turbomax® R6-PE	6 mm	200 m	17,700 m	~ 500 kg	6	0,25 mm	0.17 Ω/m	○●	1	4 014803 171801
125H17180400	turbomax® R6-PE	6 mm	400 m	17,700 m	~ 500 kg	6	0,25 mm	0.17 Ω/m	○●	1	4 014803 431998
125H17180800	turbomax® R6-PE	6 mm	800 m	17,000 m	~ 500 kg	6	0,25 mm	0.17 Ω/m	○●	1	4 014803 438003



TIP:
 horizont electric fence polywires are particularly lightweight and can therefore be easily tensioned and installed. The low weight allows large distances between posts in the fence system.

ELECTRIC FENCE POLYWIRE

horizont electric fence polywires are available in different series, which are characterized by the maximum fence length. horizont offers the appropriate electric fence polywire for every individual application. All horizont electric fence wires are clearly visible at twilight, which is important due to the small diameter.

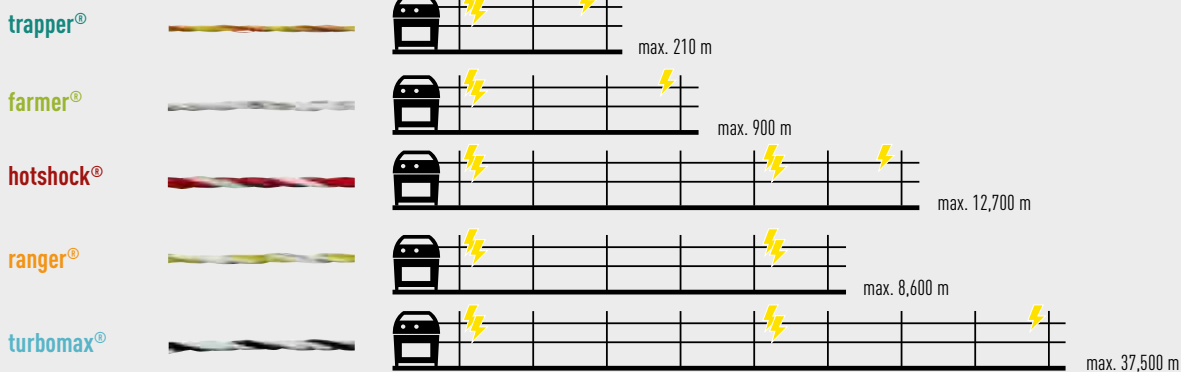

Maximum fence lengths: The length specifications show the maximum possible fence length of a level without vegetation with a correspondingly powerful energiser.

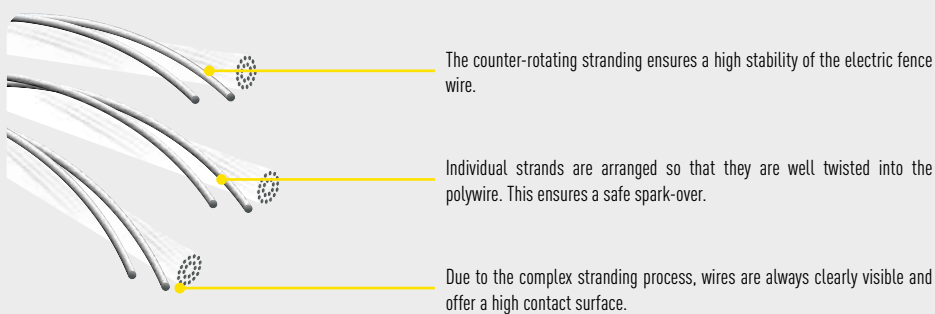

*Fence length: Specification for simple fences with one conductor and without vegetation. Depending on the amount of vegetation, this will reduce the specified fence lengths. If using several fence conductors on several levels, longer fences are possible.

Electric fence polywire trapper®



- Suitable for:** - Short fences and strip grazing
Advantage: - Simple quality optimal for the hobby sector
Colour: - Yellow/ orange: good visibility for animal and human

Art. No.	Designation	Reel	Max. fence length*	Breaking load	Number of conductors	∅ Stainless steel conductor	Resistance	Colour	Unit	EAN
125H15567	trapper® W3	250 m	210 m	~ 30 kg	3	0,15 mm	14,4 Ω/m	●●	1	4 014803 155672
125H15849	trapper® W3	500 m	210 m	~ 30 kg	3	0,15 mm	14,4 Ω/m	●●	1	4 014803 158499

Electric fence polywire farmer®



- Suitable for:** - Short to medium fences
Advantage: - Average breaking loads
 - Double the amount of monofilaments compared to a standard quality
Colour: - White: for more contrast to the surroundings and increased visibility in twilight and darkness
 - Yellow/orange: good visibility for animal and human

Art. No.	Designation	Reel	Max. fence length*	Breaking load	Number of conductors	∅ Stainless steel conductor	Resistance	Colour	Unit	EAN
125H15347	farmer® W9 - W	250 m	900 m	~ 70 kg	9	0,18 mm	3,33 Ω/m	○	1	4 014803 153470
125H15277	farmer® W9 - W	400 m	900 m	~ 70 kg	9	0,18 mm	3,33 Ω/m	○	1	4 014803 152770
125H15282	farmer® W6 - W	250 m	600 m	~ 60 kg	6	0,18 mm	4,98 Ω/m	○	1	4 014803 152824
125H15283	farmer® W6 - W	400 m	600 m	~ 60 kg	6	0,18 mm	4,98 Ω/m	○	1	4 014803 152831
125H15345	farmer® W3 - O	250 m	300 m	~ 50 kg	3	0,18 mm	9,99 Ω/m	●●	1	4 014803 153456

Electric fence polywire hotshock®



The HOTSHOCK W6 400 m HORIZONT wire is very resistant. It ensures a better conductivity thanks to the use of TBmax conductors.

The wires are made of polyethylene, which gives them a reinforced protection against UV rays, allowing them a longer life and a high resistance to breakage.

They are specially designed to withstand the high power of the HOTSHOCK energizers, to keep sheep and fight against game and various wild animals.

3-year warranty on UV resistance.

Art. No.	Designation	Reel	Number of conductors	Conductor	∅ Stainless steel conductor	Line resistance	Breaking load: approx.	Colour	Unit	EAN
125H17208	hotshock® W6	400 m	6	∅ 0.30 m	0.18 mm	3,356 Ω/m	100 kg	○●	8	4 014803 172082
125H17209	hotshock® W9	400 m	9	∅ 0.30 m	0.18 mm	3,33 Ω/m	120 kg	○●	8	4 014803 172099

Electric fence polywire | ranger®

- Suitable for:** • Medium to long fences
- Advantage:** • High conductivity, high tensile strengths and safe and high current flow
- Colour:** • White/yellow: for more contrast to the surroundings and increased visibility in twilight and darkness
 • Orange/grey: good visibility for animal and human
 • Yellow/blue/green: fluorescent effect, especially good visibility against darker backgrounds like forests



Art. No.	Designation	Reel	Max. fence length*	Breaking load	Number of conductors	TLDmax	Resistance	Colour	Unit	EAN
125H17143	ranger® W3 - 0	200 m	8,6 km	~ 160 kg	3	0,25 mm	0,35 Ω/m	●●●	1	4 014803 171436
125H17143400	ranger® W3 - 0	400 m	8,6 km	~ 160 kg	3	0,25 mm	0,35 Ω/m	●●●	1	4 014803 437952
125H171431000	ranger® W3 - 0	1000 m	8,6 km	~ 160 kg	3	0,25 mm	0,35 Ω/m	●●●	1	4 014803 437969
125H17144	ranger® W3 - W	200 m	8,6 km	~ 160 kg	3	0,25 mm	0,35 Ω/m	○●●	1	4 014803 171443
125H17144400	ranger® W3 - W	400 m	8,6 km	~ 160 kg	3	0,25 mm	0,35 Ω/m	○●●	1	4 014803 437976
125H171441000	ranger® W3 - W	1000 m	8,6 km	~ 160 kg	3	0,25 mm	0,35 Ω/m	○●●	1	4 014803 437983

Electric fence polywire | turbomax®

- Suitable for:** • Long to very long fences with dense vegetation
- Advantage:** • High conductivity and safe and high current flow
- Colour:** • White/yellow: for more contrast to the surroundings and increased visibility in twilight and darkness



Art. No.	Designation	Reel	Max. fence length*	Breaking load	Number of conductors	TLDmax	Resistance	Colour	Unit	EAN
125H17140	turbomax® W6	200 m	25 km	~ 180 kg	6	0,30 mm	0,12 Ω/m	○●●●	1	4 014803 171405
125H17140400	turbomax® W6	400 m	25 km	~ 180 kg	6	0,30 mm	0,12 Ω/m	○●●●	1	4 014803 437891
125H171401000	turbomax® W6	1000 m	25 km	~ 180 kg	6	0,30 mm	0,12 Ω/m	○●●●	1	4 014803 437907
125H17141	turbomax® W9	200 m	27,3 km	~ 200 kg	9	0,25 mm	0,11 Ω/m	○●●●●	1	4 014803 171412
125H17141400	turbomax® W9	400 m	27,3 km	~ 200 kg	9	0,25 mm	0,11 Ω/m	○●●●●	1	4 014803 437914
125H171411000	turbomax® W9	1000 m	27,3 km	~ 200 kg	9	0,25 mm	0,11 Ω/m	○●●●●	1	4 014803 437921
125H17142	turbomax® W12	200 m	37,5 km	~ 220 kg	12	0,25 mm	0,08 Ω/m	○●●●●●	1	4 014803 171429
125H17142400	turbomax® W12	400 m	37,5 km	~ 220 kg	12	0,25 mm	0,08 Ω/m	○●●●●●	1	4 014803 437938
125H171421000	turbomax® W12	1000 m	37,5 km	~ 220 kg	12	0,25 mm	0,08 Ω/m	○●●●●●	1	4 014803 437945

*Fence length: Specification for simple fences with one conductor and without vegetation. Depending on the amount of vegetation, this will reduce the specified fence lengths. If using several fence conductors on several levels, longer fences are possible.

Electric fence polywire turbomax® braided wire



Suitable for:

- Long to very long fences with dense vegetation
- Mobile fences that are frequently assembled and dismantled

Advantage:

- Strong conductivity due to high number of mixed conductors (copper and stainless steel)
- High number of conductors ensures high current flow
- Braided structure of the plastic monofilaments ensures a high tensile strength and well protected conductor wires, thus achieving long-term resistance
- PE monofilaments for long durability

Colour:

- White/black: for more contrast to the surroundings and increased visibility in twilight and darkness

Art. No.	Designation	Ø	Reel	Max. fence length*	Breaking load	Number of conductors	Ø Stainless steel conductor	Ø Copper conductor	Resistance	Colour	Unit	EAN
125H145121	turbomax® braided wire D3	3 mm	200 m	23,1 km	~ 200 kg	9	6 x 0,15 mm	3 x 0,25 mm	0,13 Ω/m	☉	1	4 014803 467430
125H145121400	turbomax® braided wire D3	3 mm	400 m	23,1 km	~ 200 kg	9	6 x 0,15 mm	3 x 0,25 mm	0,13 Ω/m	☉	1	4 014803 467447





TIP:

Electric fence wires are particularly suitable for electric permanent fences installations. Horizontal electric fence wires are characterized above all by their high conductivity and durability.

ELECTRIC FENCE WIRE

Horizontal electric fence wires are available in different series, which are characterized by the maximum fence length. HORIZONT offers the appropriate electric fence wire for every individual application. For optimum herding security, observe the diameter and processing (solid or coiled wire) when choosing the conductor material.

Original control wire



Steel wire



Stranded wire

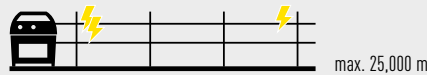

Permanent fencing GALVADUR



Maximum fence lengths: The length specifications show the maximum possible fence length of a level without vegetation with a correspondingly powerful energiser.

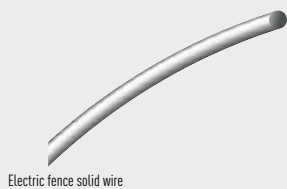

Electric fence solid wire

HORIZONT offers electric fence solid wires with different diameters and highest conductivity. They are very easy to shape, are corrosion resistant, easy to process, enormously resilient and suitable for long fences.

The electric fence polywire consists of many different individual, e.g. galvanized wire strands. It is easy to process, is suitable for long fences and is particularly tear-resistant.

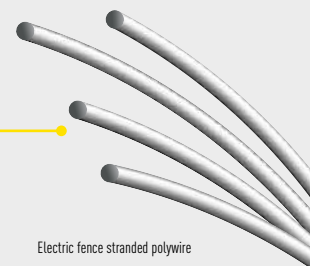

Electric fence stranded polywire

*Fence length: Specification for simple fences with one conductor and without vegetation. Depending on the amount of vegetation, this will reduce the specified fence lengths. If using several fence conductors on several levels, longer fences are possible.

HORIZONT FENCE | Conductor material | Electric fence wire

14134



Electric fence wire | Stranded wire

- Suitable for:** • Medium fence lengths
Advantage: • 7 wires wound into one conductor
 • Wire is particularly flexible

Art. No.	Designation	Diameter	Reel	Max. fence length*	Breaking load	Number of conductors	Resistance	Material	Unit	EAN
125H14134400	Stranded wire	1.5 mm	400 m	25,0 km	~ 200 kg	7	0,12 Ω/m	galvanized	1	4 014803 438102

125H15904



Electric fence wire | Permanent fencing GALVADUR

- Suitable for:** • Long fences
Advantage: • The utilised steel wire is thickly galvanized with a special zinc/aluminium long-term protection (95 % zinc and 5 % aluminium)
 • This achieves a high level of corrosion protection and considerably extends the durability

Art. No.	Designation	Diameter	Reel	Max. fence length*	Breaking load	Number of conductors	Resistance	Material	Unit	EAN
125H15904	GALVADUR	1,6 mm	315 m	50,0 km	~ 200 kg	1	0,06 Ω/m	galvanized	1	4 014803 159045
125H15945	GALVADUR	2,5 mm	625 m	75,0 km	~ 500 kg	1	0,04 Ω/m	galvanized	1	4 014803 159458

ACO wire

- Galvanized steel single cord.
- Conductors: galvanized braided wires with a diameter of 1.2 mm
- Length: 200 m reel
- Linear resistance: 0.9 Ohm/m
- Breaking load: approx. 150 k



125H13011400

Art. No.	Length	Unit	EAN
125H13010	200 m reel Limited stock	6	3 700393 916052
125H13011400	400 m reel Limited stock		4 014803 438355

Electric fence connectors

- Application:**
- Easy and safe to use in the electric fence tape
 - Simple re-tensioning possible
- Advantage:**
- Stable electric fence tape connector through one-piece galvanized metal brackets supported by break-proof plastic



Art. No.	Suitable for	Width	Material	Unit	EAN
125H14988	Electric fence tapes	up to 20 mm	galvanized, plastic	10	3 700393 916632
125H14987	Electric fence tapes	up to 40 mm	galvanized, plastic	5	3 700393 916625



Electric fence rope/polywire connector

- Application:**
- For connection of electric fence polywires or ropes
- Advantage:**
- Large contact surface

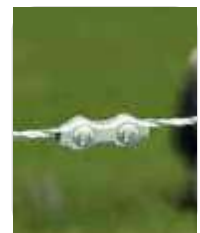

Art. No.	Suitable for	Diameter	Material	Unit	EAN
125H15063	Electric fence polywires	1-4 mm	galvanized steel	10	4 014803 405388
125H15483	Electric fence ropes	4-6 mm	galvanized steel	5	4 014803 405746

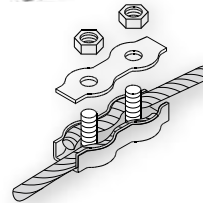

Electric fence tape connecting cable

- Application:**
- Screw-on
 - Connects overlapping tapes
 - Cable length 50 cm

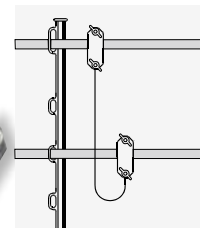

Art. No.	Suitable for	Width	Material	Unit	EAN
125H10446	Electric fence tapes	up to 40 mm	Stainless steel	1	3 700393 916496



40 mm

Electric fence polywire connecting cable

- Application:**
- For the connection of electric fence polywires stretched over each other
 - Cable length 50 cm
- Advantage:**
- All high voltage cables with double insulation



Art. No.	Suitable for	Material	Unit	EAN
125H10440	Electric fence ropes and wires	galvanized steel, plastic	2	3 700393 916472



50 cm



20 mm



Zinc Coated

FE / ZN



Electric fence wire connector and tensioner Gripple

- Application:**
- Can also be used as wire tensioner
 - 4 times faster than knotting or such
 - Holds tension for a long time and is easy to re-tension
 - Easy to mount with Gripple tensioning tool with tension meter (125H15962)

Art. No.	Suitable for	Diameter	Material	Unit	EAN
125H15967	Electric fence solid wires	1,4-2,2 mm	galvanized	20	3 700393 916953
125H47GRIP0001	Electric fence solid wires	2,0-3,25 mm	galvanized	20	3 700393 916960



Aluminium

FE / ZN



Electric fence rope tensioner

- Application:**
- Tensioner can be mounted directly into the fence material at any point of the fence
- Advantage:**
- Complete with locking bracket

Art. No.	Suitable for	Diameter	Material	Unit	EAN
125H15937	Electric fence ropes and wires	1-8 mm	Aluminium	2	3 700393 916922
125H15937025	Electric fence ropes and wires	1-8 mm	Aluminium	25	4 014803 413192



PP
Polypropylen



Electric fence polywire/rope tensioner

- Application:**
- Easy to use
 - Easy re-tensioning possible any time
 - High tensioning effect

Art. No.	Suitable for	Diameter	Material	Unit	EAN
125H14991	Electric fence ropes, polywires	6-13 mm	Polypropylene	2	4 014803 149916



Zinc Coated

Stainless Steel

FE / ZN

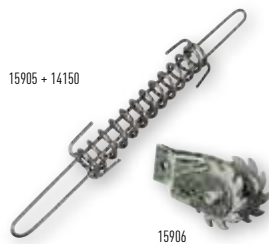

Electric fence wire tensioner | Accessories

- Application:**
- Keeps the wire taut during temperature fluctuations

Art. No.	Suitable for	Material	Unit	EAN
125H14150	Electric fence wires	hot-dip galvanized steel	2	4 014803 141507
125H15906	Electric fence wires	hot-dip galvanized steel	2	3 700393 919534



FE / ZN



Electric fence tensioning tool | Gripple

- Application:**
- For tensioning the wire with the Gripple wire connector (125H15967, 125H47GRIP0001)
 - Up to 400 kg tension can be applied to wires
 - Regulation of the tension force through integrated tension measurement

Art. No.	Suitable for	Unit	EAN
125H15962	Electric fence tensioning tool	1	5 038006 012548



Zinc Coated

FE / ZN



Electric fence tightening tool

- Application:**
- For tightening the rope or wire in conjunction with the electric fence wire tensioner (Art. No. 125H15937)

Art. No.	Suitable for	Material	Unit	EAN
125H15936	Electric fence tightening tool	galvanized steel	1	4 014803 159366

Reel for wire

- Application:** • For winding and unwinding
- Capacity:** • Electric fence wire GALVADUR Ø 2,5 mm (125H15945): up to max. 625 m
- Brake:** • Via a screw
- Advantage:** • Incl. supporting foot
- Material:** • Galvanized steel



FE / ZN

Art. No.	Unit	EAN
125H15933	1	4 014803 159335

Reel | MAXI ROLLER 2000 & 4000

- Application:** • For winding and unwinding
- Capacity:** • Electric fence polywire: up to max. 2000 m (125H15013) / 4000 m (125H15839)
• Electric fence tape: up to max. 750 m (125H15013) / 1500 m (125H15839)
- Guide:** • Yes
- Brake:** • Yes
- Material:** • Plastic, with conical shaft



Art. No.	Designation	Unit	EAN
125H14068	Reel 4000 m	1	4 014803 140685
125H15013	Replacement roll for MAXI ROLLER 2000	1	4 014803 150134
125H15839	Replacement roll for MAXI ROLLER 4000	1	4 014803 158390



Reel | SUPER ROLLER 1000

- Application:** • For winding and unwinding
- Capacity:** • Electric fence polywire: up to max. 600 m
• Electric fence tape: up to max. 200 m
- Guide:** • Yes
- Brake:** • Yes
- Material:** • Plastic, with hooking in device

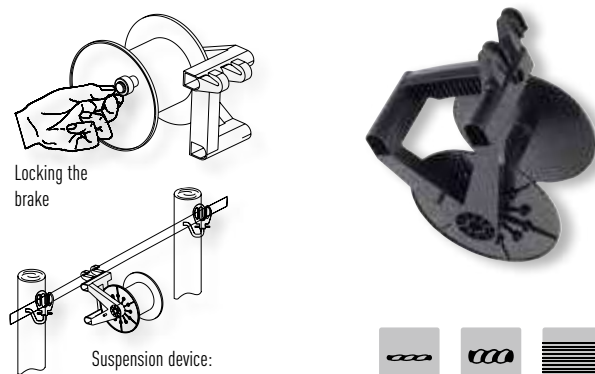

Locking the brake

Suspension device:
Clipping the reel onto the fence material



Art. No.	Unit	EAN
125H14168	1	4 014803 141682

Reel | TURBO ROLLER 3: 1

- Application:** • For winding and unwinding
- Capacity:** • Electric fence polywire: up to max. 800 m
• Electric fence tape: up to max. 300 m
- Guide:** • Yes
- Brake:** • Yes (trailing and parking brake)
- Material:** • Impact-resistant plastic, robust steel crank and steel frame with suspension eyes
- Advantages:** • Roll-back lock, suspension eyes



Art. No.	Designation	Unit	EAN
125H13041	Plastic reel	1	4 014803 130419

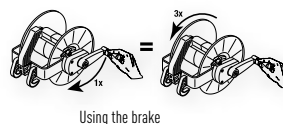

Using the brake

THINGS TO KNOW ABOUT

POSTS

1. WHAT ARE THE DIFFERENT PURPOSES OF POSTS?

CORNER AND GATE POSTS

Corner and gate posts are usually made of wood or recycled material. They are used when the fence direction changes significantly, for example, if you need to integrate a change of direction / corner (more than 30 degrees) into your fence system. Plastic posts cannot sustain the high tensile forces of the fence system as corner posts and are therefore unsuitable for this area of application. Sturdy wood posts are useful; when assembling a corner, make sure you also use the right accessories; use insulators for wood and recycled posts from horizon. Wood posts are also suitable as intermediate posts for long, straight fence sections; in this case, we recommend using them to make the fence system sufficiently stable and secure. If you integrate a gate into your fence, you should also position stable posts at the end of the fence/gate since the last post must bear the tensile force of the fence at the gate.

Regardless of whether you integrate a corner or gate into your fence system, the posts must be anchored deep in the ground to provide sufficient stability in the fence system. The more forces a post must withstand, the deeper it must be anchored in the ground and the larger the post diameter must be.

TIP: Corner, gate and intermediate posts are best anchored in the ground using an earth auger and a post rammer and should be twice as long as the fence is high.

POSTS FOR CHANGING DIRECTION

If the direction of your fence changes (at an angle of 20 to 30 degrees), the post used to change

Corner situation from the side view and top view

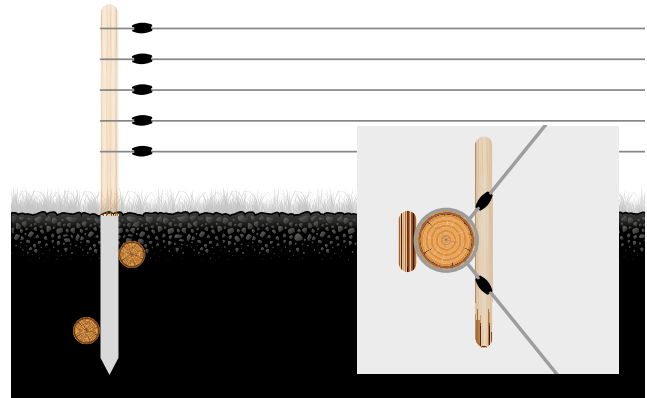

direction need not be as strong as a corner or gate post. The forces acting on the post under this low inclination are not very strong. These poles should also be used in depressions or hills. The most suitable posts for this purpose are those that can be anchored in the ground, such as wooden posts. Recycled plastic posts from horizon are an inexpensive alternative.

LINE POSTS

The function of the line posts is to keep the conductor material at a constant height. The wider the conductor material is (especially when using tapes), the closer together the posts must be positioned. In wind-prone areas, more posts should be placed along one section of the fence to ensure that the fence is stable enough. The utilised conductor material becomes heavier in heavy rain or even in winter, as it absorbs more moisture. This increased weight is not without risk for the herding security in the fence and should be taken into account. To avoid failures or voltage drops, provide a sufficient number of posts in your fence system as a preventive measure. The choice of the appropriate line post differs depending on whether you own a stationary fence or want to build a mobile fencing. For permanent fencing we recommend wood or recycled plastic posts. When utilising mobile fencing, you should use plastic, fibreglass or angle steel posts.

TIP: TILTING POSTS?

Do your posts often tip over? This would pose a high risk for you as a livestock owner and your animals. Line posts have only limited grip in the ground. The correct use of corner posts is therefore important, as they keep the tension secure and stable from corner post to corner post. For plastic posts, a wide and long earth spike is suitable for a better grip in the ground.

Example fence with corner/gate posts e.g. made of wood (brown), line posts e.g. made of plastic (white) and posts for changing direction e.g. made of recycled material (grey)

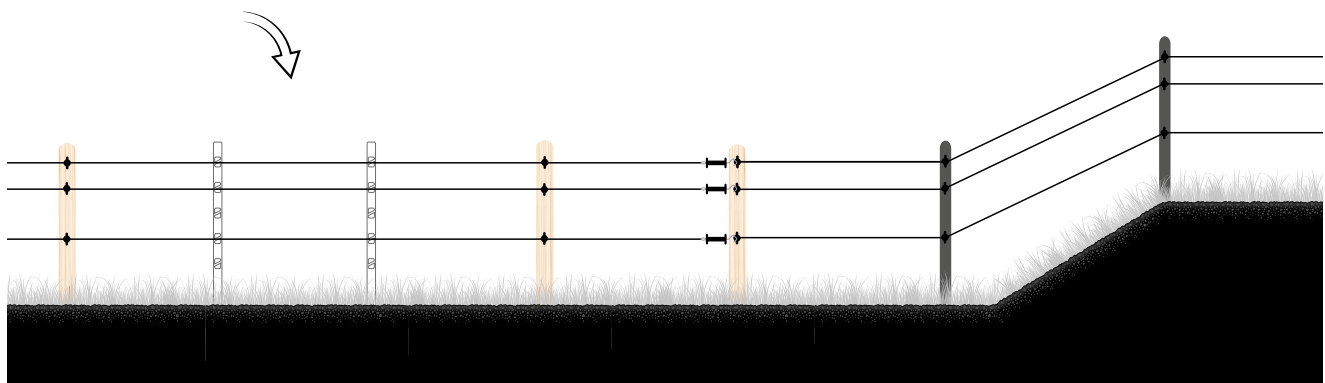

2. HOW HIGH AND HOW FAR APART MUST POSTS BE?

The height of your electric fence depends on the type of animal to be herded. Above all, the size of your animals and their jumping characteristics should be taken into account. If you also keep young animals in the pasture, your fence must be extended downwards.

As a general rule, the wider or heavier the conductor material, the closer together the posts must be in wind-prone regions. The distances also differ from the conductor material used.

TIP

When using plastic posts as line posts, you can easily transfer the heights for the insulators to the corner posts or posts for changes of direction by placing the plastic post in the ground next to the wood or recycling plastic post and transferring the height of the eyes to it.



3. HOW DOES THE INTERACTION OF POSTS AND FENCE LENGTHS WORK?

The following table helps to calculate fence lengths and the number of posts required. It is important to note that stable posts should be used for each corner and gate and where there are major changes in direction or depressions and hills.

Area	Examples of side lengths	Fence length
2,500 m ² / 0,25 ha	50 m x 50 m	200 m
5,000 m ² / 0,5 ha	71 m x 71 m	284 m
7,500 m ² / 0,75 ha	87 m x 87 m	348 m
10,000 m ² / 1,0 ha	100 m x 100 m	400 m
15,000 m ² / 1,5 ha	122 m x 122 m	488 m
20,000 m ² / 2,0 ha	141 m x 141 m	564 m
30,000 m ² / 3,0 ha	173 m x 173 m	692 m
50,000 m ² / 5,0 ha	224 m x 224 m	896 m

EXAMPLE SITUATION: HORSE PASTURE AT THE EDGE OF THE FOREST WITHOUT TERRAIN



This pasture measures 306 m and includes a gate and must also bypass a large boulder. Therefore 6 stable corner posts are needed. For some of the long distances between the posts, line posts should be placed at intervals of 3 m, which keep 3 levels of wide tape at the same height. For a fence length of 300 m you will need 100 line posts, but this does not include the length of the gate (6 m below the boulder here).

Important icons for this chapter:

Cross Selling Icons:

These icons refer to products that are additionally required and are compatible with the selected product.



Insulator



Tape



Polywire



Conductor material



Wire



Rope



Stirrup post

- Eyes suitable for:**
- 4 x wide tapes up to 40 mm, 4 x wide tapes up to 20 mm, 8 x rope up to 8 mm, 8 x polywires up to 3,5 mm and 8 x wires up to 3,5 mm
- Total height:**
- 157 cm
- Height above ground:**
- 142 cm
- Earth spike:**
- 15 cm, Ø 8 mm
- Tread:**
- Stirrup step

Art. No.	Colour	Unit	EAN
125H15108	white	20	4 014803 151087
125H15108GN	white	20	4 014803 432384

Plastic post

• The unique eye construction allows easy insertion of fence material and prevents it from slipping out.



Stirrup post

- Sturdy design
- Of glass fibre reinforced polypropylene
- Reinforced, twist-free profile

Plastic post trapper®

- Extremely lightweight solid plastic post
- Non-twisting profile
- Easy to handle

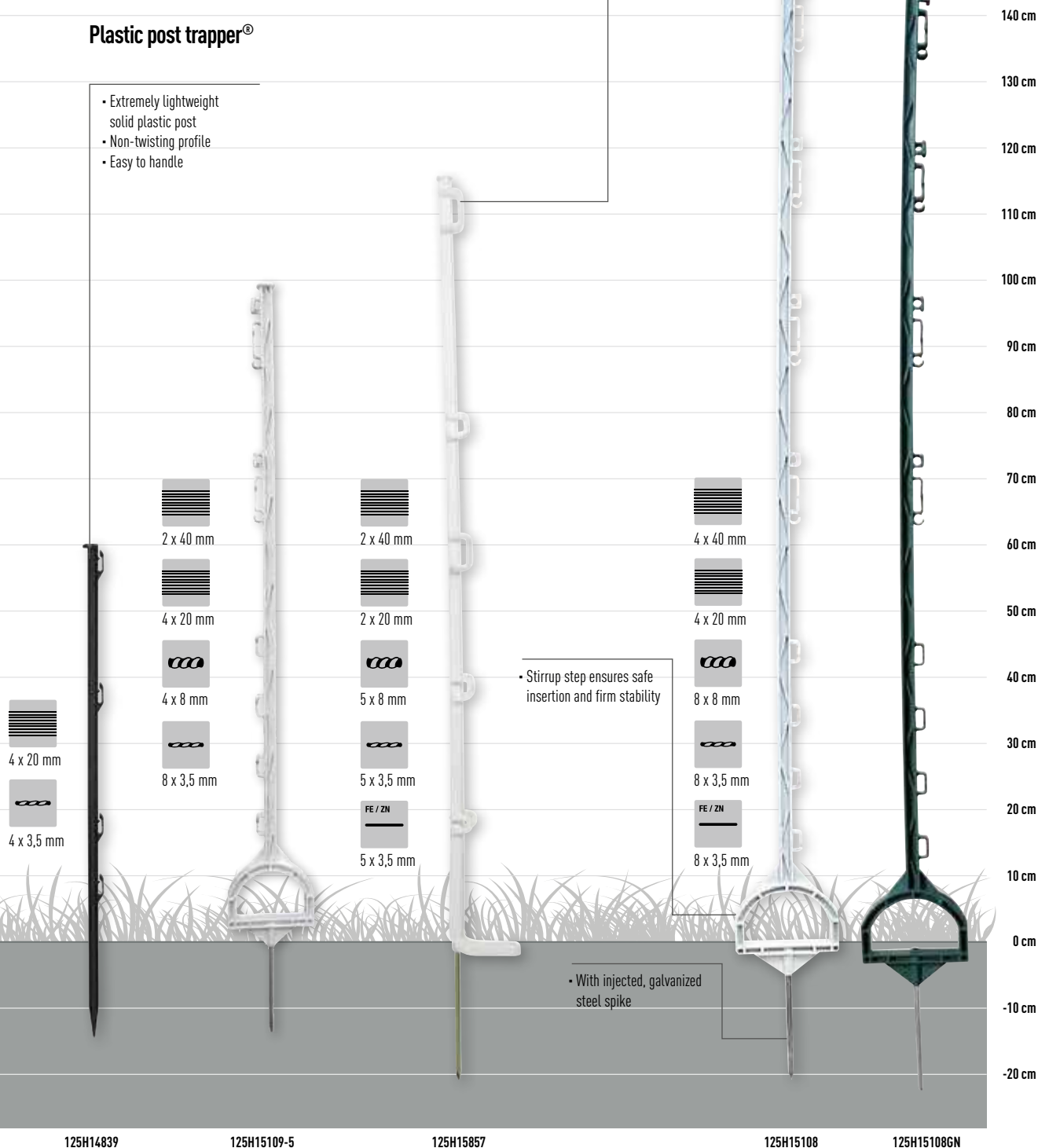

125H14839

125H15109-5

125H15857

125H15108

125H151086N



Plastic post ranger®







- Eyes suitable for:** - 2x wide tape up to 40 mm, 3x wide tape up to 20 mm, 5x polywire up to 3.5 mm
- Total height:** - 71 cm
- Height above ground:** - 58 cm
- Earth spike:** - 13 cm, Ø 7 mm

Art. No.	Colour	Tread	Unit	EAN
125H14471	white	Single tread	 10	 4 014803 465719

- Eyes suitable for:** - 3x wide tape up to 40 mm, 5x wide tape up to 20 mm, 2x rope up to 8 mm, 10x polywire up to 3.5 mm
- Total height:** - 108 cm
- Height above ground:** - 95 cm
- Earth spike:** - 13 cm, Ø 8 mm

Art. No.	Colour	Tread	Unit	EAN
125H14472	white	Single tread	 10	 4 014803 465740
125H14472GN	green	Single tread	 10	 4 014803 465764

- Eyes suitable for:** - 4x wide tape up to 40 mm, 5x wide tape up to 20 mm, 3x rope up to 8 mm, 12x polywire up to 3.5 mm
- Total height:** - 138 cm
- Height above ground:** - 125 cm
- Earth spike:** - 13 cm, Ø 7 mm

Art. No.	Colour	Tread	Unit	EAN
125H14473	white	Single tread	 10	 4 014803 465788
125H14381-5	white	Double tread	 5	 4 014803 465894
125H14473GN	green	Simple tread	 5	 4 014803 465801

Plastic post long life

- Suitable for:** - Insulators for clamping and all types of conductor material
- Total height:** - 146 cm
- Height above ground:** - 125 cm
- Earth spike:** - 21 cm, Ø 9 mm
- Tread:** - Single tread
- Diameter:** - Ø 19 mm

Art. No.	Colour	Unit	EAN
125H15376	white	 10	 4 014803 153760

EXCLUSIVE ADVANTAGES OF THE NEW PLASTIC POSTS:



• Additional lugs

back-friendly guying of the nets and ensures that the post does not twist in the ground

• The post has a particularly stable tread



• Additional ribs in lengthwise direction

• Fits

allow posts to lie securely against each other

• Numbering

for insulators on the post

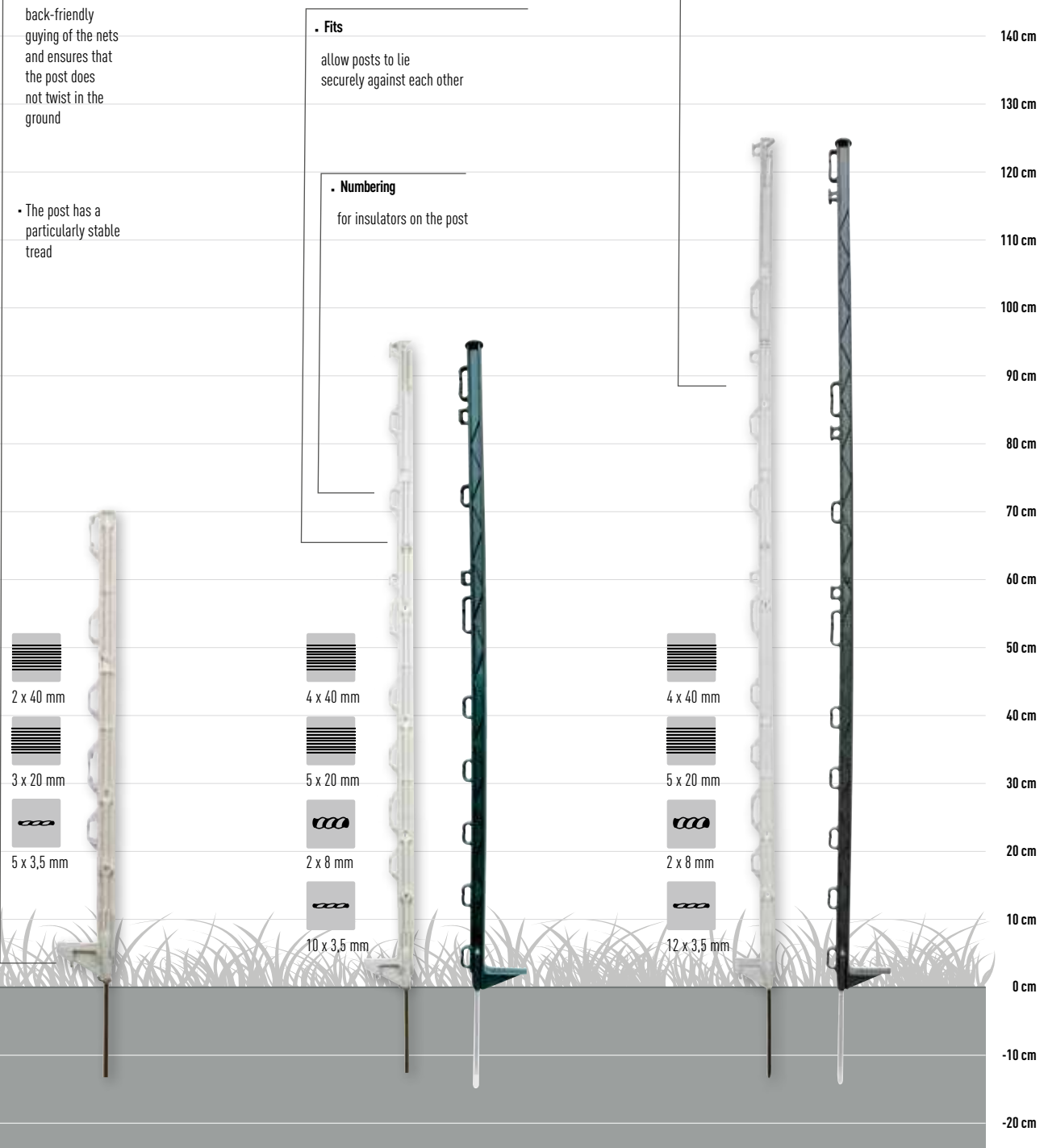

125H14471

125H14472 125H144726N

125H14473 125H144736N

HORIZONT FENCE | Posts | Plastic posts

PLASTIC POST LONG LIFE - A GOOD CHOICE!



- Very high durability – made of a high-quality special plastic, therefore frost-proof
- No seams, as the post is cast in one piece
- Insulators can be individually adjusted in number and height
- Post is sealed at top – water cannot enter

PRODUCT TIP

Insulators are particularly suitable for screwing or clamping / clipping



125H15481

125H15480

Plastic post long life

- A strong, galvanised tread frame provides good stability in hard ground and enables easy insertion into ground
- Continuous welding of the post instead of spot welding makes the earth spike stable



150 cm

140 cm

130 cm

120 cm

110 cm

100 cm

90 cm

80 cm

70 cm

60 cm

50 cm

40 cm

30 cm

20 cm

10 cm

0 cm



-10 cm

-20 cm

125H15376

Plastic post turbomax® smart post



- Eyes suitable for:** • 2 x wide tapes up to 40 mm, 4 x wide tapes up to 20 mm and 6 x polywires up to 3,5 mm
- Total height:** • 78 cm
- Height above ground:** • 55 cm
- Earth spike:** • 23 cm, Ø 9 mm
- Tread:** • Single tread

Art. No.	Colour	Unit	EAN
125H1449010	white	 10	4 014803 450180
125H144905GN	green	 5	4 014803 450210
125H1449010GN	green	 10	4 014803 450241

- Eyes suitable for:** • 3 x wide tapes up to 40 mm, 5 x wide tapes up to 20 mm, 2 x rope up to 8 mm, 10 x polywires up to 3,5 mm
- Total height:** • 115 cm
- Height above ground:** • 92 cm
- Earth spike:** • 23 cm, Ø 9 mm
- Tread:** • Single tread

Art. No.	Colour	Unit	EAN
125H1449110	white	 10	4 014803 144911
125H1449110GN	green	 10	4 014803 450258

- Eyes suitable for:** • 4 x wide tapes up to 40 mm, 6 x wide tapes up to 20 mm, 3 x rope up to 8 mm, 12 x polywires up to 3,5 mm
- Total height:** • 145 cm
- Height above ground:** • 122 cm
- Earth spike:** • 23 cm, Ø 9 mm
- Tread:** • Single tread

Art. No.	Colour	Unit	EAN
125H1449210	white	 10	4 014803 144928
125H144925GN	green	 5	4 014803 450234
125H1449210GN	green	 10	4 014803 450265



HORIZONT FENCE | Posts | Plastic posts

PLASTIC POST TURBOMAX® SMART POST - WITH STRONG ADVANTAGES:



Cross-ribbing in post provides stability, so it can be subjected to higher tensile forces and is difficult to bend

An **additionally reinforced and rounded tread** frame with fluting ensures a firm tread and prevents accidental slipping off

Two insulators at the post tip ensure optimum utilisation of the post length when using polywire, rope or tape up to 40 mm

The **numbering** of the eyes simplifies fence assembly, especially for large pastures

A stable, extra thick galvanized earth **spike** (9 mm diameter, 23 cm length) injected into the post guarantees high durability and ensures secure stability

Plastic post turbomax® smart post

- Of high-quality polypropylene with improved stability and impact resistance
- The shape of the post is based on high, tapered towers; this form provides particularly good stability
- Various designed, extremely stable eyes for tapes, ropes and polywires, suitable for any fence material

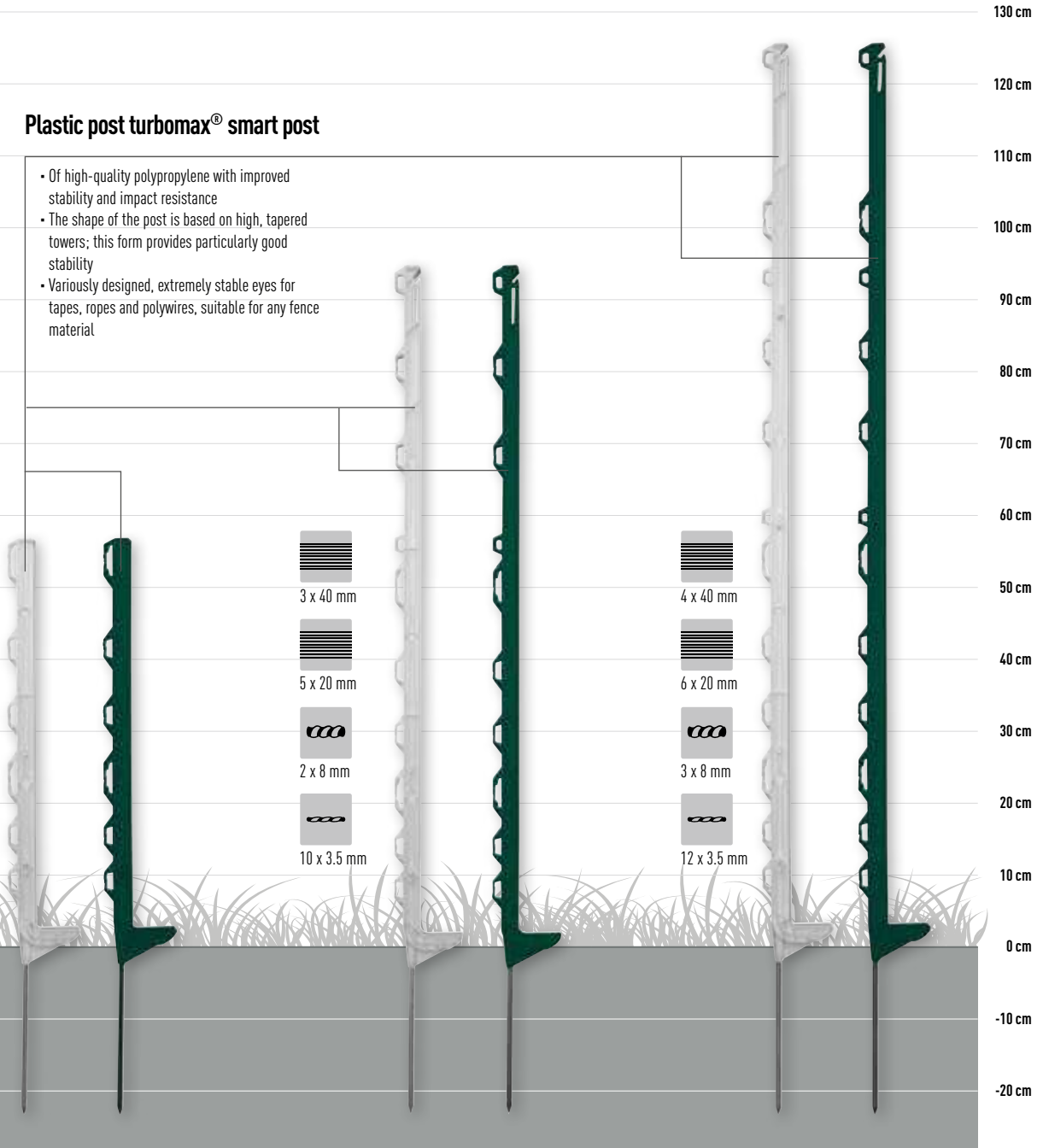

125H14490

125H14490GN

125H14491

125H14491GN

125H14492

125H14492GN

Fibreglass post

- Suitable for:** • Insulators for wide tapes up to 20 mm, rope up to 8 mm and polywires up to 3,5 mm
- Total height:** • 124 cm
- Height above ground:** • 99 cm
- Tread:** • Single tread
- Diameter:** • Ø 12 mm

Art. No.	Colour	Unit	EAN
125H14886	yellow	10	4 014803 148865



Recycled plastic post*

- Suitable for:** • Insulators for screwing in, screwing on and nailing on
- Total height:** • 175 cm
- Height above ground:** • 120 cm
- Diameter:** • Ø 6 cm

Please note: Sold only by the pallet!

Art. No.	Colour	Unit	EAN
125H15593	grey	125	4 014803 155931

YOUR ADVANTAGE:

- Processing with common tools (post does not splinter)
- Manufactured of recycled plastics – can be recycled again
- Unlimited durability guaranteed
- Individual adjustment of holes
- Impregnation not necessary – water cannot enter the post

* Delivery ex works. Please request a non-binding offer for the freight costs.



125H15593

Fibreglass post

- Extremely stable and lightweight
- Particularly easy to handle in terrain
- Insulators can be individually adjusted in number and height

PRODUCT TIP

Insulators are particularly suitable for clamping / clipping



125H14904

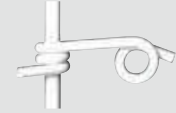

125H17801F

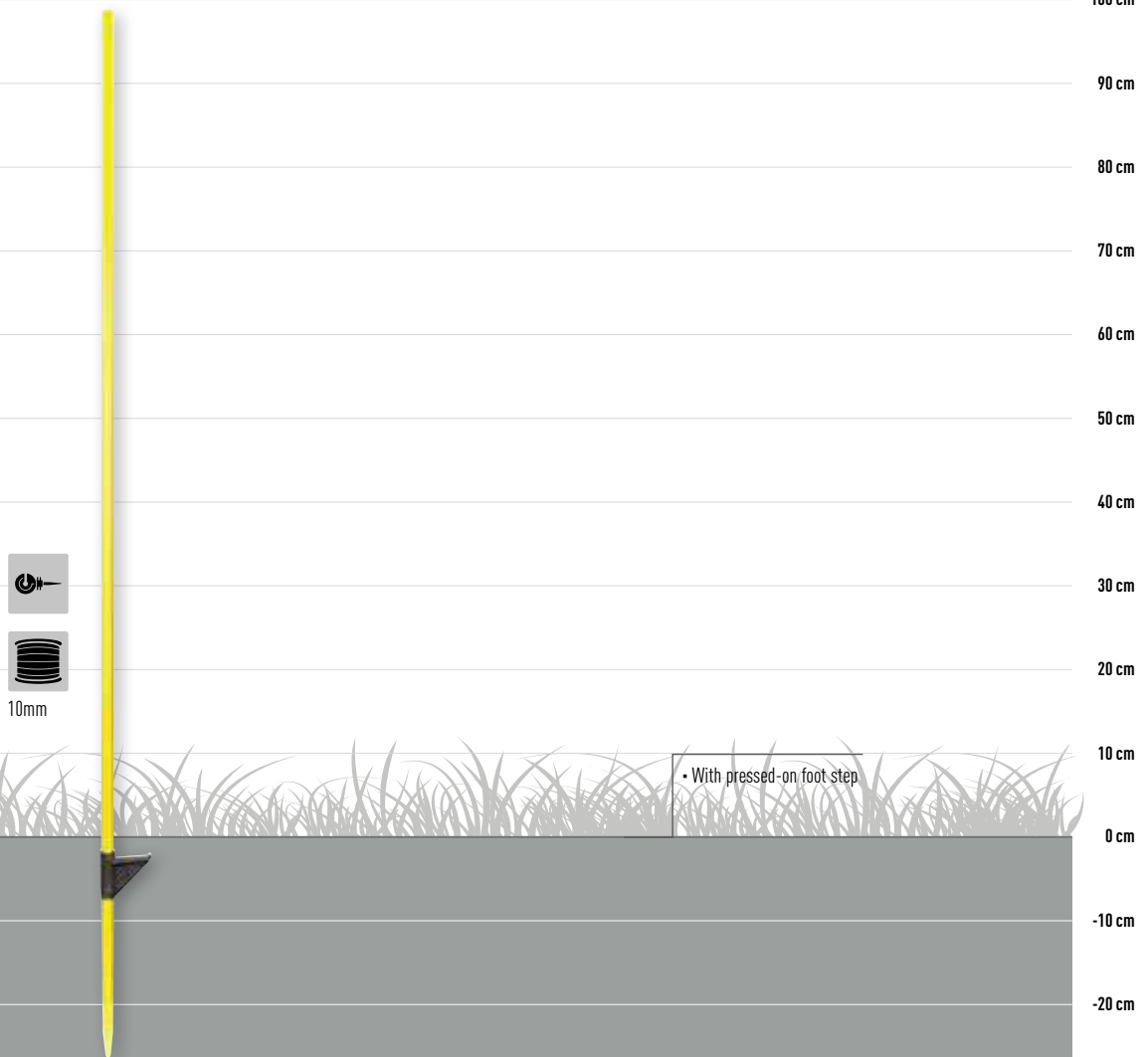

125H14886



Angular steel post

- Suitable for:** • Insulators with split pin or metric thread for polywires up to 3,5 mm
- Total height:** • 115 cm
- Height above ground:** • 95 cm
- Tread:** • Double tread
- Wall thickness:** • 2 mm

Art. No.	Colour	Design	Unit	EAN
125H155361	red	4 bore holes	10	4 014803 155368

- Suitable for:** • Insulators with split pin or metric thread for polywires up to 3.5 mm
- Total height:** • 120 cm
- Height above ground:** • 100 cm
- Tread:** • Double tread
- Wall thickness:** • 3 mm

Art. No.	Colour	Design	Unit	EAN
125H15877	red	4 bore holes	10	4 014803 011794

- Suitable for:** • Insulators with split pin or metric thread for polywires up to 3.5 mm
- Total height:** • 165 cm
- Height above ground:** • 145 cm
- Tread:** • Double tread
- Wall thickness:** • 3 mm

Art. No.	Colour	Design	Unit	EAN
125H152541	red	6 bore holes	10	4 014803 15254 1

Oval steel post with metal eye

- Eyes suitable for:** • 1 x polywires up to 3,5 mm and insulators for screwing on and clamping/clipping for polywires up to 3.5 mm
- Total height:** • 107 cm
- Height above ground:** • 82 cm
- Tread:** • Double tread

Art. No.	Colour	Design	Unit	EAN
125H150561	red	with metal eye	25	4 014803 432810

Oval steel post with ring insulator

- Eyes suitable for:** • 1 x polywires up to 3,5 mm and insulators for screwing on and clamping/clipping for polywires up to 3,5 mm
- Total height:** • 106 cm
- Height above ground:** • 80 cm
- Tread:** • Double tread

Art. No.	Colour	Design	Unit	EAN
125H150551	red	with ring insulator	25	4 014803 432803

Angular steel post

- Extremely stable and durable post
- High stability and secure anchoring in the ground due to angle profile

PRODUCT TIP

Insulators with metric thread or for clamping/clipping are particularly suitable

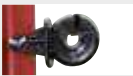

125H158052



125H152932

PRODUCT TIP

Additional insulators for screwing down are suitable for further levels



Oval steep post

- With insulator
- Of twist-free spring steel

- Secure stability due to pressed on tread plate on the post

- Tread frame is through-welded

140 cm
130 cm
120 cm
110 cm
100 cm
90 cm
80 cm
70 cm
60 cm
50 cm
40 cm
30 cm
20 cm
10 cm
0 cm
-10 cm
-20 cm

125H155361

125H15877

125H152541

125H150561

125H150551

THINGS TO KNOW ABOUT

INSULATORS

There are countless fence variants and a suitable insulator is available for nearly every variant. To make it easier to choose the optimal accessory, some criteria should be considered when choosing an insulator.

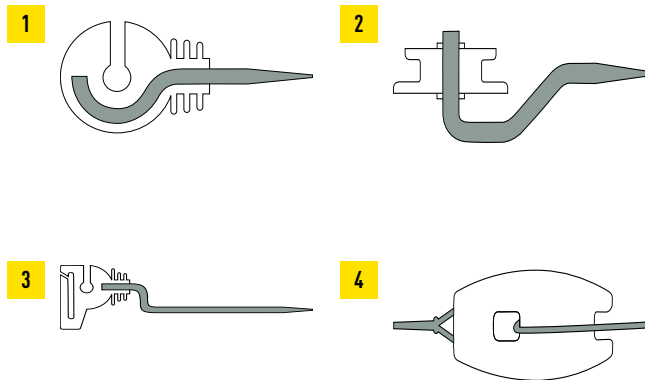

1. IS THERE A SPECIAL FENCING SITUATION YOU NEED TO MASTER WITH YOUR INSULATOR?

1 SECTION/ GUIDE INSULATOR

Section or guide insulators always keep the conductor material at a constant height. The conductor material is guided close to the fence post which makes the fence particularly stable. In addition, their small surface area prevents animals from leaning against or touching the insulators and possibly bending them.

2 CORNER INSULATOR

If you want to build a corner in your fence, we recommend using so-called corner insulators. These can be screwed to the inside of the post. Corner insulators are particularly stable and usually have a metal support inside the insulator which absorbs the tensile forces from the conductor material. As a result, the fence is stable and will not collapse in strong gusts of wind, for example.

3 SPACER INSULATOR

Spacer insulators are less tightly fitted than section /guide insulators, as the guide of the conductor material is further away from the screw-in point of the insulator. They still guarantee good herding security. The use of these insulators prevents direct contact between the animal and the fence. This prevents the animals from leaning against fence posts, for example, and enables the fence to last longer. Spacer insulators are also used to protect solid wood fences, as the animals do not nibble at the wood.

4 STRAIN INSULATOR

Strain insulators are used at the start and end of a fence section or in corners. They are particularly suitable for use with ropes (with a diameter of up to 8 mm) or wire.

2. WHICH CONDUCTOR MATERIAL MUST THE INSULATOR CARRY?

Depending on the type of animal to be fenced in you have selected the appropriate conductor



NOTE

If you want to fence in animals, attach the spacer insulators on the inside of the pasture. If you want to fend off animals, fasten the insulators on the outside of the pasture.

material for your fence. The horizont range carries insulators for tapes, ropes, polywires and wires. There are even insulators that can carry more than one conductor material. Combined insulators are also available for special application situations; these enable you to install tape, rope or polywire in just one insulator.

Always use the appropriate insulator for your conductor material. Never attempt to install a rope in a ring insulator. Ring insulators are suitable for polywires. Otherwise you are in danger of damaging the conductor material and risk weakening the herding security of the fence system.

3. SHOULD THE CONDUCTOR MATERIAL IN THE INSULATOR RUN FREELY OR BE FIXED?

Conductor material is usually fixed in places where strong wind can occur. The conductor material can be fastened by closing the insulator or by using a screw. These variants enable the tight fit of the conductor material. Insulators with free-running conductor material are used for stable corner posts or as section/ guide insulators. The advantage is that the conductor material can be stretched over long distances because it can move freely in the insulator. If fixed insulators were to be used, the conductor material would have to be readjusted on each individual insulator.



Tape runs free!



Tape is fixed!

4. HOW IS AN INSULATOR MOUNTED?

Important: Always select the appropriate insulator in relation to your post. The Product Guide will help you here:



SCREW IN

If insulators are to be fastened in wood, plastic or on stone walls, use insulators that can be screwed in, bolted, nailed or fastened with a special staple.

The horizont range includes special insulators with a unique screw thread for screwing into e.g. wood posts. This special thread prevents annoying splintering of the wood post. For you, the time-consuming process of pre-drilling or countersinking is no longer necessary. Because of the low splintering of the wood – after the insulator has been attached – an extremely secure fit can be guaranteed and herding security be established in your pasture.



SCREWING / NAILING

If you prefer insulators without support, it is best to use insulators that can be nailed or fastened with special staples or screws. These are best attached to wood posts. Insulators with separate metric thread can - in addition to materials such as wood, plastic or stone - also be easily attached to drillable materials such as metal. Just as with the insulators for screwing in, a securely tight fit on the post is possible here.



CLAMPS

Depending on the type of post you use, we also carry insulators for clamping, clipping or inserting. No additional tools are necessary for installation. The insulators can be mounted directly on the post very quickly and easily.

Important icons for this chapter:

Product describing icons:

These icons describe insulator features.

Conductor material runs free	Conductor material is fixed	Section/ guide insulator	Corner insulator	Length of support
Continuous support	Short support	Diameter support	UV resistant	Polycarbonates
Tape	Rope	Polywire	Wire	

Cross Selling Icons:

These icons refer to products that are additionally required and are compatible with the selected product.



Tape insulator | corner 40 plus

- Suitable as:** • Starting/corner insulator
Conductor material: • Tape up to 40 mm
Fastening: • Nailing or screwing to wood or recycled posts with at least two 5 mm screws
Advantage: • Conductor material cannot "fall" out of the insulator even when it is not under tension
 • Easy re-tensioning possible
Application: • Fixed
Scope of delivery: • Screws, bracket

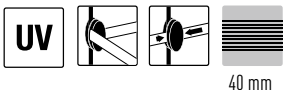

Art. No.	Material	Unit	EAN
125H15299	galvanized	5	3 700393 919619



Tape insulator | combi 40

- Suitable as:** • Section insulator, spacer insulator
Conductor material: • Tape up to 40 mm, polywire up to 4 mm, rope up to 8 mm
Fastening: • Screwing in to wood or recycled plastic posts
Advantage: • Large dry room = High insulation
Application: • Free running
Support: • Short, Ø 6 mm

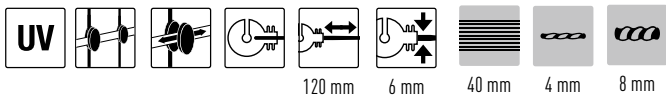

Art. No.	Unit	EAN
125H15828	15	3 700393 916878



Tape insulator combi 40

- Suitable as:** • Section insulator, starting/corner insulator
Conductor material: • Tape up to 40 mm, polywire up to 4 mm, rope up to 8 mm
Fastening: • Screwing in to wood or recycled plastic posts
Advantage: • Large dry room = High insulation
Application: • Free running
Support: • Short, Ø 6 mm

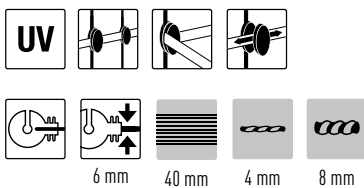

Art. No.	Colour	Unit	EAN
125H15390	black	30	3 700393 916748
125H15390080	black	80	4 014803 413147



Tape insulator ranger® 40 fix

- Suitable as:** • Section insulator
Conductor material: • Tape up to 40 mm, rope up to 8 mm
Fastening: • Nailing or screwing to wood or recycled plastic posts
Advantage: • Strongly interlocked closure support on tape, which provides a secure hold
Application: • Fixed

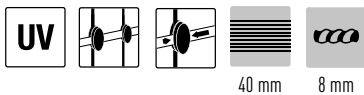

Art. No.	Unit	EAN
125H14990	15	3 700393 916649
125H14990080	80	4 014803 446534

Tape insulator ranger® 40

- Suitable as:** • Section insulator
- Conductor material:** • Tape up to 40 mm
- Fastening:** • Nailing or screwing to wood or recycled plastic posts with two 5 mm screws
- Application:** • Fixed
- Scope of delivery:** • Plastic screws



Art. No.	Design	Unit	EAN
125H14161030	without rubber insert	30	4 014803 428929

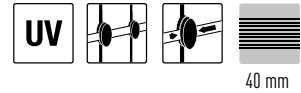

Tape insulator turbomax® plus

- Suitable as:** • Section insulator, starting/corner insulator
- Conductor material:** • Tape up to 40 mm, polywires up to 4 mm, rope up to 8 mm
- Fastening:** • Nailing or screwing to wood or recycled plastic posts with two 5 mm screws
- Application:** • Fixed

Art. No.	Design	Unit	EAN
125H15843	with connecting plate can be used as gate handle insulator <i>Limited stock</i>	1	4 014803 405470

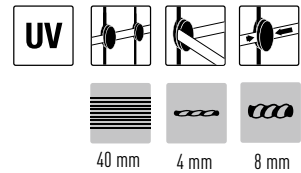
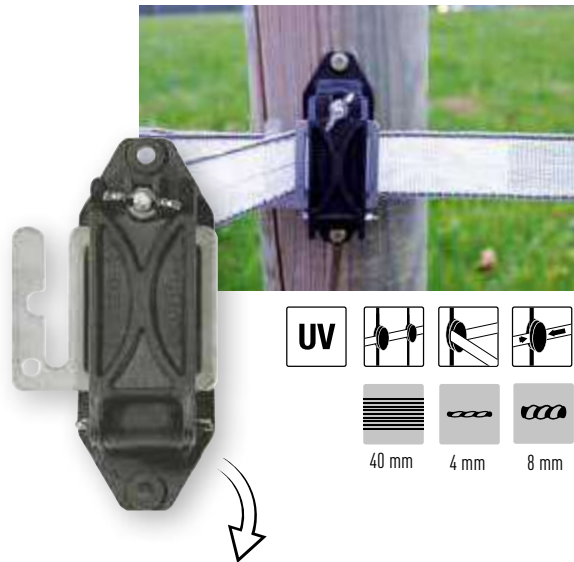

YOUR ADVANTAGE:

- This design is unique on the **market** and offers many advantages.
- The insulator can be opened and **closed very easily**.
- The screw is **fixed firmly** to the insulator so that it can be swivelled, making installation child's play.
- The non-rusting metal connecting plate can even be fitted with a **gate handle**.
- And **fence branches can also be easily** created.



Rope insulator turbomax®

- Suitable as:** • Section insulator, starting/corner insulator
- Conductor material:** • Polywire up to 4 mm, rope up to 8 mm, wire up to 2,5 mm
- Fastening:** • Screwing in to wood or recycled plastic posts
- Advantage:** • Ergonomic shape for optimal handling
- Application:** • Free running
- Support:** • Short, Ø 6 mm

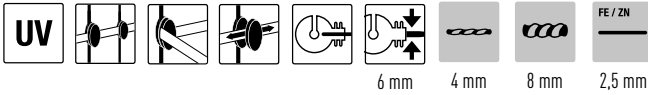

Art. No.	Unit	EAN
125H15835	15	3 700393 916885



Rope insulator turbomax® metric

- Suitable as:** • Section insulator, spacer insulator
- Conductor material:** • Polywire up to 4 mm, rope up to 8 mm
- Fastening:** • Screwing to through holes of e.g. metal posts
- Advantage:** • Large dry room = High insulation
- Application:** • Free running
- Support:** • With metric thread M6, Ø 6 mm

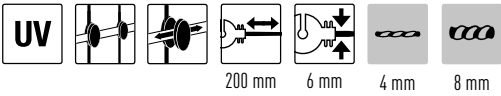

Art. No.	Unit	EAN
125H15073	8	4 014803 456076



Rope insulator flexibar 400 - one side

- Suitable as:** • Section insulator, spacer insulator, strain insulator
- Conductor material:** • Tape up to 40 mm, polywire up to 4 mm, rope up to 8 mm
- Distance:** • Distance to post is 40 cm
- Material:** • Extruded plastic, therefore extremely durable

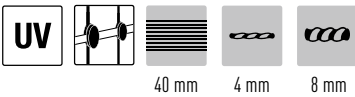

Art. No.	Unit	EAN
125H15318	10 Limited stock	4 014803 153180

Ring insulator trapper® IS-S

- Suitable as:** • Section insulator, corner insulator
Conductor material: • Tape up to 12 mm, polywire up to 4 mm
Fastening: • Screwing in to wood or recycled plastic posts
Application: • Free running
Support: • Continuous, Ø 5,3 mm



Art. No.	Unit	EAN
125H1449350	50	4 014803 144935
125H14493200	200	4 014803 464415

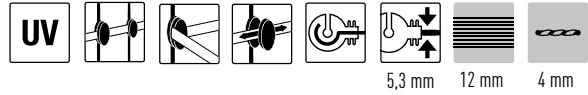

Ring insulator farmer® plus ISL

- Suitable as:** • Section insulator, starting/corner insulator
Conductor material: • Tape up to 13 mm, polywire up to 4 mm
Fastening: • Screwing in to wood or recycled plastic posts
Application: • Free running
Support: • Continuous, Ø 5,3 mm



Art. No.	Unit	EAN
125H15364	50	4 014803 153647



Ring insulator farmer®

- Suitable as:** • Section insulator
Conductor material: • Tape up to 13 mm, polywire up to 4 mm
Fastening: • Screwing in to wood or recycled plastic posts
Application: • Free running
Support: • Short, Ø 5,3 mm



Art. No.	Colour	Unit	EAN
125H15275	black	35	4 014803 456571
125H15275025	black	25	4 014803 420923
125H15275K50	black	50	5 901764 261742
125H15275120	black	120	4 014803 419859
125H15275010	yellow	25	4 014803 417602

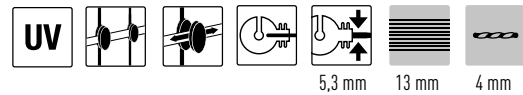

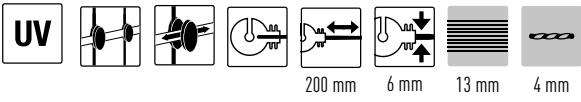

Ring insulator farmer®

- Suitable as:** • Spacer insulator, strain insulator, section insulator
- Conductor material:** • Tape up to 13 mm, polywire up to 4 mm
- Fastening:** • Screwing in to wood or recycled plastic posts
- Application:** • Free running
- Support:** • Short, Ø 6 mm

Art. No.	Unit	EAN
125H14937	8	3 700393 916618

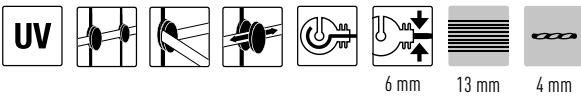

Ring insulator ranger® plus

- Suitable as:** • Section insulator, starting/corner insulator
- Conductor material:** • Tape up to 13 mm, polywire up to 4 mm
- Fastening:** • Screwing in to wood or recycled plastic posts
- Advantage:** • Large dry room = High insulation
• Very high electric strength
- Application:** • Free running
- Support:** • Continuous, Ø 6 mm

Art. No.	Colour	Unit	EAN
125H15370120	black	120	4 014803 002792

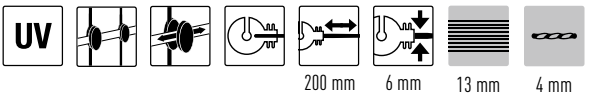

Ring insulator ranger®

- Suitable as:** • Section insulator, spacer insulator, strain insulator
- Conductor material:** • Tape up to 13 mm, polywire up to 4 mm
- Fastening:** • Screwing in to wood or recycled plastic posts
- Advantage:** • Large dry room = High insulation
• Because of the lateral ground position, the tape cannot "fall" out of the insulator unintentionally, even if guided over hill and dale
- Application:** • Free running
- Support:** • Short, Ø 6 mm

Art. No.	Unit	EAN
125H15595	10	3 700393 916816

Wire insulator ranger®

- Suitable as:** • Section insulator, starting/corner insulator
Conductor material: • Polywire up to 4 mm, rope up to 7 mm, wire up to 2.5 mm
Fastening: • Nailing or screwing to wood or recycled plastic posts
Application: • Free running



Art. No.	Unit	EAN
125H15929045	45	4 014803 002938

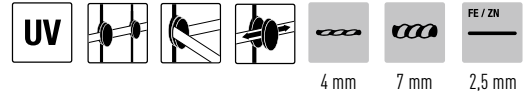

Screw-in aidsh

Insulating tube

- Conductor material:** • Wire
• Rope
Application: • Insulation of wire on wooden posts for electrified fence
Length: • 25 m
Material: • Plastic



125H15935



Art. No.	Diameter	Unit	EAN
125H15935	interior Ø 5 mm, exterior Ø 10 mm	1	4 014803 159359

Screw-in aid

- Suitable for:** • Ring insulators with a wall thickness up to 16 mm
Application: • Easy screwing in of the insulators using a cordless screwdriver



Art. No.	Unit	EAN
125H15357	1	4 014803 431738

Screw-in aid

- Suitable for:** • Ring insulators, rope insulator, gate handle insulators
Application: • Easy screwing in of the insulators using a cordless screwdriver



Art. No.	Unit	EAN
125H14965	1	4 014803 444585

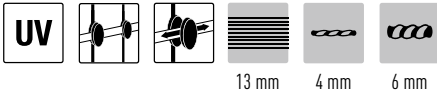

Replacement/additional insulator combi ip-15

- Suitable as:** • Section insulator
Suitable for: • Posts up to Ø 15 mm
Conductor material: • Tape up to 13 mm, polywire up to 4 mm, rope up to 6 mm
Application: • Free running
Note: • Insulator is open at the post attachment

Art. No.	Unit	EAN
125H15290	25	3 700393 916670
125H15290050	50	4 014803 417930

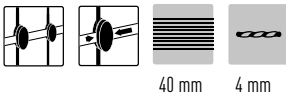

Replacement/additional insulator farmer® 40

- Suitable as:** • Section insulator
Suitable for: • Round posts up to Ø 12 mm
Conductor material: • Tape up to 40 mm, polywire up to 4 mm
Application: • Fixed
Note: • Insulator is closed at post output

Art. No.	Unit	EAN
125H14969025	25	4 014803 444592
125H14969090	90	3 700393 919763

Rope and polywire insulatorsh



Replacement/additional insulator farmer® ip-15

- Suitable as:** • Section insulator
Suitable for: • Posts up to Ø 15 mm
Conductor material: • Polywire up to 4 mm, rope up to 6 mm
Application: • Free running
Note: • Insulator is closed at post output

Art. No.	Unit	EAN
125H15129	20	3 700393 916656
125H1512960	60	4 014803 420541

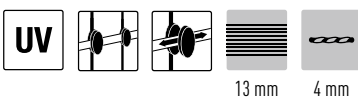

Replacement/additional insulator farmer® fiber

- Suitable as:** • Section insulator
Suitable for: • Posts with Ø 12 mm (125H14886)
Conductor material: • Tape up to 13 mm, polywire up to 4 mm
Application: • Free running

Art. No.	Unit	EAN
125H14046	25	3 700393 916519

Insulators plastic eyelet

The eyelet insulator keeps the wires, ropes and tapes tight and ensures a perfect tension of the fence. It is suitable for the following posts: 125H14886 and 125H14921.

For round posts with a diameter of 12 mm.

- Secure fixing
- For 12 mm diameter tapes
- For 6 mm diameter wires and ropes

Art. No.	Unit	EAN
125H17801F	20	4 014803 178015

By 50



Insulators plastic eyelet

The eyelet insulator keeps the wires, ropes and tapes tight and ensures a perfect tension of the fence. It is suitable for the following posts: 125H14885, 125H14887 and 125H14888.

For round posts with a diameter of 10 mm.

- Secure fixing
- For 12 mm diameter tapes
- For 6 mm diameter wires and ropes

Art. No.	Unit	EAN
125H17804F	20	4 014803 178046

By 50



Ring insulator metric thread ranger®

- Suitable as:** • Section insulator
- Suitable for:** • Angular steel posts with Ø 2-3 mm (125H155361, 125H15877, 125H152541)
- Conductor material:** • Polywire up to 4 mm
- Application:** • Free running
- Support:** • With metric thread M6, thread length of 80 mm

Art. No.	Unit	EAN
125H14167	25	4 014803 141675

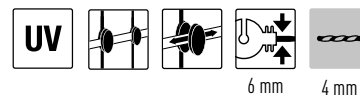

Horizont strain insulator

- Suitable as:** • Stretching insulator
- Conductor material:** • Polywire, ropes and wire
- Application:** • Guying of the fence section
- Material:** • Plastic

Art. No.	Unit	EAN
125H14061	18	3 700393 916526





Gate handle with hook farmer®

- Spring travel limit:** • 3 cm
Material: • Plastic
Fastening: • Eye for conductor material on handle

Art. No.	Colour	Unit	EAN
125H15817002	black	1	4 014803 417848
125H15817019	orange	1	4 014803 417879
125H15817010	yellow	1	4 014803 4158178



Gate handle with hook ranger®

- Spring travel limit:** • 5 cm
Advantage: • Reinforced insulation, therefore suitable for use with powerful equipment
 • Stainless steel rotating pressure spring
Material: • Polycarbonate
Fastening: • Eye for conductor material on handle
Colour: • Transparent dark grey

Art. No.	Unit	EAN
125H14350	1	4 014803 143501



Gate handle with hook and tape connector ranger®

- Spring travel limit:** • None
Advantage: • With the mounted tape connector, a tape up to 40 mm wide can be attached directly to the gate, thus ensuring optimum gate opening
 • The tape can be easily re-tensioned
 • Safe handling due to wide flange
Material: • Plastic
Colour: • Black

Art. No.	Unit	EAN
125H156031	1	4 014803 446541



Gate handle with hook and tape connector turbomax® equistop

- Spring travel limit:** • 8 cm
Advantage: • With the mounted tape connector, a tape up to 40 mm wide can be attached directly to the gate, thus ensuring optimum gate opening
 • The tape can be easily re-tensioned
Material: • Plastic
Colour: • Black

Art. No.	Unit	EAN
125H151391	1	4 014803 446558



Gate handle with hook turbomax®

- Spring travel limit:** • 8 cm
Advantage: • Extremely durable and compressible pressure spring
Material: • Polycarbonate
Fastening: • Eye for conductor material on handle
Colour: • Transparent yellow

Art. No.	Unit	EAN
125H15445010	1	4 014803 402509

CLEVER COMBINATION: GATE HANDLE & UNDERGROUND CABLE

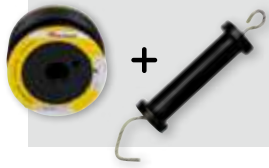

The current should never be transmitted through the gate handle and the conductor material in the gate. Especially when things need to move quickly, the gate handle often remains on the ground and is not immediately reattached. In this case, the current is diverted via the ground and the herding voltage in the fence drops. So, there is a risk that your animal will escape. Bridge the gate with a parallel installed underground cable.

Gate handle insulator with wooden thread

- Suitable for:** • All gate handles with hooks or eyes
Conductor material: • Rope, polywire, wire
Material: • Plastic, galvanized iron
Application: • For screwing in to wood and recycled plastic posts
Colour: • Black
Support: • Insulator support with thread for wood



Art. No.	Unit	EAN
125H15126	3	4 014803 456410



Gate handle insulator with metal plate

- Suitable for:** • All gate handles with hooks
Conductor material: • Wire up to 2,5 mm
Application: • For screwing or nailing on to wood and recycled plastic posts
Advantage: • Wire connection screws can be placed on the metal plate. This establishes a connection to other fence wires
Colour: • Black
Scope of delivery: • Metal plate
 • Plastic part with screws



Art. No.	Unit	EAN
125H15307	2	4 014803 405951

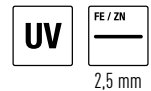

Gate handle set with spring

- Application:** • Especially suitable for easy opening and closing of gates through electrically conductive tension spring
Scope of delivery: • 1x gate handle turbomax with hook
 • 1x gate handle insulator
 • 1x ring insulator
 • Tension spring, galvanized, thick

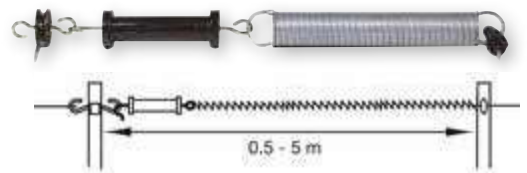

Art. No.	Design	Unit	EAN
125H15416	Kit	2	3 700393 916687
125H15487	Tension spring single, galvanized, thick	1	3 700393 916786



Gate handle set with rope

- Application:** • Especially suitable for easy opening and closing of gates without ground contact through electrically conductive rope
Scope of delivery: • 1x gate handle with hook
 • 1x rope: 4.50 m long (slack), 9.4 long (taut)
 • 1x gate handle insulator
 • 1x ring insulator

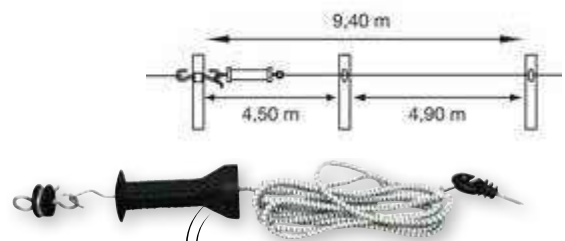

Art. No.	Unit	EAN
125H15316	1	4 014803 405937

CATTLE FARMING



These gate handle sets are designed for optimal use in cattle farming.

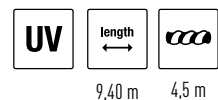

HORIZONT FENCE | Gates | Gate handle sets & Pasture gates

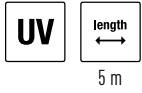

Gate handle set with thin spring

- Application:**
- Especially suitable for easy opening and closing of gates through electrically conductive tension spring
- Scope of delivery:**
- 1x gate handle farmer
 - 1x tension spring, galvanized, thin

Art. No.	Unit	EAN
125H15291	2	4 014803 420442

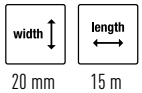

NEW Roller Gate ranger®

Gate handle set 20 mm, swivelling

- Application:**
- Gate for electric fences
 - Easy to open without the conductor material touching the ground, the tape is rolled up automatically
 - Can be swivelled when installed to the 2 sturdy metal holders and can therefore be used for 2 gates
 - Large pasture gates or double-row gates up to 7 m width are possible with the 15 m long tape
- Scope of delivery:**
- 1 x belt retractor, 1 x gate handle with tape connector, 2 x metal supports, 15 m tape 20 mm

Art. No.	Unit	EAN
125H14651	1	4 014803 146519



EXPERTS RECOMMEND THE USE OF HORIZONT UNDERGROUND CABLES HERE

With a gate, it is particularly important to install a parallel running underground cable. The underground cable keeps the fence electrified even when the gate is open. As a result, the energy from the fence is not discharged into the ground when the gate is open, so there is no risk to the herding security.



125H14040



—
**UKAL TECH
SELECTION**

- 330 **Cameras**
*Luda Farm
Horizont*
- 336 **Water pump**
*Hotline
Lorentz*



UKALTECH

UKAL TECH is the new branch of UKAL dedicated to technical and innovative products requiring support and advice from our experts. This division adapts to the specificities and constraints of breeders, their animals and their farms. Our aim is to meet their new expectations by offering expert and tailor-made solutions to improve production, the quality of life production, the quality of life of farmers and animal welfare. We focus on innovation and digitalization of farms. Do not hesitate to contact the dedicated team by phone or via their website. Find here a selection of UKAL TECH articles.

NEW

CAMERA FARMCAM MOBILITY S 4G

LUDA FARM



Where you have 3G/4G network coverage, you can set up FarmCam Mobility S. The camera has a motion detection sensor that will register and record activities that appear in front of the camera, and can record on the included 32 GB memory card. The camera comes with a pre-installed Nano SIM card. By activating the FarmCam Mobility S SIM-card in My.Luda.Farm you get a 1 GB free trial for 30 days. After the trial there are three subscriptions* to choose from: Small (0.1 GB), Medium (0.25 GB) or Large (2 GB). You can decide which subscription will suit you based on your consumption during the 30-day trial. You can activate and deactivate the subscription according to your needs on a monthly basis. The camera detects movement optimally when the object moves across the sensor detection zone. The PIR (passive infrared) sensor is triggered by changes in temperature in front of the camera. **The camera has a 16x digital zoom and 2560 x 1440 video resolution, giving you razor-sharp images in Full QHD quality (almost twice as sharp as Full HD).** FarmCam Mobility S has three power supply options. The camera can be powered by 230 V or the Luda.Farm solar panel during warmer months and sunshine.

Included in the package: 1 x FarmCam Mobility S camera. 1 x 1.5 m IP44 power adapter cable. 1 x Screw kit. 1 x Rubber protection. 1 x Rechargeable battery. 1 x Micro-SD card 32 GB. 1 x Nano SIM card pre-installed. 1 x Camera mount. 1 x Rubber mount. 1 x Screw pattern. 1 x Reset pin.

Sku. LUD1115 Farm Cam Mobility S 4G 

Sku. LUD1091 Luda SolarCharger FCM 



FARM CAM MOBILITY 4G**LUDA FARM**

Through its 3G/4G connection and rechargeable battery you can place FarmCam Mobility wherever there is mobile network coverage. Works Anywhere - Anytime. **FarmCam Mobility is the perfect surveillance solution in places where you don't have power or Wi-Fi connection.** Thanks to the rechargeable battery and SIM-card, you can monitor your property, machines, animals, etc. in remote areas. As long as you have mobile network coverage, you can setup the camera wherever you need it. Used together with the SolarCharger FCM you will not even have to think about recharging the battery. In other words, a truly mobile surveillance camera. The Smart Motion Sensor will register and record activities that appears in front of the camera. When the camera registers an activity, you will be informed through a notification in your smartphone or by e-mail. By distinguishing warm objects from tree branches that move in the wind, rain, flies, etc. the Smart Motion Sensor eliminates false alarms and ensures you are alerted to genuine situations. Other useful features that come with the camera are Zoom, Night Vision, Alarm and Two-Way Audio (mic/speaker). If the camera detects trespassers, you can act by talking to them directly or scare them off by triggering the Alarm function of the camera. Features:

- Use it wherever you have 3G/4G network coverage.
- Rechargeable battery, lasting up to 2 months depending on usage.
- SIM-card that automatically chooses the strongest network included. No settings needed: just Plug-n-Play.
- Rain/sun, day/night - place the camera wherever you want without worrying about the weather.
- Smart heat and movement sensor ensures you are alerted to genuine situations and eliminates false alarms.
- SD-card included for recording of motion events which you access through the FarmCam 2.0 App in your smartphone.

Sku. LUD1086 Farm Cam Mobility 4G **Limited stock** 7 350030 454636

Sku. LUD1091 Luda SolarCharger FCM 7 350030 454773



Solar panel for LUDA FARMCAM MOBILITY 4G and 360S

**NEW****CAMERA FARMCAM 360S****LUDA FARM**

Motorized Wi-Fi surveillance camera **with a 360° overview. FarmCam 360S is a mobile surveillance camera for both indoor and outdoor use that can cover 360 degrees.** The camera has a 16x digital zoom and a 2560x1440 video resolution, which gives you razor-sharp images in Full QHD quality (almost two times sharper than Full HD). FarmCam 360S can be powered by 230V or a Luda.Farm solar panel during warmer months and sunshine, plus temporary with its built-in rechargeable battery when needed. The camera needs Wi-Fi/Internet access for set-up and to be able to view live video in the FarmCam 2.0 App on your smartphone and tablet. The App is free of charge. It has dual-band functionality, which allow users to operate on both the 2.4GHz and 5GHz frequency band for maximum speed and efficiency. FarmCam 360S has motion detection alarm and can record on the 32GB memory card (included) upon motion detection and sends you a notification in the App on your phone or tablet. You can pan, tilt and zoom the camera in the App. FarmCam 360S has night vision, alarm plus microphone and a speaker with talk-back function built-in the camera. In the FarmCam 2.0 app you can talk with the person in front of the camera or use a recording of your voice to scare off an intruder.

- **Zoom numérique x16**
- 32GB memory card included.
- 2560x1440 QHD video resolution
- Microphone and a speaker with talk-back function
- Weatherproof to IP64
- Night vision (10 m)
- **Lens with a 122-degree field of view**
- Dual-band 2.4GHz and 5GHz functionality
- 230 V power adapter included. Can be operated on 230 V or temporarily with the built-in battery and Luda solar panel for the sunniest months.
- PIR motion detector with recording and alarm function.

Sku. LUD1116 FarmCam 360S 7 350030 455343

Sku. LUD1091 Luda SolarCharger FCM 7 350030 454773



The UKAL-Horizont group has chosen to make its know-how and technical experience available by developing a new segment dedicated to farm building and livestock surveillance.

To put together its new range of security cameras and accessories, the horizont group has worked with a long-standing partner specialised in the field and known for the high quality of its products.

High-performance cameras offering some of the best viewing angles on the market.



Système DORI

180 m	71 m	36 m	18 m
Detect	Observe	Recognise	Identify



Système DORI



53 m	23 m	11 m	2 m
Detect	Observe	Recognise	Identify

NEW



VISION 360° CAMERA 360°

Security camera for protecting and securing premises (industrial buildings, warehouses, farm buildings, etc.). It provides extensive coverage and a zoom function for more detailed images. Users can see what is happening **from any angle**, in the smallest detail, at any time.

Specification:

- Use in standalone mode or with the compatible recorder
- PoE /12V DC
- Micro SD card up to 256 GB optional
- Infrared projector 20 m
- Resolution: 4 megapixels 2560 x 440
- Built-in microphone
- Control with the Horizont-Live app (for iOS or Android)
- 0 to 355° pan
- 0 to 90° tilt
- Optical zoom x 4 (digital x 16)
- This kit contains: the camera and the mounting screws

Sku. HOR100122



NEW



VISION COLOUR SMART NIGHT VISION CAMERA

Smart security camera for protecting and securing premises (industrial buildings, warehouses, farm buildings, etc.). Features AcuSense technology for smart detection of vehicles and people and **ColorVu technology for colour night vision**.

Specification:

- Use in standalone mode or with the compatible recorder
- PoE /12V DC
- Micro SD card up to 256 GB optional
- White light projector included 40 m
- Resolution: 4 megapixels 2,688 x 1,520
- Control with the Horizont-Live app (for iOS or Android)
- Pan 112°
- Tilt 61°
- This kit contains: the camera and the mounting screws

Sku. HOR100121



NEW

 **horizont**
Warranty**CAMERA 360 ZOOM PRO**

Professional surveillance camera for building protection and security (industry, storage facilities, farms, etc.). It provides extensive coverage and can be zoomed in for greater detail.

Specification:

25× optical zoom and 16× digital zoom 25× optical zoom and 16× digital zoom provide close up views **over expansive areas**

High quality imaging (4 millions pixels)

Focuses on human and vehicle targets classification based on deep learning (AcuSence 2.0)

Excellent low-light performance with powered-by-DarkFighter technology

Stand-alone or **compatible with PoE 802at/ DC12V recorder**

Optional **micro SD card up to 256 GB**

Expansive night view with up to 100 m IR distance

Management via the horizont-live application (iOS & Android)

Viewing angle: 55° to 2.4°

Panoramic rotation: 360°

Tilt: -15° to 90°



Système DORI

			
2400 m	952 m	480 m	240 m
Detect	Observe	Recognise	Identify

Sku. HOR100124

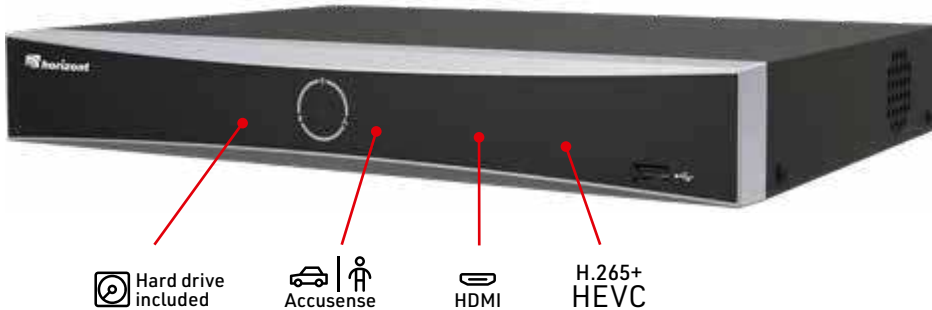

3 700393 983023

 Hard drive included Accusense HDMI H.265+ HEVC LED indicator lights -30°C
+70°C

NEW

 **horizont**
Warranty**VISION NETWORK VIDEO RECORDER
SMART VIDEO RECORDER**

4-channel video recorder for optimum surveillance of your buildings.

Specification:

Very high definition up to 12 million pixels

VGA output and HDMI 4K

Up to 4 IP cameras (PoE)

Control with the Horizont-Live app (for iOS or Android)

Smart, simple, user-friendly interface

Live viewing on a smartphone or computer

This kit contains: hard drive, HDMI cable, mouse, network cable

Sku. HOR100111



3 700393 977831

NEW

 **horizont**
Warranty**VISION BRIDGE
WIRELESS BRIDGE**

The wireless bridge provides a remote, wireless connection with a range of 5 kilometres in a totally clear area.

Specification:

5 GHz / 867 Mbps

Range up to 5 km

Built-in 12 dBi 2*2 MIMO antenna

IEEE 802.11 ac standard

1*10/100/1000 Mbps LAN

1*10/100/1000 Mbps Passive PoE LAN

Operating angle 40° horizont / 15° vertic

This kit contains: wireless bridge, PoE adapter, 12V power supply, 2 plastic ties, installation instructions

Sku. HOR100101



3 700393 977602

CAMERA KITS

We have developed a series of camera kits ready for you to sell in store that will meet the majority of your customers' needs.



NEW

WIRED KIT 1 CAMERA

Kit contains:

- NVR recorder
- Vision Colour camera

Sku. HORKIT100100



NEW

WIRELESS KIT 1 CAMERA

Kit contains:

- NVR recorder
- Vision Colour camera
- 2 Vision bridges

Sku. HORKIT100200



NEW

WIRELESS KIT 4 CAMERAS

Kit contains:

- NVR recorder
- 4 Vision Colour cameras
- 2 Vision bridges

Sku. HORKIT100250



TYPICAL INSTALLATIONS

1 CONNECTION TO THE FARM BY RJ45 CABLE

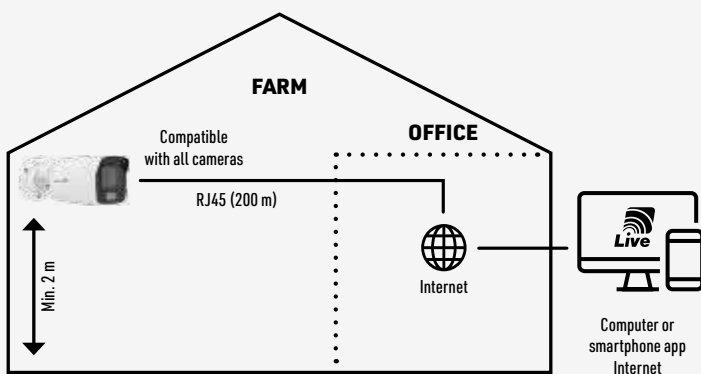

2 CONNECTION TO THE FARM VIA AN NVR BOX

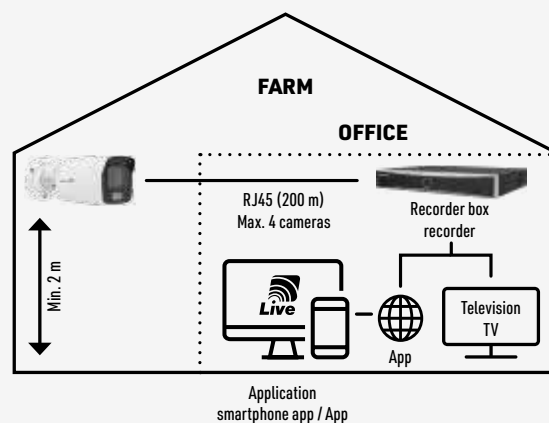

ADDITIONAL ACCESSORIES

NEW

MICROSDXC MEMORY CARD

- Directly compatible with the cameras
- Operating temperature: 0 to 70°C
- Micro-SD to SD adapter supplied

Sku. HOR100142



64 GB



NEW

6-PORT SWITCH

- 1 Hi-PoE IEEE 802.3at/af/bt port
- 3 standard IEEE PoE 802.3at/af ports
- 2 standard RJ45 ports
- Plug-and-Play installation
- Operating temperature: -10°C to +55°C

Sku. HOR100131



6 ports - Range: 300 m



NEW

WALL MOUNTING

To mount the Vision 360° camera vertically on a wall. Made of polycarbonate for excellent thermal resistance and mechanical strength. For indoor or outdoor use. The RJ45 and power cables pass inside the mounting.

Sku. HOR100123



Polycarbonate



NEW

MAINS POWER SUPPLY

Mains power cable for Vision Colour camera.

Sku. HOR100132



NEW

RJ45 CABLE

RJ45 F/UTP CAT6

- Anti-UV for outdoor use
- Colour: black

HOR100135-1

20 m



HOR100135-2

10 m



HOR100135-3

1 m



3 CONNECTION TO THE FARM VIA A WIRELESS BRIDGE

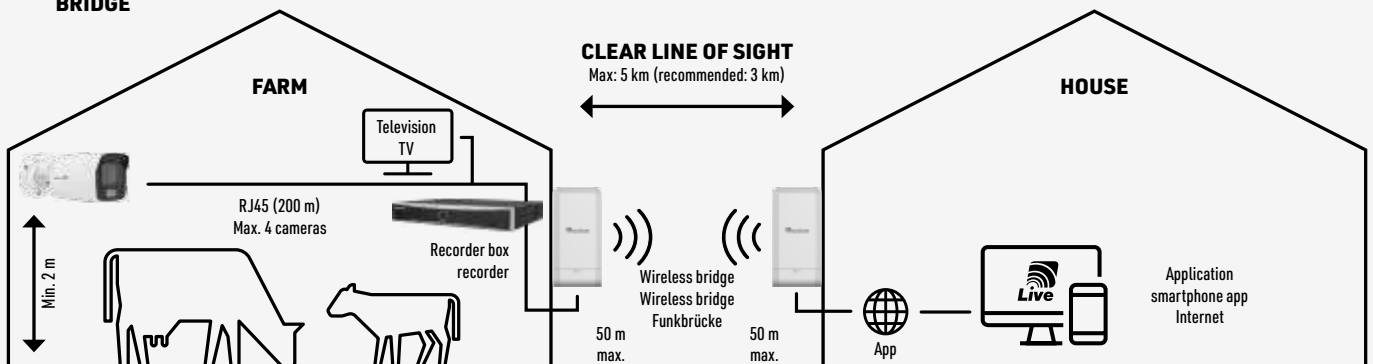



MEADOW PUMP KIT WITH SOLAR PANEL 60 W

Hotline
Electric Fencing

The complete meadow pump kit allows you to supply water to your pasture tank, avoiding water contamination by animal excrements but also stopping erosion of river and stream banks by cattle. An easy, reliable and autonomous way to provide water to livestock when watercourses are fenced off. This maintains water quality at a high level and preserves the healthy growth of local flora and fauna.

The complete prairie pump kit includes:

- 1 control box with compartment for 12V battery. **BATTERY NOT INCLUDED**
- 1 30 m hose with submersible pump
- 1 float switch
- 1 solar panel 60W **INCLUDED**

Its solar panel provides constant autonomy for this meadow pump kit. The polypropylene battery compartment is very weather resistant and can hold a 12V/85 Ah battery (not included). For optimal operation of your meadow pump, we recommend the use of an 85 Ah battery. Farmers increasingly need to keep their livestock away from waterways. The European Water Framework Directive (WFD) establishes a framework for the protection of inland waters, transitional waters (estuaries), coastal waters and groundwater. River fencing provides protection against bank erosion. Solar battery-powered meadow pump kits can be integrated into all common drinking troughs. The solar pump provides the animals with their water needs without having to change or recharge the battery (depending on storage density, weather conditions, etc.). These kits are simple 12 V pumping systems based on water pump technology to allow the transfer of large quantities of water. The kit is equipped with a float that activates the submersible pump when the water level drops. The pump is connected to a 30 m long hose that leads directly from the water source to the tank. The set is powered by a 12 V battery (not included in the kit) located in a weatherproof housing. We recommend an 85 Ah battery. The water requirements of the animals are very different and are influenced by temperature, humidity and type of feed, among other things. The majority of grazing animals are herd animals and want to drink together, so the size of the drinking trough should allow for this. By increasing the height, the pumping capacity is reduced. At a height of 10 m the pump is running at about 65% of its maximum performance. The charging times of the solar energy vary according to the weather conditions. Keep in mind that in summer the water needs of the animals increase. The water requirements are indicative. Make sure to follow the instructions for use.



Sku. 119150

Meadow pump kit with solar panel



FIND OUR VIDEO ON YOUTUBE

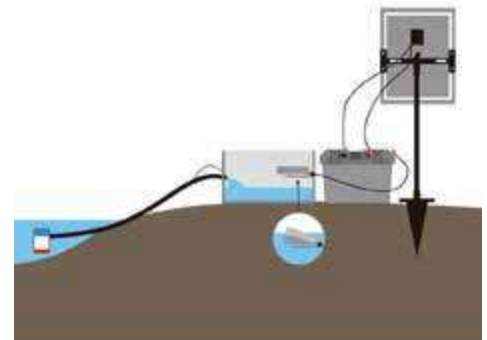
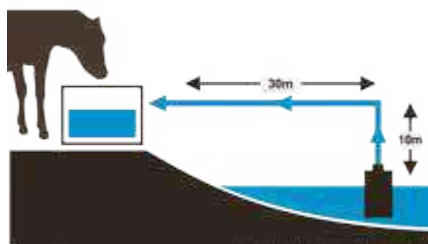

MEADOW PUMP KIT WITH HOSE AND FLOAT



The complete Meadow pump kit includes: 1 control box with compartment for 12 V battery (battery not included), 1 30 m hose with submersible pump, 1 float switch.

Sku. 119150001 

Meadow pump kit with hose and float



SOLAR PANEL 60 W WITH SUPPORT



This 60W solar panel with support is suitable for the meadow pump kit. This element allows to gain autonomy and to ensure a permanent water supply in the pasture tank. A real economic gain!

- Highly efficient crystalline solar module
- Adjustable aluminium support
- Developed for connection to the meadow pump kit - without charge controller
- Dimensions: 685 x 670 x 35 mm.

Sku. 119150002 

Meadow pump kit with solar panel



BATTERY 85 AH FOR MEADOW PUMP

Battery 85Ah ideal for meadow pump. Ready to use.

Sku. 119150004 

85Ah (C100)
70Ah (C20)



Non-contractual visual

To request a personalised quote, you can contact customer service **UKAL TECH** on **03 88 90 73 93** via the **ukal.com** form 

NEW

SOLAR PUMP



This solar powered submersible water pump is ideal for pumping water directly from any source (wells, streams, ponds...). It can be used for various applications: watering livestock, irrigating crops, drinking water... **This pump works thanks to the sun, without any battery, without any other energy source.**

The S1-200 system includes:

- Helical rotor pump with high efficiency DC brushless motor pre-attached 15 m (50 ft) motor cable to plug into the controller
- S1-200 mini controller with accessory inputs for dry run protection and tank full switch
- PV module adapter to use any standard PV module (max. 55 VDC)

Additional accessories required (not included):

- Solar panel 120W: ref.119150105 *2
- Floats: ref. 119150140

Other complementary accessories (not included):

- Pump extension: ref.119150141
- Probe extension: ref.119150142

Sku. 119150130  Depth: up to 18 m
Water volume per day: up to 23 m³/d

Sku. 119150120  Depth: up to 27 m
Water volume per day: up to 14 m³/d

Sku. 119150110  Depth: up to 40 m
Water volume per day: up to 7 m³/d



NEW

LORENTZ

FLOATS FOR LORENTZ SOLAR MEADOW PUMPS

Two floats for LORENTZ solar meadow pumps for dry run protection and automatic tank filling monitoring (Tank Full Switch).

Sk. 119150140



Dry Run Protection :
15 m Tank Full Switch
: 10 m"



NEW

LORENTZ

MOTOR EXTENSION CABLE 20 M FOR MEADOW PUMP

Cable with plugs to extend the motor cable on S1-200 systems. The S1-200 Motor Extension Cable is used to extend the motor cable on S1-200 pump systems. The cable has two 3-pin male and female push lock/ twist type connector.

Sk. 119150141



20 m



NEW

LORENTZ

SOLAR PANEL FOR LORENTZ MEADOW PUMP

This 120W solar panel will fit perfectly with the LORENTZ meadow pumps (ref. 119150110 ; ref. 119150120 ; ref. 119150130). It will generate enough solar energy to ensure an optimal functioning of these pumps and thus ensure a permanent water supply for the cattle in the pastures. Please note that for optimal use of these pumps, 2 panels of 120 watts are required, 240W of power.

Sk. 119150105



120 W



NEW

LORENTZ

ACCESSORY EXTENSION CABLE FOR MEADOW PUMP

Cable with plugs to extend the Tank Full Switch and Dry Run Protection. The S1 - Accessory Extension Cable is used to extend the Tank Full Switch and the Dry Run Protection cable on S1 pump systems. The cable has two M16 male and female 2-pin connectors.

Sk. 119150142



20 m





UKAL

—
**UKAL GREEN
SELECTION**

- 340 SKAZA
- 342 EKO'PIN
- 343 FERTIGALLI
- 344 PORTLAND GARDEN
- 345 KWASAR

Compost



NEW

COMPOST BIN ORGANKO DAILY

The perfect addition to your kitchen, this compact and stylish waste collector ensures hassle-free separation of biodegradable waste, helping you minimize your ecological footprint effortlessly. Simple one-hand emptying. Bokashi Organko circular story of bio-waste. Easy cleaning all parts dishwasher-safe. Made from post-consumer recycled plastics. **Made in Europe.**

Sku. 803200001	Light grey - 3,3 L	3 830073 322726
Sku. 803200002	Black - 3,3 L	3 830073 322733



NEW

COMPOSTER BOKASHI ORGANKO 2

Bokashi is a mixture of molasses (sugar and water) and natural beneficial microorganisms (lactic acid bacteria, yeast fungus, photosynthetic organisms, actinomycetes and enzyme active fungus) that initiates fermentation process and prevents decay in the Bokashi Organko 2 composter. Bokashi Organko 2 gives each organic waste a new purpose. During fermentation, you get the first-class compost base and bokashi liquid. The volume of organic waste is reduced by 25%. Bokashi Organko 2 is made from recycled plastics (recycled polypropylene). Set composition : lid, presser, internal container, external container, carrying handle, tap, dosage container. Biogene included. **Made in Europe. Capacity: 9.6 L.**



NEW

COMPOSTER BOKASHI ORGANKO 2 OCEAN

Bokashi Organko 2 Ocean A revolutionary kitchen composter made from hand-picked and recycled fishing nets. The Bokashi Organko 2 Ocean composter is a sustainable solution for a zero-waste lifestyle and urban ecological gardening while solving the organic waste issue. With this kitchen composter, you can easily produce first-class base for compost, fertilizer for your urban garden and a natural detergent for drains. Also, you can reduce the volume of organic waste by 25%. Valuable microorganisms contained in the bokashi bran trigger fermentation, thus preventing food from rotting. Bokashi Organko 2 is the star of next-generation products for responsible environmental management. It is made out of recycled, environmentally friendly and safe materials. Its state-of-the-art design makes it possible for you to place it in the centre of every kitchen. Set composition : lid, presser, internal container, external container, carrying handle, tap, dosage container. Biogene included. **Made from recycled recycled fishing nets. Made in Europe. Capacity: 9.6 L.**



Sku. 803150002	Black	3 830073 322160
-----------------------	-------	-----------------



Sku. 803150001	White cream	3 830073 322177
-----------------------	-------------	-----------------



Sku. 803150004	Cappucino	3 830073 322191
-----------------------	-----------	-----------------



Sku. 803150008	Olive green	3 830073 322184
-----------------------	-------------	-----------------



NEW



KIT 1 ORGANKO ESSENTIAL BOKASHI BIN WITH SKAZA BIOGEN

Bokashi is a mixture of molasses (sugar and water) and natural beneficial microorganisms (lactic acid bacteria, yeast fungus, photosynthetic organisms, actinomycetes and enzyme active fungus) that initiates fermentation process and prevents decay in the Bokashi Organko Essential composter. Bokashi Organko Essential gives each organic waste a new purpose. During fermentation, you get the first-class compost base and bokashi liquid. The volume of organic waste is reduced by 25%. Bokashi Organko Essential is made from post-consumer recycled plastics (recycled polypropylene). Composition of 1 kit + base : Lid, handle, container, tap, draining sieve, dosage container, presser, drainer cup, base. Biogene included. **Capacity: 15.3 litres. Made in Europe.**

Sku. 803100002	Black	
Sku. 803100011	Grey	



NEW



KIT 2 ORGANKO ESSENTIAL BOKASHI BINS WITH SKAZA BIOGEN

Bokashi is a mixture of molasses (sugar and water) and natural beneficial microorganisms (lactic acid bacteria, yeast fungus, photosynthetic organisms, actinomycetes and enzyme active fungus) that initiates fermentation process and prevents decay in the Bokashi Organko Essential composter. Bokashi Organko Essential gives each organic waste a new purpose. During fermentation, you get the first-class compost base and bokashi liquid. The volume of organic waste is reduced by 25%. Bokashi Organko Essential is made from post-consumer recycled plastics (recycled polypropylene). Composition of 2 kits + base : 2 * Lid, 2 * handle, 2 *container, 2 *tap, 2 *draining sieve, 1 *dosage container, 1 *presser, 1 *drainer cup, 1 *base. Biogene included. **Capacity: 15.3 litres. Made in Europe.**

Sku. 803100102	Black	
-----------------------	-------	--



NEW



BIOGEN FOR BOKASHI

Biogen, a natural organic bran for biological waste, made from biogenic material, activated by effective microorganisms. It does not contain genetically modified organisms. Capacity: 1 kg. Composition : Various biogenic materials, sugar syrup, beneficial effective microorganisms and minerals.

Sku. 803100	1 kg		
--------------------	------	--	--



EKO' PIN

CLEANING PRODUCTS THAT COMBINE *efficiency and ecology*



NEW



INDOOR AND
OUTDOOR RANGE



ECO-FRIENDLY
PACKAGING



French market only. Please enquire if you need any information.



UKAL.com



The Fertigalli brand was born in the heart of the Doubs department. By transforming the droppings from its hens into granules, the Kolly henhouse, a family-run free-range laying hen farm, is creating a new 100% natural, dry, clean and practical organic fertiliser, enabling consumers to do something to protect the planet while reviving an age-old practice.



NEW

CHICKEN MANURE FERTILIZER



Made from chicken manure, Fertigalli is a traditional fertilizer that is 100% natural, effective and easy to use. Fertigalli is an excellent fertilizer, providing a complete supply of nutrients to the soil. It decomposes slowly and is gradually assimilated by the plants. Rich in trace elements, chicken manure enriches the soil with organic matter and stimulates micro-organisms. The pellets can be used in organic farming and do not contain any chemical substances. They are safe for humans, plants and animals.

Sku. 820100	4 kg	3 770022 617001
Sku. 820200	15 kg	3 770022 617018

Composition :

86% dry matter; 2.22% P2O2 (Phosphorus); 0.916% MgO (Magnesium); 3.5% N (Nitrogen) of which 3.46% organic nitrogen; 2.52% K2O (Potassium); 8.5% C/N; 6.62% CaO (Calcium). Organic fertilizer according to NFU 42-001 - Can be used in organic agriculture according to EU regulation 2018/848.

How to use :

A few handfuls of pellets mixed into the soil and it's done! 50 to 100 g for pot crops (7 to 15 m²/kg) and 0.5 T to 3 T/ha for field crops. These doses are given as an indication and may vary according to the nature of the soil. Store under cover.

NEW

BIG BAG



Products only available on request. Bulk purchase possible from 5 tonnes.

Sku. 820400	500 kg	3 700393 978593
Sku. 820500	1000 kg	3 700393 978609

FARMING IN THE HEART OF NATURE



With respect for animal welfare, the hens are reared in the open air and fed on local cereals.



Made from 100% hen droppings, Fertigalli fertiliser is natural and can be used in organic farming.



It enriches the soil with organic matter and stimulates micro-organisms.



Environmentally friendly, it contains no chemicals.





Since 1946, Portland Garden has been number 1 in the UK garden market. The company expanded internationally after obtaining ferric phosphate approvals, notably for France. Today, UKAL is the exclusive distributor for the French market, with a wide range of products for home and garden maintenance.



For outdoor spaces

NEW

BLACK SOAP



Portland Garden black soap is made from olive oil. **Used in Organic Agriculture**, it can be used to clean a wide range of outdoor surfaces and care for plants. This concentrated liquid black soap will also be your perfect ally for cleaning, degreasing and shining all the surfaces in your home. all the surfaces in your home.



Sku. 129567  5 013655 217711

750 ml - Ready-to-use 

Sku. 129567001  5 013655 217735

1 L - Concentrated formula 

NEW



COPPER STRIP

Adhesive copper tape can be used to protect your pots, planters and tubs against slugs. Ready to use and easy to install, it emits a static discharge. **For use in organic gardening.**



Sku. 129561200  5 013655 217322

4 m x 3 cm 



THE OTHER PORTLAND GARDEN PRODUCTS ARE ONLY FOR FRENCH MARKET. IF YOU HAVE ANY QUESTIONS OR INTEREST, PLEASE CONTACT US.



Sprayers

NEW

Beaumont

SPRAY GUN

Spray gun. **8 adjustable spray patterns.** Durable metal construction. Impacted-resistant plastic trigger and TPR comfort grip. Plastic adaptor included.

Sku. 123395



8 adjustable spray patterns



MERCURY SUPER 360 TRIGGER SPRAYER



Practical and multifunctional. Adjustable nozzle for perfect spray control. Double action trigger: 1 x squeeze = 2 x release jet (easy spray function). Ergonomic hand grip. 360° system, works in any position, even upside down. Transparent scale on the tank for filling level control. Made of high-impact plastic. Durable base ring to stabilise and protect the sprayer.

Sku. 129903



1 l



ORION SUPER COMPRESSION SPRAYER



Practical, reliable, multifunctional sprayers. For professional farming, hobby farming, home and garden. Safety valve for perfect pressure control. Glass fibre telescopic lance, adjustable from 60 to 120 cm. Handy funnel for easy tank filling. Ergonomic belt. Transparent scale on the tank for filling level control. Made of high-impact plastic. Durable base ring to stabilize and protect the sprayer. With additional base ring feed to help pumping. 5-year tank warranty.

Sku. 129901



6 l



VENUS SUPER 360 PRESSURE SPRAYER



Practical and multifunctional. Unique modern design. Safety valve for perfect pressure control. Articulated spray tip for hard-to-access places. Ergonomic hand grip. 360° system, works in any position, even upside down. Transparent scale on the tank for filling level control. Made of high-impact plastic. Durable base to for stabilise and protect the sprayer. 3-year tank warranty.

Sku. 129902001



1 l



Sku. 129902015



1.5 l



Sku. 129902020



2 l



NEPTUNE SUPER KNAPSACK SPRAYER



Practical, reliable, multifunctional. Ideal for long jobs. Unique modern design. Handle with working pressure gauge under permanent control. Glass fibre telescopic lance, adjustable from 60 to 120 cm. Practical for right and lefthanders. Handle and lance can be placed in an upright position at the side of the tank. Easy tank filling. Ergonomically shaped tank and padded straps. Transparent scale on the tank for filling level control. Made of high-impact plastic. 6-year tank warranty.

Sku. 129900



15 l



MAINTAIN YOUR OUTDOOR SPACES EASILY



→ For more information, see page 112 in the UKAL catalog

INDEX

A

Adhesive hoof tape 38
 Adhesive tape for films 121
 Aluminium spray 10
 Ankle strap for cows 75
 Antahi feeder 16
 Antifouling disc 151
 Anti-kick bar 29
 Anti-moult grooming glove 167
 Applicator for rubber ring 57
 Applicator for eartags 74
 Applicator for calf weaners 27
 Artery forceps 11
 Automatic doorman for chicken coop 142
 Automatic drinker for chicken 149
 Automatic rabbit drinking trough 160

B

Baling twine 111
 Barnes dehorner 25
 Batteries 240, 349
 Bell 49, 60, 61
 Biogen for bokashi 353
 Black soap 356
 Blade set 84
 Blanket for calves 9
 Blanket for horse 171
 Block for harness 78
 Blocks for demotec easybloc 36
 Bloodless castrator 26, 56
 Blue spray 10
 Bokashi 353
 Bolus gun 22
 Bone saw with screw 133
 Boot cleaner 105
 Boots 172
 Bottle holder drinking trough 159
 Bracket for bucket 12, 111
 Braided wires and ropes 213
 Bridle bracket 111
 Broom 112
 Brush 17, 46, 47, 48, 165, 166, 179
 Bucket 14, 19, 45, 108, 147
 Bulb 69
 Bull holder 28
 Bull rings 28
 Butter churn 125

C

Cable 216
 Cage trap 196, 198
 Calf collar 33
 Calf dummy 14
 Calf feeder 15, 18
 Calf weaner 27
 Calving gloves 9
 Calving gown 105
 Calving jack 8
 Calving ropes 8
 Cameras 342, 343, 345, 346
 Cane 29
 Cannula for syringes 99
 Cannulas for hoof care adhesive 37
 Captive bolt stunner 66
 Carabiner 120
 Carder 48
 Cartridges for captive bolt stunners 66
 Catch hook 58
 Catheter 41
 Cattle counter 118
 Chain 14
 Chick feeder 144, 148
 Chicken coop door opener 142
 Clamp for wings 158
 Cleaver 133
 Clipper 55, 82, 83, 84, 90, 91
 Clipper for horse 83
 Clipper oil 93

Coconut husk chips poultry litter 142
 Cohesive flexible bandage 38
 Collar for cow 33, 49, 76
 Collar for sheep 61, 75
 Colostrum bags 17, 54
 Colostrum scale 15
 Comb 47, 87, 88, 89, 90
 Compost bin 352
 Conditioning spray 183
 Connection for ropes 217
 Connection for tape 217
 Control cover without seal 44
 Cool spray for comb 93
 Cow brush 48
 Cow lift 10
 Crane scale 118
 Cream separator 124
 Cresyl bactericidal disinfectant fungicide 114

D

Dairy apron 105
 Dairy brush 46
 Dairy sleeves 105
 Dehorner 24, 56
 Dehorning paste 25
 Dehorning pen 25
 Dehorning saw wire 25
 Dehorning saw wire handles 25
 Demotec 90 36
 Depilator 40
 Detangler 162
 Detergent 106, 114
 Diatomaceous earth 143
 Dip cup 40
 Disc for hoof care 34
 Disk filters 43
 Disposable overalls 104
 Disposable overboots 104
 Dosing cup 41
 Drencher 101
 Drenching gun 98, 99, 101
 Drinker 145, 149
 Drinker bucket 149
 Drinking bowl 107
 Drinking pipette for rabbit 159
 Drinking trough 145, 150, 152
 Dummy 13
 Dutch bowl 19

E

Ear notcher 78
 Eartags 72, 74
 Earth rod 222, 274
 Egg candler 140
 Eggs 143
 Energizer 211, 212, 213, 214
 Eutra 42
 Ewespoon with ties 52

F

Feed bucket 109
 Feeder 18, 110, 144, 146, 147, 151, 148, 154
 Feeding bucket 12
 Feeding cup 116
 Fence pliers 222
 Fence polywire 296, 297, 298
 Fence tape 292
 Fence tester 276
 Fence tester 222
 Fencing kit 224
 Fish oil with 100% cod liver oil 64
 Fleece 86, 170
 Flexi-tub 110
 Fly buckets 204
 Fly mask 169
 Fly protection tape reel 204
 Fly ribbon kit 205
 Fly swatter 201
 Fly tapes 205
 Fly trap 200
 Foal manger 110
 Food slicer 129
 Fork 113, 114, 136

G

Gas cannon bird scarere 196
 Gas cartridge 23
 Gate handle 220, 326, 327, 328
 Gloves 9, 104
 Glycerine soap 175
 Grain mill with barrel 155
 Grids for meat mincer reber 132
 Grip folding stool 112
 Gripple 302
 Grooming box 168
 Guide paddle 66

H

Hairnet 104
 Halter 31, 32, 33, 162
 Handle 47, 113, 117
 Harness for rams 78
 Hay rack 111
 Hay rake 114
 Head gate for sheep 58
 Head lift 26
 Headcollar 163
 Heating plate for chicks 140
 Himalayan salt block 174
 Hobble 29
 Hoof balm 173
 Hoof care adhesive 37
 Hoof checker 36
 Hoof cutter 34
 Hoof disc 34
 Hoof knife 35, 59
 Hoof mat 39
 Hoof oil with brush 172, 173
 Hoof ointment 173
 Hoof rasp 174
 Hoof scraper 34, 174
 Hoof shears 59
 Hoof tar 39, 173, 193
 Hoof trimmer 174
 Hoofmat 38, 105
 Hook 120, 121
 Horsefly spray 200

I

Identification strap digits 76
 Incubators 138, 139
 Insect killer 201, 202, 203
 Insulating tube 323
 Insulator 218, 219, 325, 327, 321, 322, 323, 324, 325
 Intravenous set 99
 Introducer for magnets 22
 Ir protector 68

K

Kit for colostrum 17
 Kitchen scale 118
 Knee pad 26, 56
 Knives 133, 134, 135
 Knives for meat mincer 132

L

Lamb feeder 52, 54
 Leads 30, 31
 Leather care 175
 Leg splint for calves 38
 Lubricating gel 10

M

Manger 109, 110
 Marker 74
 Marking numbers 0-9 79
 Marking spray 77
 Marking stick 78
 Massage gloves 167
 Mastitis detection kit 41

Meadow pump	350	Rain gauge	119	Tape strainer	217
Meat mincer	127	Ram apron	58	Tapes	211, 215, 291, 292
Milk can	45	Rat trap	187, 191, 192	Tar bandage « certoplast »	38
Milk heater	20, 21	Reactive liquid	41	Tattooing ink	79
Milk sampler dipper	45	Reel	223, 303	Tattooing paste	79
Milk thermometer	20	Refractometer	15	Teat	13, 14, 53, 19, 54
Milking cup	41	Repeller	192	Teat plug for milking liners	43
Milking grease	42	Ring hoof knife	35	Tendon boots	172
Milking pail	45	Ropes	213, 215, 293, 294	Tensioner	302
Mole trap	188, 189, 193	Rubber rings	57	Thermal bag for colostrum bag	17
Mouse trap	186, 190, 191	Ruminal magnets	22	Thermometer	11, 119, 130
Multi bolus gun	22			Tie rope	164
Muzzle	20			Tips for dehorner	24
				Tissues	40
N		S		Tomato mill machine	127
Needles	102	Saddle rack	111	Tooth cutting nipper	64
Nesting boxes	143	Salt lick holder	111	Transport cage	157
Netting	225, 286, 279, 280, 281, 226	Sausage filling machine	128	Traps	194, 195, 187
		Scalpel blade no. 22	64	Treats for horses	174
		Scissors	11, 93	Triangular pig staples	65
		Scoop	115, 116	Trigger hook	120, 121
		Scraper	115, 169	Trimmer	92
		Scratchnaal™ pad	66	Tripod drinker	147, 150
		Screw-in aid	323	Trocar	22
		Shafts	113, 117	Trusti tuber	16, 54
		Shampoo for dogs	182, 183		
		Sharpening paste	93	U	
		Sharpening stone	36	Udder towels	40
		Shearing plant	85	Ukaltag applicator	74
		Sheep ewespoon	52	Ultrasonic rodent repeller	190
		Sheep hoof knife	59		
		Sheep hoof shears	59	V	
		Sheep marking fluid	79	Vaccum machines	130
		Sheep shears	55	Vacuum bags and rolls	131
		Shepherd leg crook	57	Vaseline oil	93, 101
		Shepherd stovel	58	Visitor's kit	104
		Shepherd's knife	60	Vole traps	192
		Shovel	116		
		Smoker	129	W	
		Snares	194	Wall mounting	347
		Solar mole repeller	193	Wall thermometer	119
		Solar panel	349, 350	Warning signs for electric fencing	222, 274
		Solar pump	349	Washers	12
		Speedy feeder	15	Weasel box	197
		Sponge	168	Weightband	101
		Spray gun	357	Whisk	21
		Sprayer	41, 114, 357	Wire strainer with spring	217
		Squeegee	115	Wires	211, 213, 300
		Stable rug	171	Wolf deterrent netting	283, 284
		Stablemate	168	Wooden blocks	37
		Steel catch hook	57	Wrapping set	60
		Stethoscope	11		
		Strap for cows	75	Z	
		Sucking preventor ring	27	Zinc oxide ointment spray	10
		Swivel hook	120		
		Syringe	97, 98, 99, 100, 101		
		T			
		Tailwell MK2	83		
		Tank set for automatics guns	99		



UKAL

2024

JANUARY

1	Mon	JOUR DE L'AN	1
2	Tue		
3	Wed		
4	Thu		
5	Fri		
6	Sat		
7	Sun		
8	Mon		
9	Tue		
10	Wed		
11	Thu		
12	Fri		
13	Sat		
14	Sun		
15	Mon		
16	Tue		
17	Wed		
18	Thu		
19	Fri		
20	Sat		
21	Sun		
22	Mon		
23	Tue		
24	Wed		
25	Thu		
26	Fri		
27	Sat		
28	Sun		
29	Mon		
30	Tue		
31	Wed		

FEBRUARY

1	Thu		
2	Fri		
3	Sat		
4	Sun		
5	Mon		
6	Tue		
7	Wed		
8	Thu		
9	Fri		
10	Sat		
11	Sun		
12	Mon		
13	Tue		
14	Wed		
15	Thu		
16	Fri		
17	Sat		
18	Sun		
19	Mon		
20	Tue		
21	Wed		
22	Thu		
23	Fri		
24	Sat		
25	Sun		
26	Mon		
27	Tue		
28	Wed		
29	Thu		

MARCH

1	Fri		
2	Sat		
3	Sun		
4	Mon		
5	Tue		
6	Wed		
7	Thu		
8	Fri		
9	Sat		
10	Sun		
11	Mon		
12	Tue		
13	Wed		
14	Thu		
15	Fri		
16	Sat		
17	Sun		
18	Mon		
19	Tue		
20	Wed		
21	Thu		
22	Fri		
23	Sat		
24	Sun		
25	Mon		
26	Tue		
27	Wed		
28	Thu		
29	Fri	VENDREDI SAINT	
30	Sat		
31	Sun	PÂQUES	

APRIL

1	Mon	LUNDI DE PÂQUES	
2	Tue		
3	Wed		
4	Thu		
5	Fri		
6	Sat		
7	Sun		
8	Mon		
9	Tue		
10	Wed		
11	Thu		
12	Fri		
13	Sat		
14	Sun		
15	Mon		
16	Tue		
17	Wed		
18	Thu		
19	Fri		
20	Sat		
21	Sun		
22	Mon		
23	Tue		
24	Wed		
25	Thu		
26	Fri		
27	Sat		
28	Sun		
29	Mon		
30	Tue		

MAY

1	Wed	FÊTE DU TRAVAIL	18
2	Thu		
3	Fri		
4	Sat		
5	Sun		
6	Mon		
7	Tue		
8	Wed	VICTOIRE 1945	19
9	Thu	ASCENSION	
10	Fri		
11	Sat		
12	Sun		
13	Mon		
14	Tue		
15	Wed		
16	Thu		
17	Fri		
18	Sat		
19	Sun	PENTECÔTE	
20	Mon	LUNDI DE PENTECÔTE	
21	Tue		
22	Wed		
23	Thu		
24	Fri		
25	Sat		
26	Sun		
27	Mon		
28	Tue		
29	Wed		
30	Thu		
31	Fri		

JUNE

1	Sat		
2	Sun		
3	Mon		
4	Tue		
5	Wed		
6	Thu		
7	Fri		
8	Sat		
9	Sun		
10	Mon		
11	Tue		
12	Wed		
13	Thu		
14	Fri		
15	Sat		
16	Sun		
17	Mon		
18	Tue		
19	Wed		
20	Thu		
21	Fri		
22	Sat		
23	Sun		
24	Mon		
25	Tue		
26	Wed		
27	Thu		
28	Fri		
29	Sat		
30	Sun		

UKAL

2024

JULY

1 Mon	
2 Tue	
3 Wed	27
4 Thu	
5 Fri	
6 Sat ☾	
7 Sun	
8 Mon	
9 Tue	
10 Wed	28
11 Thu	
12 Fri	
13 Sat	
14 Sun ☀ FETERNATIONALE	
15 Mon	
16 Tue	
17 Wed	29
18 Thu	
19 Fri	
20 Sat	
21 Sun ☾	
22 Mon	
23 Tue	
24 Wed	30
25 Thu	
26 Fri	
27 Sat	
28 Sun ☀	
29 Mon	
30 Tue	
31 Wed	31

AUGUST

1 Thu	
2 Fri	
3 Sat	
4 Sun ☾	
5 Mon	
6 Tue	
7 Wed	
8 Thu	32
9 Fri	
10 Sat	
11 Sun	
12 Mon ☀	
13 Tue	
14 Wed	33
15 Thu ASSUMPTION	
16 Fri	
17 Sat	
18 Sun	
19 Mon ☾	
20 Tue	
21 Wed	34
22 Thu	
23 Fri	
24 Sat	
25 Sun	
26 Mon ☀	
27 Tue	
28 Wed	35
29 Thu	
30 Fri	
31 Sat	

SEPTEMBER

1 Sun	
2 Mon	
3 Tue ☾	
4 Wed	
5 Thu	
6 Fri	
7 Sat	
8 Sun	
9 Mon	
10 Tue	
11 Wed ☀	
12 Thu	
13 Fri	
14 Sat	
15 Sun	
16 Mon	
17 Tue	
18 Wed ☾	
19 Thu	
20 Fri	
21 Sat	
22 Sun	
23 Mon	
24 Tue ☀	
25 Wed	
26 Thu	
27 Fri	
28 Sat	
29 Sun	
30 Mon	

OCTOBER

1 Tue	
2 Wed ☾	
3 Thu	
4 Fri	
5 Sat	
6 Sun	
7 Mon	
8 Tue	
9 Wed	
10 Thu ☀	
11 Fri	
12 Sat	
13 Sun	
14 Mon	
15 Tue	
16 Wed	
17 Thu ☾	
18 Fri	
19 Sat	
20 Sun	
21 Mon	
22 Tue	
23 Wed	
24 Thu ☀	
25 Fri	
26 Sat	
27 Sun	
28 Mon	
29 Tue	
30 Wed	
31 Thu	

NOVEMBER

1 Fri ☾ TOUSSAINT	
2 Sat	
3 Sun	
4 Mon	
5 Tue	
6 Wed	
7 Thu	
8 Fri	
9 Sat ☀	
10 Sun	
11 Mon ARMISTICE 1918	
12 Tue	
13 Wed	
14 Thu	
15 Fri ☾	
16 Sat	
17 Sun	
18 Mon	
19 Tue	
20 Wed	
21 Thu	
22 Fri	
23 Sat ☀	
24 Sun	
25 Mon	
26 Tue	
27 Wed	
28 Thu	
29 Fri	
30 Sat	

DECEMBER

1 Sun ☾	
2 Mon	
3 Tue	
4 Wed	
5 Thu	
6 Fri	
7 Sat	
8 Sun ☀	
9 Mon	
10 Tue	
11 Wed	
12 Thu	
13 Fri	
14 Sat	
15 Sun ☾	
16 Mon	
17 Tue	
18 Wed	
19 Thu	
20 Fri	
21 Sat	
22 Sun ☀	
23 Mon	
24 Tue	
25 Wed NOËL	
26 Thu ST-ETIENNE	
27 Fri	
28 Sat	
29 Sun	
30 Mon ☾	
31 Tue	



UKAL

THE LEGACY OF A PASSION

UKAL ELEVAGE

Parc économique de la Sauer
2 rue de l'Étang
CS 50244 Eschbach
67892 Niederbronn-les-Bains
France
Tél.: +33 3 88 07 40 15
ukatel@ukal.com
www.ukal.com

POLAND ROLOS

Ul. Henryka Sienkiewicza 2
Wyszków
PL 07-200
Polska
rolos@horizont.com.pl
Tel.: +48 29 742 33 39
www.horizont.com.pl

AFTER SALES SERVICES

sav@ukal.com
Tél.: 03 88 90 73 93

UKAL INTERNATIONAL

Tél.: +33 3 88 07 40 16
Fax: +33 3 88 07 40 14
export@ukal.com

SLOVENIA HORIZONT CLAIR D.O.O. TRGOVSKO PODJETJE D.O.O.

Zbilje 4 H
1215 SL - Medvode
Slovenien
Tel.: +386 (0) 1 3617 606
Fax: +386 (0) 1 3617 607
info@clair.si
www.agro-clair.si

GERMANY HORIZONT ANIMAL CARE

Homberger Weg 4-6
34497 Korbach
Germany
Tel.: +49 (0) 5631/565-100
animalcare@horizont.com
animalcare.horizont.com

UNITED KINGDOM HOTLINE ELECTRIC FENCING

2 Roundhead Road
Heathfield Industrial Estate
Newton Abbot
Devon TQ12 6UE
United Kingdom
Tel: +44 (0) 1626 33 11 88
Fax: +44 (0) 1626 33 18 10
sales@hotline-fencing.co.uk
hotline.horizont.com

UKAL CANADA INC.

7525 rue Pion
J2R 1R8
St Hyacinthe
Québec / Canada
Tél.: (450) 796-1414
Fax: (450) 796-1415
Sans frais : 1 800 665 8389
info@ukal.ca



UKAL.com

